



// STANDARD FITTINGS

// FERRULES.....	48	// NPTF INSERTS.....	84
// HOSE MENDER.....	53	// NPSM INSERTS.....	86
// BSP INSERTS.....	54	// ORFS INSERTS.....	87
// DIN METRIC INSERTS.....	61	// FRENCH INSERTS.....	91
// PRESSURE WASHER.....	73	// JIS INSERTS.....	92
// SAE INSERTS.....	74	// KOMATSU INSERTS.....	94
// JIC 37° INSERTS.....	76	// SAE FLANGES.....	96

// FERRULES

// H1200TX2

No-Skive Ferrule for 3TE, R5 and Flexopak 2 Minetuff 2 1/2" - 241T Hi-tuff hoses

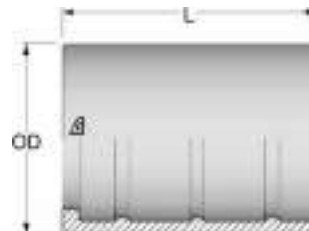

Item Code	Product Code	ID (Dash)	ID (mm)	ID (in)	Ferrule OD (mm)	L (mm)
1236581	H1200TX2-030000	3	5,0	3/16"	21,0	20,0
1236582	H1200TX2-040000	4	6,0	1/4"	23,0	24,7
1236583	H1200TX2-050000	5	8,0	5/16"	25,0	24,7
1236584	H1200TX2-060000	6	10,0	3/8"	27,0	29,7
1236585	H1200TX2-080000	8	13,0	1/2"	30,0	30,5
1236586	H1200TX2-100000	10	16,0	5/8"	34,0	35,5
1236587	H1200TX2-120000	12	19,0	3/4"	38,0	36,0
1236588	H1200TX2-160000	16	25,0	1"	48,0	42,5
1236589	H1200TX2-200000	20	31,0	1 1/4"	53,0	56,5
1236590	H1200TX2-240000	24	38,0	1 1/2"	60,0	61,5
1236591	H1200TX2-320000	32	51,0	2"	76,0	73,5
1236592	H1200TX2-400000	40	63,0	2 1/2"	89,0	85,0

// H1200TX4

No-Skive Ferrule for R4 Hoses (604, 634, 644)

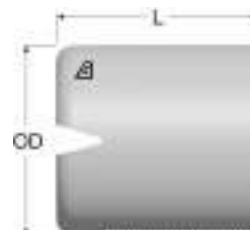

Item Code	Product Code	ID (Dash)	ID (mm)	ID (in)	Ferrule OD (mm)	L (mm)
1250572	H1200TX4-120000	12	19,0	3/4"	36,0	39,0
1250581	H1200TX4-160000	16	25,0	1"	42,4	44,3
1250582	H1200TX4-200000	20	31,0	1 1/4"	50,0	53,2
1250583	H1200TX4-240000	24	38,0	1 1/2"	55,0	60,2
1250584	H1200TX4-320000	32	51,0	2"	70,0	73,2
1250585	H1200TX4-400000	40	63,0	2 1/2"	83,0	86,0

Design and dimensions shown may be changed without prior notice

// H1200103

No-Skive Ferrule for PLT

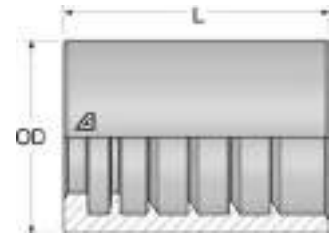

Item Code	Product Code	ID (Dash)	ID (mm)	ID (in)	Ferrule OD (mm)	L (mm)
1202932	H1200103-030000	3	5,0	3/16"	17,0	23,0
1201351	H1200103-040000	4	6,0	1/4"	19,0	26,3

// H1200AD1

No-Skive Ferrule for 1 Wire Braid and 2 Wire Braid Compact Hoses

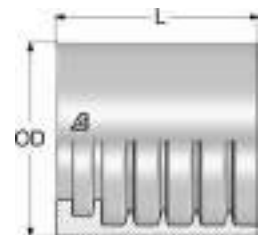

Item Code	Product Code	ID (Dash)	ID (mm)	ID (in)	Ferrule OD (mm)	L (mm)
1227977	H1200AD1-030000	3	5,0	3/16"	19,0	24,0
1227978	H1200AD1-040000	4	6,0	1/4"	22,0	24,7
1227979	H1200AD1-050000	5	8,0	5/16"	23,0	24,7
1227980	H1200AD1-060000	6	10,0	3/8"	26,0	29,7
1227981	H1200AD1-080000	8	13,0	1/2"	29,0	30,5
1227983	H1200AD1-100000	10	16,0	5/8"	32,0	30,5
1227985	H1200AD1-120000	12	19,0	3/4"	36,0	36,0
1227986	H1200AD1-160000	16	25,0	1"	44,0	36,7
1227987	H1200AD1-200000	20	31,0	1 1/4"	53,0	48,6
1227988	H1200AD1-240000	24	38,0	1 1/2"	61,0	48,6
1227989	H1200AD1-320000	32	51,0	2"	75,0	48,6

// H1200AD2

No-Skive Ferrule for 2SN

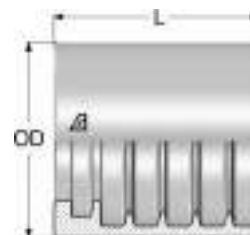

Item Code	Product Code	ID (Dash)	ID (mm)	ID (in)	Ferrule OD (mm)	L (mm)
1227990	H1200AD2-030000	3	5,0	3/16"	21,0	20,0
1227991	H1200AD2-040000	4	6,0	1/4"	23,0	24,7
1227992	H1200AD2-050000	5	8,0	5/16"	25,0	24,7
1227993	H1200AD2-060000	6	10,0	3/8"	27,0	29,7
1227994	H1200AD2-080000	8	13,0	1/2"	30,0	30,5
1227995	H1200AD2-100000	10	16,0	5/8"	33,0	30,5
1227996	H1200AD2-120000	12	19,0	3/4"	37,0	36,0
1227997	H1200AD2-160000	16	25,0	1"	45,0	36,7
1227998	H1200AD2-200000	20	31,0	1 1/4"	56,0	48,6
1227999	H1200AD2-240000	24	38,0	1 1/2"	64,0	48,5
1228000	H1200AD2-320000	32	51,0	2"	78,0	48,6

// H1200204

No-Skive Ferrule for Alfabiotech/Powerflexbio Hoses

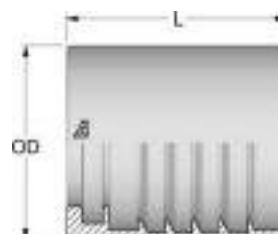

Item Code	Product Code	ID (Dash)	ID (mm)	ID (in)	Ferrule OD (mm)	L (mm)
1216588	H1200204-060000	6	10,0	3/8"	30,0	28,0
1216589	H1200204-080000	8	13,0	1/2"	34,0	33,9
1216590	H1200204-100000	10	16,0	5/8"	38,0	36,6
1203322	H1200204-120000	12	19,0	3/4"	42,0	39,5
1203323	H1200204-160000	16	25,0	1"	50,0	47,5
1216591	H1200204-200000	20	31,0	1 1/4"	61,0	50,2

Design and dimensions shown may be changed without prior notice

// H1200TP0

No-Skive Ferrule for Thermoplastic and 1 Wire Braid Compact Hoses

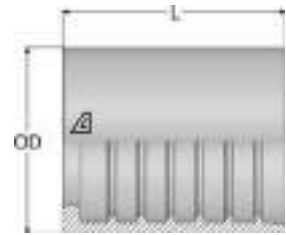

Item Code	Product Code	ID (Dash)	ID (mm)	ID (in)	Ferrule OD (mm)	L (mm)
1232354	H1200TP0-030000	3	5,0	3/16"	15,0	22,0
1232358	H1200TP0-040000	4	6,0	1/4"	17,0	26,5
1232359	H1200TP0-050000	5	8,0	5/16"	19,0	26,5
1232360	H1200TP0-060000	6	10,0	3/8"	22,0	26,5
1232361	H1200TP0-080000	8	13,0	1/2"	26,0	30,5

// H2200TF0

No-Skive Ferrule for PTFE Hoses

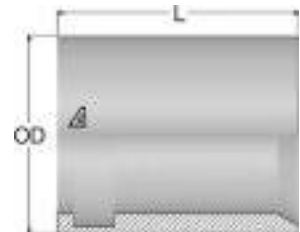

Item Code	Product Code	ID (Dash)	ID (mm)	ID (in)	Ferrule OD (mm)	L (mm)
1232132	H2200TF0-030000	3	5,0	3/16"	14,0	20,0
1232133	H2200TF0-040000	4	6,0	1/4"	15,0	25,0
1232134	H2200TF0-050000	5	8,0	5/16"	17,2	25,0
1232135	H2200TF0-060000	6	10,0	3/8"	22,0	25,0
1232136	H2200TF0-080000	8	13,0	1/2"	25,0	30,0
1232137	H2200TF0-100000	10	16,0	5/8"	30,0	33,0
1232138	H2200TF0-120000	12	19,0	3/4"	35,0	37,0
1232139	H2200TF0-160000	16	25,0	1"	42,0	45,0
1232140	H2200TF0-200000	20	31,0	1 1/4"	50,0	48,0
1232141	H2200TF0-240000	24	38,0	1 1/2"	57,0	58,0
1232142	H2200TF0-320000	32	51,0	2"	73,0	67,0

// H1100SK1

Skive Ferrule for 1 Wire Braid and 2 Wire Braid Compact Hoses
No-Skive for 1TE, 2TE and R6

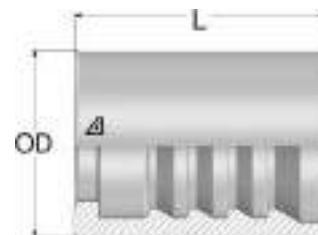

Item Code	Product Code	ID (Dash)	ID (mm)	ID (in)	Ferrule OD (mm)	L (mm)
1233077	H1100SK1-040000	4	6,0	1/4"	19,0	25,5
1233078	H1100SK1-050000	5	8,0	5/16"	21,0	25,5
1233079	H1100SK1-060000	6	10,0	3/8"	23,0	27,5
1233080	H1100SK1-080000	8	13,0	1/2"	27,0	33,5
1233081	H1100SK1-100000	10	16,0	5/8"	30,0	36,5
1233082	H1100SK1-120000	12	19,0	3/4"	33,0	40,0
1233083	H1100SK1-160000	16	25,0	1"	41,0	46,5

// H1100104

Skive Ferrule for 1SN

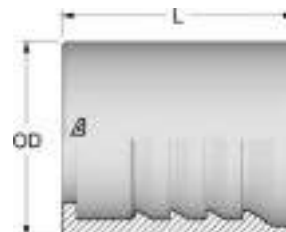

Item Code	Product Code	ID (Dash)	ID (mm)	ID (in)	Ferrule OD (mm)	L (mm)
1201545	H1100104-200000	20	31,0	1 1/4"	50,0	43,8
1201546	H1100104-240000	24	38,0	1 1/2"	57,0	49,2
1201547	H1100104-320000	32	51,0	2"	71,0	63,7

// H1100404

Skive Ferrule for 2/3 Wire Braid and Wire Spiral Hoses

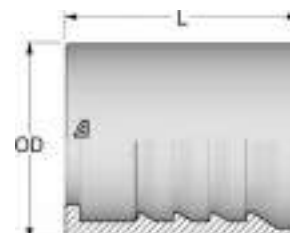

Item Code	Product Code	ID (Dash)	ID (mm)	ID (in)	Ferrule OD (mm)	L (mm)
1202719	H1100404-040000	4	6,0	1/4"	22,0	26,3
1203253	H1100404-060000	6	10,0	3/8"	25,0	28,5
1203266	H1100404-080000	8	13,0	1/2"	29,0	34,7
1219132	H1100404-100000	10	16,0	5/8"	33,0	37,5
1203368	H1100404-120000	12	19,0	3/4"	37,0	41,5
1234701	H1100404-160000	16	25,0	1"	45,0	47,7
1234766	H1100404-200000	20	31,0	1 1/4"	55,0	54,5
1234767	H1100404-240000	24	38,0	1 1/2"	67,0	61,1
1234768	H1100404-320000	32	51,0	2"	82,0	75,1

Design and dimensions shown may be changed without prior notice

// HOSE MENDER

// H12C5610

Hose Mender

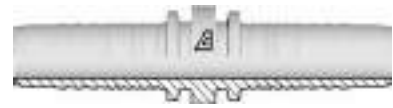

Item Code	Product Code	ID (Dash)	ID (mm)	ID (in)
1202949	H12C5610-040400	4	6,0	1/4"
1202870	H12C5610-050500	5	8,0	5/16"
1202868	H12C5610-060600	6	10,0	3/8"
1202867	H12C5610-080800	8	13,0	1/2"
1203160	H12C5610-101000	10	16,0	5/8"
1203161	H12C5610-121200	12	19,0	3/4"
1220608	H12C5610-161600	16	25,0	1"
1220607	H12C5610-202000	20	32,0	1 1/4"
1220605	H12C5610-242400	24	38,0	1 1/2"
1220606	H12C5610-323200	32	51,0	2"

// BSP INSERTS

// H1210510

**BSP Male 60° Flare
AGR**

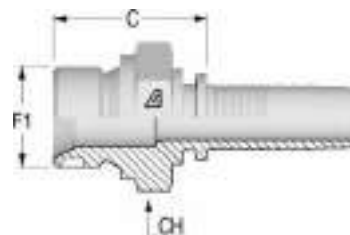

Item Code	Product Code	ID (Dash)	ID (mm)	ID (in)	F1 Dash	F1	C (mm)	CH (mm)
1201291	H1210510-030200	3	5,0	3/16"	2	1/8-28	20,3	14,0
1201722	H1210510-040200	4	6,0	1/4"	2	1/8-28	20,8	14,0
1200507	H1210510-040400	4	6,0	1/4"	4	1/4-19	26,3	19,0
1200508	H1210510-040600	4	6,0	1/4"	6	3/8-19	27,8	22,0
1201098	H1210510-040800	4	6,0	1/4"	8	1/2-14	31,3	27,0
1200540	H1210510-050400	5	8,0	5/16"	4	1/4-19	26,3	19,0
1200541	H1210510-050600	5	8,0	5/16"	6	3/8-19	27,8	22,0
1201101	H1210510-050800	5	8,0	5/16"	8	1/2-14	31,3	27,0
1200340	H1210510-060400	6	10,0	3/8"	4	1/4-19	26,3	19,0
1200341	H1210510-060600	6	10,0	3/8"	6	3/8-19	27,8	22,0
1200339	H1210510-060800	6	10,0	3/8"	8	1/2-14	31,3	27,0
1200386	H1210510-080600	8	13,0	1/2"	6	3/8-19	28,6	22,0
1200384	H1210510-080800	8	13,0	1/2"	8	1/2-14	32,1	27,0
1201096	H1210510-081000	8	13,0	1/2"	10	5/8-14	34,1	30,0
1200385	H1210510-081200	8	13,0	1/2"	12	3/4-14	36,1	32,0
1201085	H1210510-100800	10	16,0	5/8"	8	1/2-14	32,1	27,0
1200419	H1210510-101000	10	16,0	5/8"	10	5/8-14	34,1	30,0
1200418	H1210510-101200	10	16,0	5/8"	12	3/4-14	36,1	32,0
1200446	H1210510-121200	12	19,0	3/4"	12	3/4-14	36,6	32,0
1201095	H1210510-121600	12	19,0	3/4"	16	1-11	41,6	41,0
1201355	H1210510-161600	16	25,0	1"	16	1-11	43,4	41,0
1201356	H1210510-162000	16	25,0	1"	20	1 1/4-11	46,4	50,0
1201357	H1210510-202000	20	32,0	1 1/4"	20	1 1/4-11	48,0	50,0
1201358	H1210510-242400	24	38,0	1 1/2"	24	1 1/2-11	51,0	55,0
1201359	H1210510-323200	32	51,0	2"	32	2-11	56,5	70,0

// H1210610

**BSP Male Flat Seat
AGR FD**

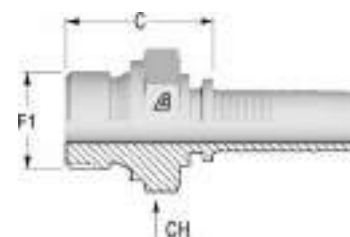

Item Code	Product Code	ID (Dash)	ID (mm)	ID (in)	F1 Dash	F1	C (mm)	CH (mm)
1214181	H1210610-040400	4	6,0	1/4"	4	1/4-19	26,3	19,0
1223423	H1210610-060600	6	10,0	3/8"	6	3/8-19	27,8	22,0
1216596	H1210610-060800	6	10,0	3/8"	8	1/2-14	31,3	27,0
1225012	H1210610-080800	8	13,0	1/2"	8	1/2-14	32,1	27,0

Design and dimensions shown may be changed without prior notice

// H1210710

BSPT Male

AGR K

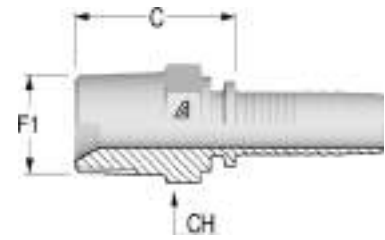

Item Code	Product Code	ID (Dash)	ID (mm)	ID (in)	F1 Dash	F1	C (mm)	CH (mm)
1200456	H1210710-030200	3	5,0	3/16"	2	1/8-28	20,8	12,0
1200491	H1210710-040200	4	6,0	1/4"	2	1/8-28	21,3	12,0
1200490	H1210710-040400	4	6,0	1/4"	4	1/4-19	26,8	17,0
1200492	H1210710-040600	4	6,0	1/4"	6	3/8-19	27,8	19,0
1200532	H1210710-050400	5	8,0	5/16"	4	1/4-19	26,8	17,0
1200533	H1210710-050600	5	8,0	5/16"	6	3/8-19	27,8	19,0
1200328	H1210710-060400	6	10,0	3/8"	4	1/4-19	26,8	17,0
1200329	H1210710-060600	6	10,0	3/8"	6	3/8-19	27,8	19,0
1200327	H1210710-060800	6	10,0	3/8"	8	1/2-14	32,3	22,0
1200373	H1210710-080600	8	13,0	1/2"	6	3/8-19	28,6	19,0
1200371	H1210710-080800	8	13,0	1/2"	8	1/2-14	33,1	22,0
1200410	H1210710-101200	10	16,0	5/8"	12	3/4-14	34,1	27,0
1200440	H1210710-121200	12	19,0	3/4"	12	3/4-14	34,6	27,0
1200439	H1210710-121600	12	19,0	3/4"	16	1-11	43,6	36,0
1201365	H1210710-161200	16	25,0	1"	12	3/4-14	37,4	32,0
1201361	H1210710-161600	16	25,0	1"	16	1-11	44,4	36,0
1201363	H1210710-202000	20	32,0	1 1/4"	20	1 1/4-11	49,0	46,0
1201364	H1210710-242400	24	38,0	1 1/2"	24	1 1/2-11	50,5	50,0
1201360	H1210710-323200	32	51,0	2"	32	2-11	54,2	65,0

// H1220813

**BSPF Female 60° Cone with O-Ring
DKOR**

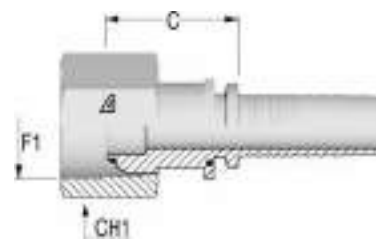

Item Code	Product Code	Nut Type	ID (Dash)	ID (mm)	ID (in)	F1 Dash	F1	C (mm)	CH1 (mm)
1200606	H1220511-030200	Crimped	3	5,0	3/16"	2	1/8-28	14,3	14,0
1202325	H1220813-030400	Slip on nut	3	5,0	3/16"	4	1/4-19	20,3	19,0
1201066	H1220511-040200	Crimped	4	6,0	1/4"	2	1/8-28	14,7	14,0
1202326	H1220813-040400	Slip on nut	4	6,0	1/4"	4	1/4-19	20,8	19,0
1202327	H1220813-040600	Slip on nut	4	6,0	1/4"	6	3/8-19	23,3	22,0
1202328	H1220811-050400	Crimped	5	8,0	5/16"	4	1/4-19	16,6	19,0
1202329	H1220813-050600	Slip on nut	5	8,0	5/16"	6	3/8-19	23,3	22,0
1202330	H1220811-060400	Crimped	6	10,0	3/8"	4	1/4-19	17,3	19,0
1202331	H1220813-060600	Slip on nut	6	10,0	3/8"	6	3/8-19	23,3	22,0
1202332	H1220813-060800	Slip on nut	6	10,0	3/8"	8	1/2-14	24,3	27,0
1202571	H1220811-080600	Crimped	8	13,0	1/2"	6	3/8-19	18,6	22,0
1202333	H1220813-080800	Slip on nut	8	13,0	1/2"	8	1/2-14	25,1	27,0
1202334	H1220813-081000	Slip on nut	8	13,0	1/2"	10	5/8-14	28,4	27,0
1202335	H1220813-081200	Slip on nut	8	13,0	1/2"	12	3/4-14	29,0	32,0
1202457	H1220811-101000	Crimped	10	16,0	5/8"	10	5/8-14	17,1	27,0
1202336	H1220813-101200	Slip on nut	10	16,0	5/8"	12	3/4-14	29,0	32,0
1202462	H1220811-121200	Crimped	12	19,0	3/4"	12	3/4-14	20,6	32,0
1202337	H1220813-121600	Slip on nut	12	19,0	3/4"	16	1-11	34,0	38,0
1202455	H1220811-161600	Crimped	16	25,0	1"	16	1-11	23,9	38,0
1202338	H1220813-162000	Slip on nut	16	25,0	1"	20	1 1/4-11	39,4	50,0
1202458	H1220812-202000	Thrust wire nut	20	32,0	1 1/4"	20	1 1/4-11	32,0	50,0
1202339	H1220813-202400	Slip on nut	20	32,0	1 1/4"	24	1 1/2-11	41,9	55,0
1202463	H1220812-242400	Thrust wire nut	24	38,0	1 1/2"	24	1 1/2-11	33,8	55,0
1202340	H1220813-243200	Slip on nut	24	38,0	1 1/2"	32	2-11	47,0	70,0
1202014	H1220812-323200	Thrust wire nut	32	51,0	2"	32	2-11	34,0	70,0

Image: insert with Slip on Nut.

Codes with root "H1220511" are without O-ring

Design and dimensions shown may be changed without prior notice

// H1220843
45° BSP Female 60° Cone with O-Ring
DKOR 45
Solid one piece

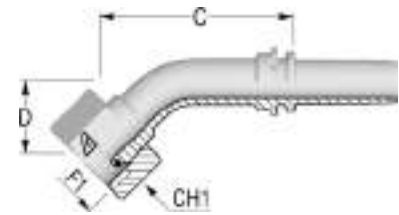

Item Code	Product Code	Nut Type	ID (Dash)	ID (mm)	ID (in)	F1 Dash	F1	C (mm)	D Drop (mm)	CH1 (mm)
1202341	H1220843-040400	Slip on nut	4	6,0	1/4"	4	1/4-19	45,5	15,0	19,0
1202342	H1220843-040600	Slip on nut	4	6,0	1/4"	6	3/8-19	41,5	17,5	22,0
1214200	H1220841-050400	Crimped	5	8,0	5/16"	4	1/4-19	19,0	17,5	19,0
1202343	H1220843-050600	Slip on nut	5	8,0	5/16"	6	3/8-19	45,1	18,5	22,0
1202344	H1220843-060600	Slip on nut	6	10,0	3/8"	6	3/8-19	49,9	20,5	22,0
1202345	H1220843-060800	Slip on nut	6	10,0	3/8"	8	1/2-14	45,7	21,0	27,0
1202346	H1220843-080800	Slip on nut	8	13,0	1/2"	8	1/2-14	55,0	21,0	27,0
1202347	H1220843-081000	Slip on nut	8	13,0	1/2"	10	5/8-14	57,2	23,0	27,0
1202348	H1220843-081200	Slip on nut	8	13,0	1/2"	12	3/4-14	56,7	23,0	32,0
1202464	H1220841-101000	Crimped	10	16,0	5/8"	10	5/8-14	64,0	21,5	27,0
1202349	H1220843-101200	Slip on nut	10	16,0	5/8"	12	3/4-14	66,5	22,5	32,0
1202465	H1220841-121200	Crimped	12	19,0	3/4"	12	3/4-14	70,0	28,0	32,0
1202350	H1220843-121600	Slip on nut	12	19,0	3/4"	16	1-11	74,6	31,5	38,0
1202466	H1220841-161600	Crimped	16	25,0	1"	16	1-11	84,0	34,0	38,0
1216663	H1220843-162000	Slip on nut	16	25,0	1"	20	1 1/4-11	97,0	47,5	50,0
1202467	H1220842-202000	Slip on nut	20	32,0	1 1/4"	20	1 1/4-11	101,0	40,0	50,0
1202468	H1220842-242400	Thrust wire nut	24	38,0	1 1/2"	24	1 1/2-11	116,0	46,0	55,0
1202469	H1220842-323200	Thrust wire nut	32	51,0	2"	32	2-11	152,0	60,0	70,0

Image: insert with Slip on Nut.

// H1220893
90° BSPP Female 60° Cone with O-Ring
DKOR 90
Solid one piece

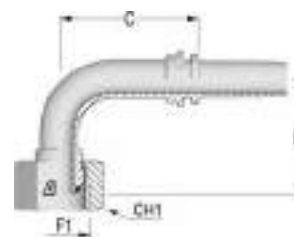

Item Code	Product Code	Nut Type	ID (Dash)	ID (mm)	ID (in)	F1 Dash	F1	C (mm)	D Drop (mm)	CH1 (mm)
1200607	H1220591-030200	Crimped	3	5,0	3/16"	2	1/8-28	24,0	30,0	14,0
1201707	H1220591-040200	Crimped	4	6,0	1/4"	2	1/8-28	30,5	32,0	14,0
1202367	H1220893-040400	Slip on nut	4	6,0	1/4"	4	1/4-19	29,3	29,0	19,0
1202353	H1220893-040600	Slip on nut	4	6,0	1/4"	6	3/8-19	29,8	31,0	22,0
1202354	H1220893-050600	Slip on nut	5	8,0	5/16"	6	3/8-19	33,2	36,0	22,0
1202355	H1220893-060600	Slip on nut	6	10,0	3/8"	6	3/8-19	34,8	42,0	22,0
1202356	H1220893-060800	Slip on nut	6	10,0	3/8"	8	1/2-14	34,3	35,5	27,0
1202881	H1220891-080600	Crimped	8	13,0	1/2"	6	3/8-19	35,3	43,0	22,0
1202357	H1220893-080800	Slip on nut	8	13,0	1/2"	8	1/2-14	35,8	41,0	27,0
1202358	H1220893-081000	Slip on nut	8	13,0	1/2"	10	5/8-14	41,6	43,5	27,0
1202359	H1220893-081200	Slip on nut	8	13,0	1/2"	12	3/4-14	41,8	43,0	32,0
1202470	H1220891-101000	Crimped	10	16,0	5/8"	10	5/8-14	47,9	47,0	27,0
1202360	H1220893-101200	Slip on nut	10	16,0	5/8"	12	3/4-14	51,9	49,0	32,0
1202471	H1220891-121200	Crimped	12	19,0	3/4"	12	3/4-14	49,1	53,0	32,0
1202361	H1220893-121600	Slip on nut	12	19,0	3/4"	16	1-11	54,1	60,5	38,0
1202475	H1220891-161600	Crimped	16	25,0	1"	16	1-11	75,1	69,0	38,0
1202362	H1220893-162000	Slip on nut	16	25,0	1"	20	1 1/4-11	75,1	88,5	50,0
1202472	H1220892-202000	Slip on nut	20	32,0	1 1/4"	20	1 1/4-11	82,0	83,0	50,0
1202363	H1220893-202400	Slip on nut	20	32,0	1 1/4"	24	1 1/2-11	101,0	83,0	55,0
1202456	H1220892-242400	Thrust wire nut	24	38,0	1 1/2"	24	1 1/2-11	96,0	96,0	55,0
1202364	H1220893-243200	Slip on nut	24	38,0	1 1/2"	32	2-11	107,8	104,0	70,0
1202473	H1220892-323200	Thrust wire nut	32	51,0	2"	32	2-11	128,0	136,0	70,0

Image: insert with Slip on Nut.

// H1220581
90° Compact BSPP Female 60° Cone
DKR 90

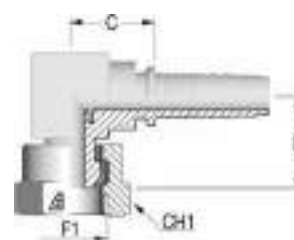

Item Code	Product Code	Nut Type	ID (Dash)	ID (mm)	ID (in)	F1 Dash	F1	C (mm)	D Drop (mm)	CH1 (mm)
1202422	H1220581-040400	Crimped	4	6,0	1/4"	4	1/4-19	16,8	19,5	19,0
1202025	H1220581-060600	Crimped	6	10,0	3/8"	6	3/8-19	18,8	22,0	22,0
1202026	H1220581-060800	Crimped	6	10,0	3/8"	8	1/2-14	21,5	22,5	27,0
1202027	H1220581-080800	Crimped	8	13,0	1/2"	8	1/2-14	22,6	24,5	27,0
1203213	H1220581-121200	Crimped	12	19,0	3/4"	12	3/4-14	26,7	31,0	32,0
1203330	H1220581-1616B0	Crimped	16	25,0	1"	16	1-11	34,6	37,5	38,0

Design and dimensions shown may be changed without prior notice

// H1220613

BSPF Female Flat Seat DKR FD

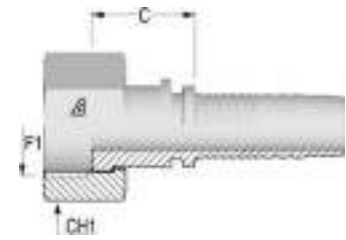

Item Code	Product Code	Nut Type	ID (Dash)	ID (mm)	ID (in)	F1 Dash	F1	C (mm)	CH1 (mm)
1202226	H1220613-040400	Slip on nut	4	6,0	1/4"	4	1/4-19	20,3	19,0
1202227	H1220613-060600	Slip on nut	6	10,0	3/8"	6	3/8-19	20,3	22,0
1202140	H1220613-060800	Slip on nut	6	10,0	3/8"	8	1/2-14	20,8	27,0
1202228	H1220613-080800	Slip on nut	8	13,0	1/2"	8	1/2-14	21,6	27,0
1202229	H1220613-081200	Slip on nut	8	13,0	1/2"	12	3/4-14	24,6	32,0
1201684	H1220611-101200	Crimped	10	16,0	5/8"	12	3/4-14	17,6	32,0
1201570	H1220611-121200	Crimped	12	19,0	3/4"	12	3/4-14	18,1	32,0
1216659	H1220611-121600	Crimped	12	19,0	3/4"	16	1-11	20,6	38,0
1201384	H1220611-161600	Crimped	16	25,0	1"	16	1-11	19,9	38,0

Image: insert with Slip on Nut.

// H1230310

BSPF Banjo - RNR

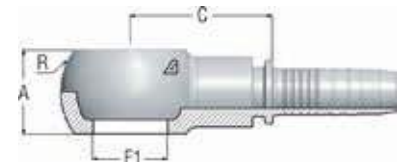

Item Code	Product Code	ID (Dash)	ID (mm)	ID (in)	F1	C (mm)	R (mm)	A (mm)
1203087	H1230310-040200	4	6,0	1/4"	1/8-28	20,0	17	10
1203086	H1230310-040400	4	6,0	1/4"	1/4-19	26,5	22	14
1216840	H1230310-040600	4	6,0	1/4"	3/8-19	30,5	28	18
1201763	H1230310-050600	5	8,0	5/16"	3/8-19	30,5	28	18
1201760	H1230310-060600	6	10,0	3/8"	3/8-19	24,3	28	18
1201754	H1230310-060800	6	10,0	3/8"	1/2-14	34,5	38	22
1203048	H1230310-080800	8	13,0	1/2"	1/2-14	35,0	38	22
1216843	H1230310-080600	8	13,0	1/2"	3/8-19	30,5	28	18
1203085	H1230310-101000	10	16,0	5/8"	5/8-14	38,0	40	24
1200423	H1230310-121200	12	19,0	3/4"	3/4-14	41,5	46	29
1203084	H1230310-161600	16	25,0	1"	1-11	50,5	58	36

// H10V0210

BSP Bolt

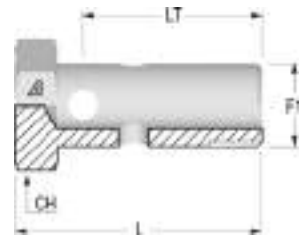

Item Code	Product Code	F1 Dash	F1	LT (mm)	L1 (mm)	CH (mm)
1210366	H10V0210-040000	4	1/4-19	25	30,0	19,0
1210367	H10V0210-060000	6	3/8-19	31	38,0	22,0
1210365	H10V0210-080000	8	1/2-14	38	46,0	27,0
1210404	H10V0210-100000	10	5/8-14	42	51,0	28,0
1210403	H10V0210-120000	12	3/4-14	47	56,0	32,0
1210402	H10V0210-160000	16	1-11	58	69,0	38,0

Design and dimensions shown may be changed without prior notice

// DIN METRIC INSERTS

// H1211110

Metric Male 24° Seat
DIN 3853 - Light Series
CEL

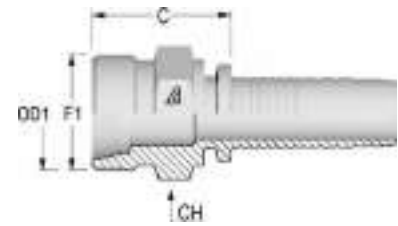

Item Code	Product Code	ID (Dash)	ID (mm)	ID (in)	F1	OD1	C (mm)	CH (mm)
1200451	H1211110-031200	3	5,0	3/16"	M12X1.5	6	20,8	14,0
1201558	H1211110-041600	4	6,0	1/4"	M16X1.5	10	23,3	17,0
1200482	H1211110-041400	4	6,0	1/4"	M14X1.5	8	21,3	14,0
1200481	H1211110-041200	4	6,0	1/4"	M12X1.5	6	21,3	14,0
1200518	H1211110-051600	5	8,0	5/16"	M16X1.5	10	23,3	17,0
1201086	H1211110-051800	5	8,0	5/16"	M18X1.5	12	24,3	19,0
1200314	H1211110-061600	6	10,0	3/8"	M16X1.5	10	23,3	17,0
1200315	H1211110-061800	6	10,0	3/8"	M18X1.5	12	24,3	19,0
1200320	H1211110-062200	6	10,0	3/8"	M22X1.5	15	25,3	22,0
1200362	H1211110-082600	8	13,0	1/2"	M26X1.5	18	27,1	27,0
1202565	H1211110-081800	8	13,0	1/2"	M18X1.5	12	25,1	19,0
1200358	H1211110-082200	8	13,0	1/2"	M22X1.5	15	26,1	22,0
1200401	H1211110-102600	10	16,0	5/8"	M26X1.5	18	27,1	27,0
1200432	H1211110-123000	12	19,0	3/4"	M30X2	22	31,6	32,0
1201372	H1211110-163600	16	25,0	1"	M36X2	28	34,4	36,0
1201373	H1211110-204500	20	32,0	1 1/4"	M45X2	35	40,0	46,0
1201374	H1211110-245200	24	38,0	1 1/2"	M52X2	42	42,0	55,0

// H1221513
Metric Female 24° Cone with O-Ring
ISO 8434-1 - Light Series
DKOL

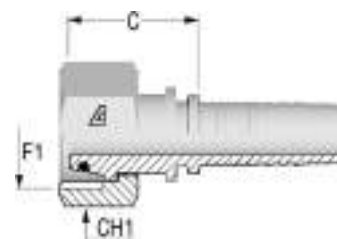

Item Code	Product Code	Nut Type	ID (Dash)	ID (mm)	ID (in)	F1	OD1	C (mm)	CH1 (mm)
1200595	H1221513-031200	Slip on nut	3	5,0	3/16"	M12X1.5	6	23,9	14,0
1202944	H1221511-041200	Crimped	4	6,0	1/4"	M12X1.5	6	24,8	14,0
1200614	H1221513-041400	Slip on nut	4	6,0	1/4"	M14X1.5	8	24,4	17,0
1200609	H1221513-041600	Slip on nut	4	6,0	1/4"	M16X1.5	10	25,4	19,0
1201060	H1221513-041800	Slip on nut	4	6,0	1/4"	M18X1.5	12	25,4	22,0
1238160	H1221512-051400	Thrust wire nut	5	8,0	5/16"	M14X1.5	8	47,7	17,0
1200642	H1221513-051600	Slip on nut	5	8,0	5/16"	M16X1.5	10	25,4	19,0
1200643	H1221513-051800	Slip on nut	5	8,0	5/16"	M18X1.5	12	25,4	22,0
1200667	H1221513-061800	Slip on nut	6	10,0	3/8"	M18X1.5	12	25,4	22,0
1200670	H1221513-062200	Slip on nut	6	10,0	3/8"	M22X1.5	15	27,4	27,0
1246243	H1221511-061600	Crimped	6	10,0	3/8"	M16X1.5	3/8"	23,4	19,0
1238162	H1221512-081800	Thrust wire nut	8	13,0	1/2"	M18X1.5	12	24,0	22,0
1200707	H1221513-082200	Slip on nut	8	13,0	1/2"	M22X1.5	15	28,2	27,0
1201843	H1221513-082600	Slip on nut	8	13,0	1/2"	M26X1.5	18	29,2	32,0
1238163	H1221512-102200	Thrust wire nut	10	16,0	5/8"	M22X1.5	15	25,3	27,0
1200736	H1221513-102600	Slip on nut	10	16,0	5/8"	M26X1.5	18	29,2	32,0
1239646	H1221512-122600	Thrust wire nut	12	19,0	3/4"	M26X1.5	18	25,5	32,0
1200762	H1221513-123000	Slip on nut	12	19,0	3/4"	M30X2	22	31,7	36,0
1220609	H1221513-123600	Slip on nut	12	19,0	3/4"	M36X2	28	32,8	41,0
1201593	H1221512-163000	Thrust wire nut	16	25,0	1"	M30X2	22	44,6	36,0
1201385	H1221513-163600	Slip on nut	16	25,0	1"	M36X2	28	33,6	41,0
1225980	H1221513-164500	Slip on nut	16	25,0	1"	M45X2	35	38,5	50,0
1201386	H1221513-204500	Slip on nut	20	32,0	1 1/4"	M45X2	35	40,1	50,0
1201387	H1221513-245200	Slip on nut	24	38,0	1 1/2"	M52X2	42	40,5	60,0

Image: insert with Slip on Nut.

Design and dimensions shown may be changed without prior notice

// H1221543
45° Metric Female 24° Cone with O-Ring
ISO 8434-1 - Light Series
DKOL 45
Solid one piece

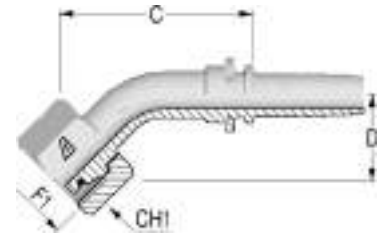

Item Code	Product Code	Nut Type	ID (Dash)	ID (mm)	ID (in)	F1	OD1	C (mm)	D Drop (mm)	CH1 (mm)
1200594	H1221543-031200	Slip on nut	3	5,0	3/16"	M12X1.5	6	44,9	19,0	14,0
1216676	H1221541-041200	Crimped	4	6,0	1/4"	M12X1.5	6	45,2	15,5	14,0
1200612	H1221543-041400	Slip on nut	4	6,0	1/4"	M14X1.5	8	43,0	17,5	17,0
1201576	H1221543-041600	Slip on nut	4	6,0	1/4"	M16X1.5	10	42,0	20,0	19,0
1200645	H1221543-051600	Slip on nut	5	8,0	5/16"	M16X1.5	10	47,5	20,0	19,0
1200646	H1221543-051800	Slip on nut	5	8,0	5/16"	M18X1.5	12	47,0	22,0	22,0
1246245	H1221541-061600	Crimped	6	10,0	3/8"	M16X1.5	10	43,0	19,0	19,0
1200671	H1221543-061800	Slip on nut	6	10,0	3/8"	M18X1.5	12	46,8	19,5	22,0
1239971	H1221542-081800	Thrust wire nut	8	13,0	1/2"	M18X1.5	12	52,0	23,0	22,0
1200711	H1221543-082200	Slip on nut	8	13,0	1/2"	M22X1.5	15	55,0	21,0	27,0
1200738	H1221543-102600	Slip on nut	10	16,0	5/8"	M26X1.5	18	65,3	24,0	32,0
1240723	H1221542-122600	Thrust wire nut	12	19,0	3/4"	M26X1.5	20	77,0	34,0	32,0
1200764	H1221543-123000	Slip on nut	12	19,0	3/4"	M30X2	22	69,4	32,0	36,0
1225983	H1221542-163000	Thrust wire nut	16	25,0	1"	M30X2	22	71,1	29,0	36,0
1201390	H1221543-163600	Slip on nut	16	25,0	1"	M36X2	28	91,4	32,0	41,0
1201392	H1221543-204500	Slip on nut	20	32,0	1 1/4"	M45X2	35	100,0	45,0	50,0
1202128	H1221543-245200	Slip on nut	24	38,0	1 1/2"	M52X2	42	114,1	47,0	60,0

Image: insert with Slip on Nut.

// H1221593
90° Metric Female 24° Cone with O-Ring
ISO 8434-1 - Light Series
DKOL 90
Solid one piece

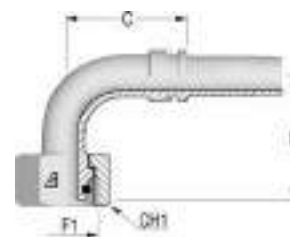

Item Code	Product Code	Nut Type	ID (Dash)	ID (mm)	ID (in)	F1	OD1	C (mm)	D Drop (mm)	CH1 (mm)
1200597	H1221593-031200	Slip on nut	3	5,0	3/16"	M12X1.5	6	23,6	33,0	14,0
1203240	H1221591-041200	Crimped	4	6,0	1/4"	M12X1.5	6	29,5	26,0	14,0
1200618	H1221593-041400	Slip on nut	4	6,0	1/4"	M14X1.5	8	28,3	32,5	17,0
1200616	H1221593-041600	Slip on nut	4	6,0	1/4"	M16X1.5	10	27,0	34,0	19,0
1203218	H1221593-041800	Slip on nut	4	6,0	1/4"	M18X1.5	12	28,8	35,0	22,0
1200648	H1221593-051600	Slip on nut	5	8,0	5/16"	M16X1.5	10	33,7	38,0	19,0
1200649	H1221593-051800	Slip on nut	5	8,0	5/16"	M18X1.5	12	32,2	40,0	22,0
1246244	H1221591-061600	Crimped	6	10,0	3/8"	M16X1.5	10	36,0	36,0	19,0
1200676	H1221593-061800	Slip on nut	6	10,0	3/8"	M18X1.5	12	32,8	39,0	22,0
1200679	H1221593-062200	Slip on nut	6	10,0	3/8"	M22X1.5	15	35,8	38,5	27,0
1238173	H1221592-081800	Thrust wire nut	8	13,0	1/2"	M18X1.5	12	42,0	44,0	22,0
1200713	H1221593-082200	Slip on nut	8	13,0	1/2"	M22X1.5	15	39,8	40,5	27,0
1203154	H1221593-082600	Slip on nut	8	13,0	1/2"	M26X1.5	18	39,8	41,0	32,0
1201292	H1221593-1022B0	Slip on nut	10	16,0	5/8"	M22X1.5	15	51,4	47,0	27,0
1200740	H1221593-102600	Slip on nut	10	16,0	5/8"	M26X1.5	18	51,4	48,0	32,0
1200742	H1221593-103000	Slip on nut	10	16,0	5/8"	M30X2	22	52,4	49,0	36,0
1239736	H1221592-122600	Thrust wire nut	12	19,0	3/4"	M26X1.5	18	60,0	64,0	32,0
1200767	H1221593-123000	Slip on nut	12	19,0	3/4"	M30X2	22	52,1	59,0	36,0
1216685	H1221593-123600	Slip on nut	12	19,0	3/4"	M36X2	28	60,0	63,0	41,0
1225987	H1221592-163000	Thrust wire nut	16	25,0	1"	M30X2	22	66,0	64,0	36,0
1201391	H1221593-163600	Slip on nut	16	25,0	1"	M36X2	28	75,0	68,0	41,0
1216679	H1221592-203600	Thrust wire nut	20	32,0	1 1/4"	M36X2	28	92,2	86,0	41,0
1201393	H1221593-204500	Slip on nut	20	32,0	1 1/4"	M45X2	35	90,5	89,0	50,0
1201394	H1221593-245200	Slip on nut	24	38,0	1 1/2"	M52X2	42	106,5	97,5	60,0

Image: insert with Slip on Nut.

Design and dimensions shown may be changed without prior notice

// H1211210
Metric Male 24° Seat
DIN 3853 - Heavy Series
CES

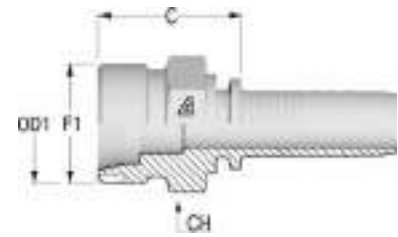

Item Code	Product Code	ID (Dash)	ID (mm)	ID (in)	F1	OD1	C (mm)	CH (mm)
1201828	H1211210-041400	4	6,0	1/4"	M14X1.5	6	24,3	17,0
1200485	H1211210-041600	4	6,0	1/4"	M16X1.5	8	24,3	17,0
1200477	H1211210-041800	4	6,0	1/4"	M18X1.5	10	25,3	19,0
1200521	H1211210-052000	5	8,0	5/16"	M20X1.5	12	25,3	22,0
1200316	H1211210-062000	6	10,0	3/8"	M20X1.5	12	25,3	22,0
1221728	H1211210-062400	6	10,0	3/8"	M24X1.5	16	28,1	24,0
1200319	H1211210-062200	6	10,0	3/8"	M22X1.5	14	27,3	22,0
1202267	H1211210-061800	6	10,0	3/8"	M18X1.5	10	25,3	19,0
1200360	H1211210-082400	8	13,0	1/2"	M24X1.5	16	29,1	24,0
1200364	H1211210-083000	8	13,0	1/2"	M30X2	20	33,1	32,0
1202564	H1211210-082200	8	13,0	1/2"	M22X1.5	14	28,1	22,0
1200403	H1211210-103000	10	16,0	5/8"	M30X2	20	33,1	32,0
1202526	H1211210-123000	12	19,0	3/4"	M30X2	20	33,6	32,0
1200434	H1211210-123600	12	19,0	3/4"	M36X2	25	37,6	36,0
1201375	H1211210-164200	16	25,0	1"	M42X2	30	42,4	46,0
1203151	H1211210-163600	16	25,0	1"	M36X2	25	38,4	36,0
1201376	H1211210-205200	20	32,0	1 1/4"	M52X2	38	48,0	55,0

// H1221613
Metric Female 24° Cone with O-Ring
ISO 8434-1 - Heavy Series
DKOS

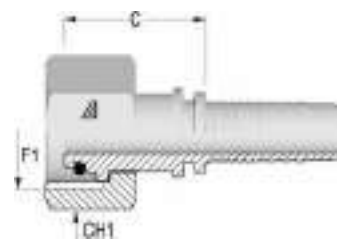

Item Code	Product Code	Nut Type	ID (Dash)	ID (mm)	ID (in)	F1	OD1	C (mm)	CH1 (mm)
1200596	H1221613-031600	Slip on nut	3	5,0	3/16"	M16X1.5	8	27,2	19,0
1201827	H1221613-041400	Slip on nut	4	6,0	1/4"	M14X1.5	6	26,4	17,0
1200615	H1221613-041600	Slip on nut	4	6,0	1/4"	M16X1.5	8	27,7	19,0
1200610	H1221613-041800	Slip on nut	4	6,0	1/4"	M18X1.5	10	27,6	22,0
1201061	H1221613-042000	Slip on nut	4	6,0	1/4"	M20X1.5	12	27,6	24,0
1201832	H1221613-051800	Slip on nut	5	8,0	5/16"	M18X1.5	10	27,6	22,0
1200644	H1221613-052000	Slip on nut	5	8,0	5/16"	M20X1.5	12	27,6	24,0
1239671	H1221612-061600	Thrust wire nut	6	10,0	3/8"	M16X1.5	8	23,2	19,0
1238179	H1221612-061800	Thrust wire nut	6	10,0	3/8"	M18X1.5	10	22,3	22,0
1200668	H1221613-062000	Slip on nut	6	10,0	3/8"	M20X1.5	12	27,6	24,0
1200669	H1221613-062200	Slip on nut	6	10,0	3/8"	M22X1.5	14	31,1	27,0
1202570	H1221613-062400	Slip on nut	6	10,0	3/8"	M24X1.5	16	30,9	30,0
1239650	H1221612-082000	Thrust wire nut	8	13,0	1/2"	M20X1.5	12	23,2	24,0
1218557	H1221613-082200	Slip on nut	8	13,0	1/2"	M22X1.5	14	31,9	27,0
1200708	H1221613-082400	Slip on nut	8	13,0	1/2"	M24X1.5	16	31,7	30,0
1200710	H1221613-083000	Slip on nut	8	13,0	1/2"	M30X2	20	36,5	36,0
1200737	H1221613-103000	Slip on nut	10	16,0	5/8"	M30X2	20	36,5	36,0
1201732	H1221613-123000	Slip on nut	12	19,0	3/4"	M30X2	20	37,0	36,0
1200763	H1221613-123600	Slip on nut	12	19,0	3/4"	M36X2	25	40,2	46,0
1239744	H1221612-163000	Thrust wire nut	16	25,0	1"	M30X2	20	29,8	36,0
1203099	H1221613-163600	Slip on nut	16	25,0	1"	M36X2	25	41,0	46,0
1201388	H1221613-164200	Slip on nut	16	25,0	1"	M42X2	30	43,1	50,0
1216693	H1221613-204200	Slip on nut	20	32,0	1 1/4"	M42X2	30	44,7	50,0
1201389	H1221613-205200	Slip on nut	20	32,0	1 1/4"	M52X2	38	48,1	60,0
1216695	H1221613-245200	Slip on nut	24	38,0	1 1/2"	M52X2	38	48,1	60,0

Image: insert with Slip on Nut.

Design and dimensions shown may be changed without prior notice

// H1221643

45° Metric Female 24° Cone with O-Ring

ISO 8434-1 - Heavy Series

DKOS 45

Solid one piece

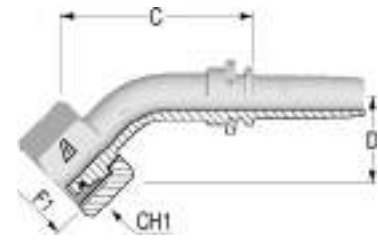

Item Code	Product Code	Nut Type	ID (Dash)	ID (mm)	ID (in)	F1	OD1	C (mm)	D Drop (mm)	CH1 (mm)
1216697	H1221643-041400	Slip on nut	4	6,0	1/4"	M14X1.5	6	47,0	20,0	17,0
1200613	H1221643-041600	Slip on nut	4	6,0	1/4"	M16X1.5	8	48,6	16,0	19,0
1200611	H1221643-041800	Slip on nut	4	6,0	1/4"	M18X1.5	10	43,5	19,0	22,0
1240698	H1221643-051800	Slip on nut	5	8,0	5/16"	M18X1.5	10	46,0	18,0	22,0
1200647	H1221643-052000	Slip on nut	5	8,0	5/16"	M20X1.5	12	48,1	21,0	24,0
1239968	H1221642-061800	Thrust wire nut	6	10,0	3/8"	M18X1.5	10	47,0	21,0	22,0
1200672	H1221643-062000	Slip on nut	6	10,0	3/8"	M20X1.5	12	50,6	20,0	24,0
1200673	H1221643-062200	Slip on nut	6	10,0	3/8"	M22X1.5	14	52,9	21,0	27,0
1242602	H1221642-082000	Thrust wire nut	8	13,0	1/2"	M20X1.5	12	54,0	24,0	24,0
1200712	H1221643-082400	Slip on nut	8	13,0	1/2"	M24X1.5	16	55,8	21,5	30,0
1201300	H1221643-103000	Slip on nut	10	16,0	5/8"	M30X2	20	66,3	30,0	36,0
1202891	H1221643-123000	Slip on nut	12	19,0	3/4"	M30X2	20	66,1	29,0	36,0
1200765	H1221643-123600	Slip on nut	12	19,0	3/4"	M36X2	25	69,5	33,0	46,0
1203098	H1221643-163600	Slip on nut	16	25,0	1"	M36X2	25	89,7	36,0	46,0
1201395	H1221643-164200	Slip on nut	16	25,0	1"	M42X2	30	110,3	40,5	50,0
1201398	H1221643-205200	Slip on nut	20	32,0	1 1/4"	M52X2	38	109,0	45,0	60,0

Image: insert with Slip on Nut.

// H1221693

90° Metric Female 24° Cone with O-Ring

ISO 8434-1 - Heavy Series

DKOS 90

Solid one piece

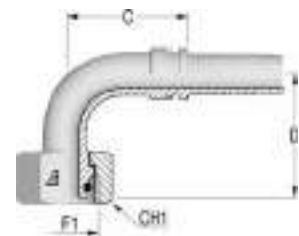

Item Code	Product Code	Nut Type	ID (Dash)	ID (mm)	ID (in)	F1	OD1	C (mm)	D Drop (mm)	CH1 (mm)
1201065	H1221693-041400	Slip on nut	4	6,0	1/4"	M14X1.5	6	27,3	33,0	17,0
1200619	H1221693-041600	Slip on nut	4	6,0	1/4"	M16X1.5	8	27,3	33,0	19,0
1200617	H1221693-041800	Slip on nut	4	6,0	1/4"	M18X1.5	10	26,8	34,0	22,0
1216700	H1221693-051800	Slip on nut	5	8,0	5/16"	M18X1.5	10	33,2	39,0	22,0
1200650	H1221693-052000	Slip on nut	5	8,0	5/16"	M20X1.5	12	33,2	39,0	24,0
1239989	H1221692-061600	Thrust wire nut	6	10,0	3/8"	M16X1.5	8	33,0	38,0	19,0
1239926	H1221692-061800	Thrust wire nut	6	10,0	3/8"	M18X1.5	10	35,0	38,0	22,0
1200677	H1221693-062000	Slip on nut	6	10,0	3/8"	M20X1.5	12	34,3	38,5	24,0
1200678	H1221693-062200	Slip on nut	6	10,0	3/8"	M22X1.5	14	34,3	40,5	27,0
1240110	H1221692-082000	Thrust wire nut	8	13,0	1/2"	M20X1.5	12	40,0	45,0	24,0
1200714	H1221693-082400	Slip on nut	8	13,0	1/2"	M24X1.5	16	39,8	41,5	30,0
1201253	H1221693-083000	Slip on nut	8	13,0	1/2"	M30X2	20	45,8	50,0	36,0
1240088	H1221692-102400	Thrust wire nut	10	16,0	5/8"	M24X1.5	16	52,0	56,0	30,0
1200741	H1221693-103000	Slip on nut	10	16,0	5/8"	M30X2	20	47,9	55,0	36,0
1200766	H1221693-123000	Slip on nut	12	19,0	3/4"	M30X2	20	50,6	58,0	36,0
1200768	H1221693-123600	Slip on nut	12	19,0	3/4"	M36X2	25	50,6	59,5	46,0
1203097	H1221693-163600	Slip on nut	16	25,0	1"	M36X2	25	77,6	73,5	46,0
1201396	H1221693-164200	Slip on nut	16	25,0	1"	M42X2	30	75,6	79,0	50,0
1203096	H1221693-204200	Slip on nut	20	32,0	1 1/4"	M42X2	30	95,0	88,0	50,0
1201397	H1221693-205200	Slip on nut	20	32,0	1 1/4"	M52X2	38	94,0	92,0	60,0

Image: insert with Slip on Nut.

// H1221313
Universal Metric Female

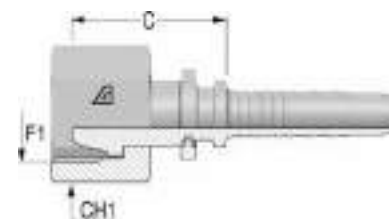

Item Code	Product Code	Nut Type	ID (Dash)	ID (mm)	ID (in)	F1 Dash	F1	C (mm)	CH1 (mm)
1200631	H1221313-041400	Slip on nut	4	6,0	1/4"	14	M14X1.5	22,3	17,0
1200632	H1221313-041600	Slip on nut	4	6,0	1/4"	16	M16X1.5	22,3	19,0
1200633	H1221313-041800	Slip on nut	4	6,0	1/4"	18	M18X1.5	22,3	22,0
1200658	H1221313-051600	Slip on nut	5	8,0	5/16"	16	M16X1.5	22,3	19,0
1200659	H1221313-051800	Slip on nut	5	8,0	5/16"	18	M18X1.5	22,3	22,0
1200698	H1221313-061800	Slip on nut	6	10,0	3/8"	18	M18X1.5	22,3	22,0
1200729	H1221313-082200	Slip on nut	8	13,0	1/2"	22	M22X1.5	24,7	27,0
1200753	H1221313-102600	Slip on nut	10	16,0	5/8"	26	M26X1.5	25,1	32,0

// H1221343
45° Universal Metric Female

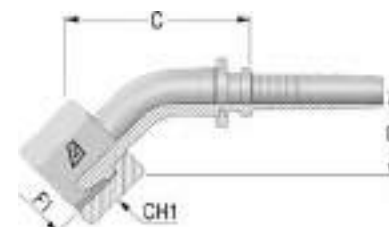

Item Code	Product Code	Nut Type	ID (Dash)	ID (mm)	ID (in)	F1 Dash	F1	C (mm)	D Drop (mm)	CH1 (mm)
1216669	H1221343-041400	Slip on nut	4	6,0	1/4"	14	M14X1.5	36,5	16,0	17,0
1200660	H1221343-051600	Slip on nut	5	8,0	5/16"	16	M16X1.5	42,1	19,0	19,0
1201450	H1221343-061800	Slip on nut	6	10,0	3/8"	18	M18X1.5	42,8	20,0	22,0
1225972	H1221343-082200	Slip on nut	8	13,0	1/2"	22	M22X1.5	54,9	20,0	27,0
1225973	H1221343-102600	Slip on nut	10	16,0	5/8"	26	M26X1.5	54,0	22,0	32,0

// H1221393
90° Universal Metric Female



Item Code	Product Code	Nut Type	ID (Dash)	ID (mm)	ID (in)	F1 Dash	F1	C (mm)	D Drop (mm)	CH1 (mm)
1225975	H1221393-041400	Slip on nut	4	6,0	1/4"	14	M14X1.5	28,4	30,0	17,0
1201452	H1221393-041600	Slip on nut	4	6,0	1/4"	16	M16X1.5	28,3	33,0	19,0
1200661	H1221393-051600	Slip on nut	5	8,0	5/16"	16	M16X1.5	34,2	36,0	19,0
1201323	H1221393-051800	Slip on nut	5	8,0	5/16"	18	M18X1.5	34,0	32,0	22,0
1200701	H1221393-061800	Slip on nut	6	10,0	3/8"	18	M18X1.5	32,8	37,0	22,0
1201580	H1221393-062200	Slip on nut	6	10,0	3/8"	22	M22X1.5	32,3	36,0	27,0
1200730	H1221393-082200	Slip on nut	8	13,0	1/2"	22	M22X1.5	39,8	40,0	27,0
1216672	H1221393-102600	Slip on nut	10	16,0	5/8"	26	M26X1.5	51,0	46,0	32,0

Design and dimensions shown may be changed without prior notice

// H1221013
Metric Female 60° Cone
DIN 3863

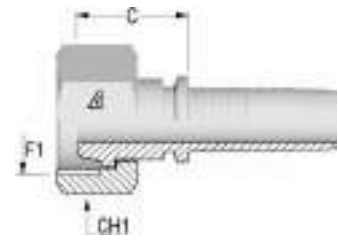

Item Code	Product Code	Nut Type	ID (Dash)	ID (mm)	ID (in)	F1 Dash	F1	C (mm)	CH1 (mm)
1200759	H1221013-123000	Slip on nut	12	19,0	3/4"	30	M30X1.5	21,6	36,0
1201572	H1221013-163800	Slip on nut	16	25,0	1"	38	M38X1.5	28,0	46,0

// H1221093
90° Metric Female 60° Cone
DIN 3863
Solid one piece

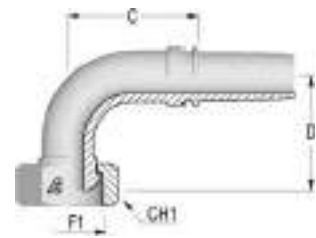

Item Code	Product Code	Nut Type	ID (Dash)	ID (mm)	ID (in)	F1 Dash	F1	C (mm)	D Drop (mm)	CH1 (mm)
1202056	H1221093-123000	Slip on nut	12	19,0	3/4"	30	M30X1.5	54,6	47,0	36,0
1201620	H1221093-163800	Slip on nut	16	25,0	1"	38	M38X1.5	72,6	60,0	46,0

// H1252010
Metric Straight Standpipe
DIN 2353
RSL/RSS

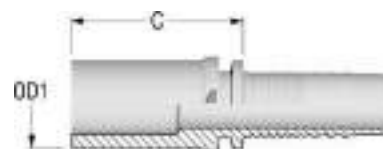

Item Code	Product Code	ID (Dash)	ID (mm)	ID (in)	OD1	C (mm)
1200855	H1252010-030600	3	5,0	3/16"	6	27,8
1200856	H1252010-030800	3	5,0	3/16"	8	29,8
1200865	H1252010-040600	4	6,0	1/4"	6	28,3
1200867	H1252010-040800	4	6,0	1/4"	8	30,2
1200859	H1252010-041000	4	6,0	1/4"	10	32,2
1200860	H1252010-041200	4	6,0	1/4"	12	31,2
1200878	H1252010-050800	5	8,0	5/16"	8	30,3
1200871	H1252010-051000	5	8,0	5/16"	10	30,2
1200872	H1252010-051200	5	8,0	5/16"	12	32,7
1200793	H1252010-061000	6	10,0	3/8"	10	30,3
1200794	H1252010-061200	6	10,0	3/8"	12	29,3
1200796	H1252010-061400	6	10,0	3/8"	14	35,8
1200797	H1252010-061500	6	10,0	3/8"	15	34,8
1216922	H1252010-081000	8	13,0	1/2"	10	32,5
1200809	H1252010-081200	8	13,0	1/2"	12	32,1
1200811	H1252010-081400	8	13,0	1/2"	14	36,1
1200812	H1252010-081500	8	13,0	1/2"	15	32,1
1200813	H1252010-081600	8	13,0	1/2"	16	37,1
1200815	H1252010-081800	8	13,0	1/2"	18	36,0
1200828	H1252010-101800	10	16,0	5/8"	18	34,2
1200829	H1252010-102000	10	16,0	5/8"	20	44,2
1200832	H1252010-102200	10	16,0	5/8"	22	37,2
1200838	H1252010-122000	12	19,0	3/4"	20	45,5
1200840	H1252010-122200	12	19,0	3/4"	22	36,5
1200841	H1252010-122500	12	19,0	3/4"	25	48,5
1201442	H1252010-162500	16	25,0	1"	25	51,4
1201440	H1252010-162800	16	25,0	1"	28	40,4
1201441	H1252010-163000	16	25,0	1"	30	54,4
1214227	H1252010-163800	16	25,0	1"	38	60,4
1214228	H1252010-203000	20	32,0	1 1/4"	30	56,0
1201443	H1252010-203500	20	32,0	1 1/4"	35	48,0
1201444	H1252010-203800	20	32,0	1 1/4"	38	62,0
1203082	H1252010-243800	24	38,0	1 1/2"	38	62,0
1201445	H1252010-244200	24	38,0	1 1/2"	42	52,0

Design and dimensions shown may be changed without prior notice

// H1252040

45° Metric Standpipe

DIN 2353 - RSL45/RSS 45

Solid one piece

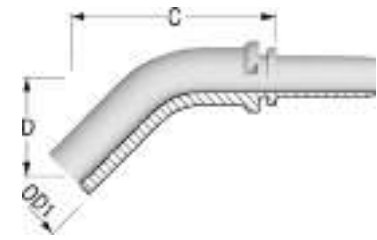

Item Code	Product Code	ID (Dash)	ID (mm)	ID (in)	OD1	C (mm)	D Drop (mm)
1200863	H1252040-040600	4	6,0	1/4"	6	50,1	28,0
1200864	H1252040-040800	4	6,0	1/4"	8	43,2	23,0
1200862	H1252040-041000	4	6,0	1/4"	10	48,0	24,0
1200876	H1252040-051000	5	8,0	5/16"	10	48,4	24,0
1200877	H1252040-051200	5	8,0	5/16"	12	55,4	28,0
1200800	H1252040-061000	6	10,0	3/8"	10	48,5	24,0
1200801	H1252040-061200	6	10,0	3/8"	12	55,5	28,0
1200802	H1252040-061400	6	10,0	3/8"	14	53,1	28,0
1200817	H1252040-081500	8	13,0	1/2"	15	62,6	28,5
1200818	H1252040-081600	8	13,0	1/2"	16	63,3	32,0
1200843	H1252040-122200	12	19,0	3/4"	22	74,3	37,0
1200844	H1252040-122500	12	19,0	3/4"	25	83,0	44,0
1214232	H1252040-163000	16	25,0	1"	30	137,0	46,1

// H1252090

90° Metric Standpipe

DIN 2353 - RSL 90/RSS90

Solid one piece



Item Code	Product Code	ID (Dash)	ID (mm)	ID (in)	OD1	C (mm)	D Drop (mm)
1200857	H1252090-030600	3	5,0	3/16"	6	24,5	36,0
1200869	H1252090-040600	4	6,0	1/4"	6	25,4	36,0
1200870	H1252090-040800	4	6,0	1/4"	8	25,9	44,0
1200868	H1252090-041000	4	6,0	1/4"	10	37,0	42,0
1202296	H1252090-041200	4	6,0	1/4"	12	38,0	50,0
1200879	H1252090-051000	5	8,0	5/16"	10	28,6	48,5
1200880	H1252090-051200	5	8,0	5/16"	12	39,4	55,0
1200803	H1252090-061000	6	10,0	3/8"	10	30,7	42,0
1200804	H1252090-061200	6	10,0	3/8"	12	35,0	50,0
1200805	H1252090-061400	6	10,0	3/8"	14	37,0	50,0
1218454	H1252090-081200	8	13,0	1/2"	12	41,1	52,0
1200822	H1252090-081500	8	13,0	1/2"	15	44,7	57,0
1200823	H1252090-081600	8	13,0	1/2"	16	43,7	64,0
1203079	H1252090-081800	8	13,0	1/2"	18	58,1	59,0
1200835	H1252090-101800	10	16,0	5/8"	18	52,2	58,0
1200836	H1252090-102000	10	16,0	5/8"	20	62,6	70,0
1210832	H1252090-102200	10	16,0	5/8"	22	49,4	64,0
1203081	H1252090-122000	12	19,0	3/4"	20	63,4	70,0
1200846	H1252090-122200	12	19,0	3/4"	22	53,1	67,5
1200847	H1252090-122500	12	19,0	3/4"	25	63,2	85,0
1214233	H1252090-162500	16	25,0	1"	25	73,1	98,5
1202886	H1252090-162800	16	25,0	1"	28	73,1	89,5
1214234	H1252090-163000	16	25,0	1"	30	73,1	102,5
1214235	H1252090-203500	20	32,0	1 1/4"	35	89,0	106,5

// H1230910
Metric Banjo
RNM

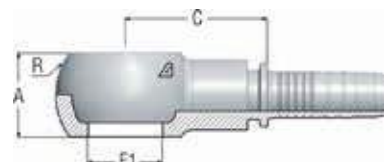

Item Code	Product Code	ID (Dash)	ID (mm)	ID (in)	F1	C (mm)	R (mm)	A (mm)
1202577	H1230910-031000	3	5,0	3/16"	M10X1.0	24,0	17	10
1200470	H1230910-041400	4	6,0	1/4"	M14X1.5	27,5	24	14
1200468	H1230910-041000	4	6,0	1/4"	M10X1.0	25,0	17	10
1200469	H1230910-041200	4	6,0	1/4"	M12X1.5	28,5	20	12
1200516	H1230910-051800	5	8,0	5/16"	M18X1.5	28,5	32	20
1200514	H1230910-051400	5	8,0	5/16"	M14X1.5	27,5	24	14
1200515	H1230910-051600	5	8,0	5/16"	M16X1.5	30,5	28	18
1200513	H1230910-051200	5	8,0	5/16"	M12X1.5	28,5	24	12
1200310	H1230910-061600	6	10,0	3/8"	M16X1.5	30,5	28	18
1200309	H1230910-061400	6	10,0	3/8"	M14X1.5	27,5	24	14
1200311	H1230910-061800	6	10,0	3/8"	M18X1.5	31,5	32	20
1200347	H1230910-082200	8	13,0	1/2"	M22X1.5	35,0	39	22
1200346	H1230910-081800	8	13,0	1/2"	M18X1.5	32,0	32	20
1200389	H1230910-102200	10	16,0	5/8"	M22X1.5	35,0	39	24
1200422	H1230910-122600	12	19,0	3/4"	M26X1.5	38,5	46	29
1203083	H1230910-163000	16	25,0	1"	M30X1.5	42,5	54	36

// H10V0810
Metric Bolt

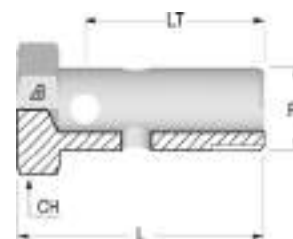

Item Code	Product Code	F1 Dash	F1	LT (mm)	L1 (mm)	CH (mm)
1210374	H10V0810-100000	10	M10X1.0	19	24,0	14,0
1210375	H10V0810-120000	12	M12X1.5	24	29,0	17,0
1210368	H10V0810-140000	14	M14X1.5	28	34,0	19,0
1210384	H10V0810-160000	16	M16X1.5	34	41,0	22,0
1210369	H10V0810-180000	18	M18X1.5	37	44,0	24,0
1210371	H10V0810-220000	22	M22X1.5	41	48,0	27,0
1210406	H10V0810-260000	26	M26X1.5	42	52,0	32,0
1210405	H10V0810-300000	30	M30X1.5	51	62,0	38,0

Design and dimensions shown may be changed without prior notice

// PRESSURE WASHER

// H1224914

Universal Female for Pressure Washer

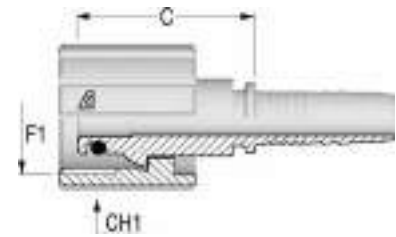

Item Code	Product Code	Nut Type	ID (Dash)	ID (mm)	ID (in)	F1 Dash	F1	C (mm)	CH1 (mm)
1203350	H1224914-042200	Slip on nut	4	6,0	1/4"	22	M22X1.5	36,8	35,0
1203351	H1224914-052200	Slip on nut	5	8,0	5/16"	22	M22X1.5	36,8	35,0
1203352	H1224914-062200	Slip on nut	6	10,0	3/8"	22	M22X1.5	36,8	35,0

// SAE INSERTS

// H1226611

SAE Female Swivel 45° Seat

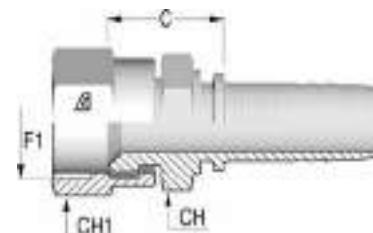

Item Code	Product Code	Nut Type	ID (Dash)	ID (mm)	ID (in)	F1 Dash	F1	C (mm)	CH (mm)	CH1 (mm)
1202661	H1226611-060600	Crimped	6	10,0	3/8"	6	5/8-18	23,3	19,0	22,0
1226098	H1226611-081000	Crimped	8	13,0	1/2"	10	7/8-14	26,6	22,0	27,0
1202371	H1226611-121200	Crimped	12	19,0	3/4"	12	1 1/16-14	28,6	27,0	32,0

// H1213010

SAE Male Solid - O-Ring Boss

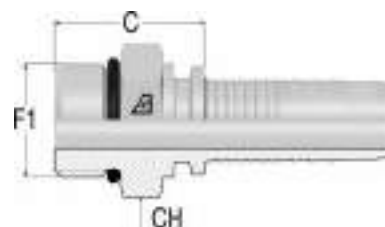

Item Code	Product Code	ID (Dash)	ID (mm)	ID (in)	F1 Dash	F1	C (mm)	CH (mm)
1203147	H1213010-040400	4	6,0	1/4"	4	7/16-20	20,3	14,0
1201833	H1213010-040500	4	6,0	1/4"	5	1/2-20	21,3	16,0
1202519	H1213010-040600	4	6,0	1/4"	6	9/16-18	22,3	17,0
1201834	H1213010-060600	6	10,0	3/8"	6	9/16-18	23,3	19,0
1200337	H1213010-060800	6	10,0	3/8"	8	3/4-16	24,3	22,0
1200338	H1213010-061000	6	10,0	3/8"	10	7/8-14	26,8	27,0
1200382	H1213010-080800	8	13,0	1/2"	8	3/4-16	25,1	22,0
1200383	H1213010-081000	8	13,0	1/2"	10	7/8-14	27,6	27,0
1200381	H1213010-081200	8	13,0	1/2"	12	1 1/16-12	32,1	32,0
1221652	H1213010-101000	10	16,0	5/8"	10	7/8-14	27,6	24,0
1203146	H1213010-121000	12	19,0	3/4"	10	7/8-14	28,1	27,0
1200445	H1213010-121200	12	19,0	3/4"	12	1 1/16-12	32,6	32,0
1201836	H1213010-161600	16	25,0	1"	16	1 5/16-12	35,4	38,0
1225859	H1213010-202000	20	32,0	1 1/4"	20	1 5/8-12	39,0	46,0

Design and dimensions shown may be changed without prior notice

// H1213011

SAE Male Swivel - O-Ring Boss

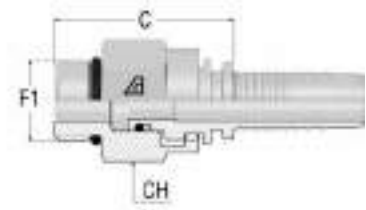

Item Code	Product Code	Nut Type	ID (Dash)	ID (mm)	ID (in)	F1 Dash	F1	C (mm)	CH (mm)
1225927	H1213011-060600	Crimped	6	10,0	3/8"	6	9/16-18	40,5	22,0
1225928	H1213011-060800	Crimped	6	10,0	3/8"	8	3/4-16	22,0	22,0
1225929	H1213011-080800	Crimped	8	13,0	1/2"	8	3/4-16	23,0	25,0
1225930	H1213011-081000	Crimped	8	13,0	1/2"	10	7/8-14	23,0	25,0
1230553	H1213011-121200	Crimped	12	19,0	3/4"	12	1 1/16-12	49,6	32,0

// H1213081

90° Compact SAE Male Swivel - O-Ring Boss

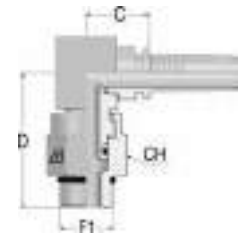

Item Code	Product Code	Nut Type	ID (Dash)	ID (mm)	ID (in)	F1 Dash	F1	C (mm)	D Drop (mm)	CH (mm)
1226490	H1213081-040500	Crimped	4	6,0	1/4"	5	1/2-20	17,0	34,0	17,0
1225933	H1213081-060800	Crimped	6	10,0	3/8"	8	3/4-16	22,0	44,0	25,0
1225934	H1213081-080800	Crimped	8	13,0	1/2"	8	3/4-16	21,6	49,7	25,0
1225935	H1213081-081000	Crimped	8	13,0	1/2"	10	7/8-14	23,0	49,0	25,0
1226492	H1213081-121200	Crimped	12	19,0	3/4"	12	1 1/16-12	27,0	60,0	27,0
1240593	H1213081-161600	Crimped	16	25,0	1"	16	1 5/16-12	34,4	67,5	41,0

// JIC 37° INSERTS

// H1212510

JIC Male 37° Cone

AGJ

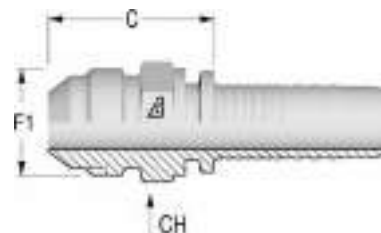

Item Code	Product Code	ID (Dash)	ID (mm)	ID (in)	F1 Dash	F1	C (mm)	CH (mm)
1200457	H1212510-030400	3	5,0	3/16"	4	7/16-20	23,8	12,0
1200500	H1212510-040400	4	6,0	1/4"	4	7/16-20	25,3	12,0
1200499	H1212510-040500	4	6,0	1/4"	5	1/2-20	25,3	14,0
1200501	H1212510-040600	4	6,0	1/4"	6	9/16-18	26,3	17,0
1200534	H1212510-050500	5	8,0	5/16"	5	1/2-20	25,3	14,0
1200535	H1212510-050600	5	8,0	5/16"	6	9/16-18	26,3	17,0
1201087	H1212510-050800	5	8,0	5/16"	8	3/4-16	29,8	19,0
1200332	H1212510-060600	6	10,0	3/8"	6	9/16-18	26,3	17,0
1200330	H1212510-060800	6	10,0	3/8"	8	3/4-16	29,8	19,0
1200331	H1212510-061000	6	10,0	3/8"	10	7/8-14	33,8	24,0
1200375	H1212510-080800	8	13,0	1/2"	8	3/4-16	30,6	19,0
1200376	H1212510-081000	8	13,0	1/2"	10	7/8-14	34,6	24,0
1200374	H1212510-081200	8	13,0	1/2"	12	1 1/16-12	37,1	27,0
1200413	H1212510-101000	10	16,0	5/8"	10	7/8-14	34,6	24,0
1200411	H1212510-101200	10	16,0	5/8"	12	1 1/16-12	37,1	27,0
1200441	H1212510-121200	12	19,0	3/4"	12	1 1/16-12	37,6	27,0
1200442	H1212510-121400	12	19,0	3/4"	14	1 3/16-12	40,1	32,0
1200443	H1212510-121600	12	19,0	3/4"	16	1 5/16-12	42,6	36,0
1222989	H1212510-161200	16	25,0	1"	12	1 1/16-12	40,4	32,0
1201379	H1212510-161600	16	25,0	1"	16	1 5/16-12	43,4	36,0
1201380	H1212510-162000	16	25,0	1"	20	1 5/8-12	46,9	46,0
1201381	H1212510-202000	20	32,0	1 1/4"	20	1 5/8-12	48,5	46,0
1201785	H1212510-202400	20	32,0	1 1/4"	24	1 7/8-12	52,5	50,0
1201382	H1212510-242400	24	38,0	1 1/2"	24	1 7/8-12	52,5	50,0
1201383	H1212510-323200	32	51,0	2"	32	2 1/2-12	62,0	65,0

Design and dimensions shown may be changed without prior notice

// H1222511

JIC Female 37° Seat

DKJ

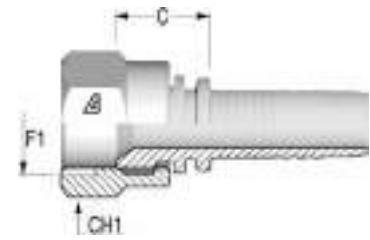

Item Code	Product Code	Nut Type	ID (Dash)	ID (mm)	ID (in)	F1 Dash	F1	C (mm)	CH1 (mm)
1200600	H1222511-030400	Crimped	3	5,0	3/16"	4	7/16-20	14,3	16,0
1200625	H1222511-040400	Crimped	4	6,0	1/4"	4	7/16-20	14,6	16,0
1200623	H1222511-040500	Crimped	4	6,0	1/4"	5	1/2-20	15,3	17,0
1200626	H1222511-040600	Crimped	4	6,0	1/4"	6	9/16-18	15,3	19,0
1200655	H1222511-050500	Crimped	5	8,0	5/16"	5	1/2-20	15,3	17,0
1200656	H1222511-050600	Crimped	5	8,0	5/16"	6	9/16-18	15,3	19,0
1200691	H1222511-060600	Crimped	6	10,0	3/8"	6	9/16-18	15,3	19,0
1200687	H1222511-060800	Crimped	6	10,0	3/8"	8	3/4-16	17,8	25,0
1200690	H1222511-061000	Crimped	6	10,0	3/8"	10	7/8-14	20,3	27,0
1200723	H1222511-080800	Crimped	8	13,0	1/2"	8	3/4-16	18,6	25,0
1200725	H1222511-081000	Crimped	8	13,0	1/2"	10	7/8-14	19,6	27,0
1200722	H1222511-081200	Crimped	8	13,0	1/2"	12	1 1/16-12	22,1	32,0
1200751	H1222511-101000	Crimped	10	16,0	5/8"	10	7/8-14	19,6	27,0
1200749	H1222511-101200	Crimped	10	16,0	5/8"	12	1 1/16-12	20,1	32,0
1201841	H1222511-121000	Crimped	12	19,0	3/4"	10	7/8-14	20,1	27,0
1200774	H1222511-121200	Crimped	12	19,0	3/4"	12	1 1/16-12	20,6	32,0
1200775	H1222511-121400	Crimped	12	19,0	3/4"	14	1 3/16-12	19,9	36,0
1200776	H1222511-121600	Crimped	12	19,0	3/4"	16	1 5/16-12	22,1	38,0
1201399	H1222511-161200	Crimped	16	25,0	1"	12	1 1/16-12	22,4	32,0
1201400	H1222511-161600	Crimped	16	25,0	1"	16	1 5/16-12	23,9	38,0
1201401	H1222512-162000	Thrust wire nut	16	25,0	1"	20	1 5/8-12	26,5	50,0
1202820	H1222511-201600	Crimped	20	32,0	1 1/4"	16	1 5/16-12	26,5	38,0
1201402	H1222512-202000	Thrust wire nut	20	32,0	1 1/4"	20	1 5/8-12	28,1	50,0
1201403	H1222512-202400	Thrust wire nut	20	32,0	1 1/4"	24	1 7/8-12	30,4	55,0
1201097	H1222512-242400	Thrust wire nut	24	38,0	1 1/2"	24	1 7/8-12	29,4	55,0
1201404	H1222512-323200	Thrust wire nut	32	51,0	2"	32	2 1/2-12	32,0	70,0

Image: insert with Crimped Nut.

// H1226511

JIC Female 37° Seat with Stem Hexagon
DKJ

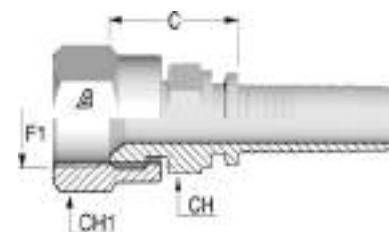

Item Code	Product Code	Nut Type	ID (Dash)	ID (mm)	ID (in)	F1 Dash	F1	C (mm)	CH (mm)	CH1 (mm)
1200599	H1226511-030400	Crimped	3	5,0	3/16"	4	7/16-20	18,1	12,0	16,0
1200621	H1226511-040400	Crimped	4	6,0	1/4"	4	7/16-20	18,3	14,0	16,0
1201264	H1226511-050600	Crimped	5	8,0	5/16"	6	9/16-18	20,3	14,0	19,0
1200622	H1226511-040600	Crimped	4	6,0	1/4"	6	9/16-18	20,3	14,0	19,0
1202406	H1226511-040500	Crimped	4	6,0	1/4"	5	1/2-20	20,3	14,0	17,0
1201497	H1226511-050500	Crimped	5	8,0	5/16"	5	1/2-20	20,3	14,0	17,0
1203246	H1226511-060400	Crimped	6	10,0	3/8"	4	7/16-20	20,6	17,0	16,0
1200686	H1226511-060600	Crimped	6	10,0	3/8"	6	9/16-18	21,3	17,0	19,0
1223146	H1226511-060500	Crimped	6	10,0	3/8"	5	1/2-20	21,3	16,0	17,0
1203090	H1226511-080600	Crimped	8	13,0	1/2"	6	9/16-18	23,1	19,0	19,0
1200685	H1226511-060800	Crimped	6	10,0	3/8"	8	3/4-16	24,8	19,0	25,0
1200720	H1226511-080800	Crimped	8	13,0	1/2"	8	3/4-16	25,6	19,0	25,0
1201340	H1226511-061000	Crimped	6	10,0	3/8"	10	7/8-14	25,8	22,0	27,0
1200721	H1226511-081000	Crimped	8	13,0	1/2"	10	7/8-14	26,6	22,0	27,0
1203329	H1226511-100800	Crimped	10	16,0	5/8"	8	3/4-16	26,6	24,0	25,0
1201728	H1226511-041000	Crimped	10	16,0	5/8"	10	7/8-14	27,6	24,0	27,0
1202895	H1226511-121000	Crimped	12	19,0	3/4"	10	7/8-14	28,1	27,0	27,0
1210833	H1226511-081200	Crimped	8	13,0	1/2"	12	1 1/16-12	28,1	25,0	32,0
1201464	H1226511-101200	Crimped	10	16,0	5/8"	12	1 1/16-12	28,1	25,0	32,0
1201333	H1226511-121200	Crimped	12	19,0	3/4"	12	1 1/16-12	28,6	27,0	32,0
1214219	H1226511-121400	Crimped	12	19,0	3/4"	14	1 3/16-12	29,9	32,0	36,0
1203088	H1226511-161200	Crimped	16	25,0	1"	12	1 1/16-12	31,4	32,0	32,0
1203243	H1226511-141600	Crimped	14	22,0	7/8"	16	1 5/16-12	32,1	32,0	38,0
1203089	H1226511-121600	Crimped	12	19,0	3/4"	16	1 5/16-12	32,1	32,0	38,0
1202408	H1226511-161600	Crimped	16	25,0	1"	16	1 5/16-12	32,9	32,0	38,0
1216812	H1226511-201600	Crimped	20	32,0	1 1/4"	16	1 5/16-12	37,5	41,0	38,0
1214220	H1226512-162000	Thrust wire nut	16	25,0	1"	20	1 5/8-12	37,5	41,0	50,0
1216813	H1226512-182000	Thrust wire nut		28,0	1 1/8"	20	1 5/8-12	37,5	41,0	50,0
1202483	H1226512-202000	Thrust wire nut	20	32,0	1 1/4"	20	1 5/8-12	39,1	41,0	50,0
1226093	H1226512-202400	Thrust wire nut	20	32,0	1 1/4"	24	1 7/8-12	43,4	50,0	55,0
1216814	H1226512-222400	Thrust wire nut		35,0	1 3/8"	24	1 7/8-12	43,4	50,0	55,0
1216815	H1226512-242400	Thrust wire nut	24	38,0	1 1/2"	24	1 7/8-12	43,4	50,0	55,0
1216816	H1226512-323200	Thrust wire nut	32	51,0	2"	32	2 1/2-12	49,0	65,0	70,0

Image: insert with Crimped Nut.

Design and dimensions shown may be changed without prior notice

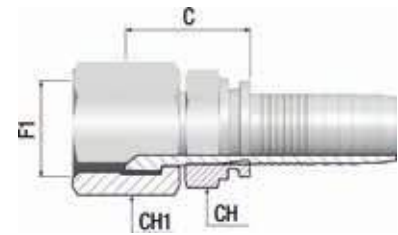
// H1226514 **NEW****JIC Female 37° Seat with double Hexagon
DKJ and solid nut**

Item Code	Product Code	Nut Type	ID (Dash)	ID (mm)	ID (in)	F1 Dash	F1	C (mm)	CH (mm)	CH1 (mm)
1244537	H1226514-040400	Slip on nut	4	6,0	1/4"	4	7/16-20	19,0	14,0	14,0
1245538	H1226514-040500	Slip on nut	4	6,0	1/4"	5	1/2-20	18,9	14,0	17,0
1248014	H122651K-040600	Slip on nut	4	6,0	1/4"	6	9/16-18	22,0	14,0	19,0
1235613	H1226514-050500	Slip on nut	5	8,0	5/16"	5	1/2-20	20,6	14,0	17,0
1245542	H1226514-050600	Slip on nut	5	8,0	5/16"	6	9/16-18	22,1	14,0	19,0
1235614	H1226514-060600	Slip on nut	6	10,0	3/8"	6	9/16-18	22,1	17,0	19,0
1248122	H122651K-060800	Slip on nut	6	10,0	3/8"	8	3/4-16	24,0	17,0	22,0
1238237	H1226514-080800	Slip on nut	8	13,0	1/2"	8	3/4-16	25,7	19,0	22,0
1248016	H122651K-081000	Slip on nut	8	13,0	1/2"	10	7/8-14	29,0	19,0	27,0
1235615	H1226514-101000	Slip on nut	10	16,0	5/8"	10	7/8-14	29,2	24,0	27,0
1248017	H122651K-101200	Slip on nut	10	16,0	5/8"	12	1 1/16-12	28,6	24,0	32,0
1235616	H1226514-121200	Slip on nut	12	19,0	3/4"	12	1 1/16-12	29,7	27,0	32,0
1248018	H122651K-121600	Slip on nut	12	19,0	3/4"	16	1 5/16-12	36,1	32,0	41,0
1235617	H1226514-161600	Slip on nut	16	25,0	1"	16	1 5/16-12	33,9	32,0	41,0

Product Codes roots ending with K: insert with double hexagon knurled (ex. H122651K).

// H1222541-M

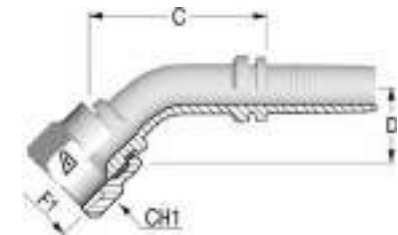
**45° JIC Female 37° Seat
Medium Drop
DKJ 45M
Solid one piece**

Item Code	Product Code	Nut Type	ID (Dash)	ID (mm)	ID (in)	F1 Dash	F1	C (mm)	D Drop (mm)	CH1 (mm)
1202821	H1222541-03040M	Crimped	3	5,0	3/16"	4	7/16-20	37,1	10,0	16,0
1202822	H1222541-04040M	Crimped	4	6,0	1/4"	4	7/16-20	36,6	10,0	16,0
1202823	H1222541-04050M	Crimped	4	6,0	1/4"	5	1/2-20	37,2	12,0	17,0
1202824	H1222541-04060M	Crimped	4	6,0	1/4"	6	9/16-18	39,4	11,0	19,0
1202825	H1222541-05050M	Crimped	5	8,0	5/16"	5	1/2-20	39,8	12,0	17,0
1202826	H1222541-05060M	Crimped	5	8,0	5/16"	6	9/16-18	42,8	12,0	19,0
1202827	H1222541-06060M	Crimped	6	10,0	3/8"	6	9/16-18	46,3	11,0	19,0
1202791	H1222541-06080M	Crimped	6	10,0	3/8"	8	3/4-16	47,2	15,0	25,0
1202828	H1222541-08080M	Crimped	8	13,0	1/2"	8	3/4-16	51,6	15,0	25,0
1202829	H1222541-08100M	Crimped	8	13,0	1/2"	10	7/8-14	50,7	16,0	27,0
1202830	H1222541-08120M	Crimped	8	13,0	1/2"	12	1 1/16-12	57,0	21,0	32,0
1202832	H1222541-10100M	Crimped	10	16,0	5/8"	10	7/8-14	62,2	19,0	27,0
1202831	H1222541-10120M	Crimped	10	16,0	5/8"	12	1 1/16-12	68,6	21,0	32,0
1202833	H1222541-12120M	Crimped	12	19,0	3/4"	12	1 1/16-12	67,5	21,0	32,0
1200778	H1222541-121400	Crimped	12	19,0	3/4"	14	1 3/16-12	67,6	23,0	36,0
1202834	H1222541-12160M	Crimped	12	19,0	3/4"	16	1 5/16-12	71,4	26,0	38,0
1202835	H1222541-16160M	Crimped	16	25,0	1"	16	1 5/16-12	79,4	24,0	38,0
1202836	H1222542-16200M	Thrust wire nut	16	25,0	1"	20	1 5/8-12	83,8	37,0	50,0
1202837	H1222542-20200M	Thrust wire nut	20	32,0	1 1/4"	20	1 5/8-12	97,1	37,0	50,0
1202839	H1222542-24240M	Thrust wire nut	24	38,0	1 1/2"	24	1 7/8-12	112,7	43,0	55,0
1202840	H1222542-32320M	Thrust wire nut	32	51,0	2"	32	2 1/2-12	159,9	67,0	70,0

Image: insert with Crimped Nut.

// H1226544-M NEW

45° JIC Female 37° Seat

Medium Drop

DKJ 45M

Solid nut and double Hexagon crimped

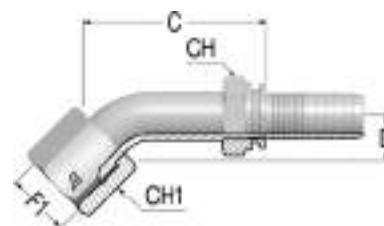

Item Code	Product Code	Nut Type	ID (Dash)	ID (mm)	ID (in)	F1 Dash	F1	C (mm)	D Drop (mm)	CH (mm)	CH1 (mm)
1241580	H1226544-04040M	Slip on nut	4	6,0	1/4"	4	7/16-20	37,0	10,0	14,0	14,0
1243629	H1226544-04060M	Slip on nut	4	6,0	1/4"	6	9/16-18	39,4	11,0	14,0	19,0
1241581	H1226544-05050M	Slip on nut	5	8,0	5/16"	5	1/2-20	40,0	11,0	14,0	17,0
1241582	H1226544-06060M	Slip on nut	6	10,0	3/8"	6	9/16-18	46,0	11,0	17,0	19,0
1244831	H1226544-06080M	Slip on nut	6	10,0	3/8"	8	3/4-16	47,0	22,0	17,0	22,0
1241583	H1226544-08080M	Slip on nut	8	13,0	1/2"	8	3/4-16	52,0	15,0	19,0	22,0
1245511	H1226544-08100M	Slip on nut	8	13,0	1/2"	10	7/8-14	51,0	16,0	19,0	27,0
1241585	H1226544-10100S	Slip on nut	10	16,0	5/8"	10	7/8-14	63,4	16,0	24,0	27,0
1244829	H1226544-10120M	Slip on nut	10	16,0	5/8"	12	1 1/16-12	69,0	21,0	24,0	32,0
1241586	H1226544-12120M	Slip on nut	12	19,0	3/4"	12	1 1/16-12	67,0	21,0	27,0	32,0
1246147	H1226544-12160M	Slip on nut	12	19,0	3/4"	16	1 5/16-12	71,0	24,0	27,0	41,0
1241587	H1226544-16160M	Slip on nut	16	25,0	1"	16	1 5/16-12	80,0	24,0	32,0	41,0

// H1222591-S

90° JIC Female 37° Seat

Short Drop

DKJ 90S

Solid one piece

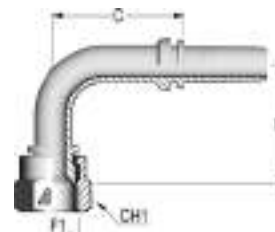

Item Code	Product Code	Nut Type	ID (Dash)	ID (mm)	ID (in)	F1 Dash	F1	C (mm)	D Drop (mm)	CH1 (mm)
1202841	H1222591-03040S	Crimped	3	5,0	3/16"	4	7/16-20	26,7	21,0	16,0
1202772	H1222591-04040S	Crimped	4	6,0	1/4"	4	7/16-20	27,0	21,0	16,0
1203118	H1222591-04050S	Crimped	4	6,0	1/4"	5	1/2-20	26,5	23,5	17,0
1202788	H1222591-04060S	Crimped	4	6,0	1/4"	6	9/16-18	31,0	23,0	19,0
1203116	H1222591-05060S	Crimped	5	8,0	5/16"	6	9/16-18	42,7	23,0	19,0
1216771	H1222591-06050S	Crimped	6	10,0	3/8"	5	1/2-20	33,3	25,0	17,0
1203032	H1222591-06060S	Crimped	6	10,0	3/8"	6	9/16-18	42,3	25,0	19,0
1203033	H1222591-06080S	Crimped	6	10,0	3/8"	8	3/4-16	48,8	29,0	25,0
1203034	H1222591-08080S	Crimped	8	13,0	1/2"	8	3/4-16	46,4	29,0	25,0
1202815	H1222591-08100S	Crimped	8	13,0	1/2"	10	7/8-14	45,8	32,0	27,0
1202744	H1222591-08120S	Crimped	8	13,0	1/2"	12	1 1/16-12	37,3	46,0	32,0
1203035	H1222591-1010BS	Crimped	10	16,0	5/8"	10	7/8-14	36,5	32,0	27,0
1202745	H1222591-10120S	Crimped	10	16,0	5/8"	12	1 1/16-12	47,9	48,0	32,0
1202845	H1222591-12120S	Crimped	12	19,0	3/4"	12	1 1/16-12	58,2	46,0	32,0
1200780	H1222591-12140S	Crimped	12	19,0	3/4"	14	1 3/16-12	49,6	52,5	36,0
1202846	H1222591-12160S	Crimped	12	19,0	3/4"	16	1 5/16-12	53,6	53,0	38,0
1203036	H1222591-16160S	Crimped	16	25,0	1"	16	1 5/16-12	74,0	56,0	38,0

Design and dimensions shown may be changed without prior notice

// H1226594-S **NEW**

90° JIC Female 37° Seat

Short Drop

Solid Nut and double Hexagon crimped

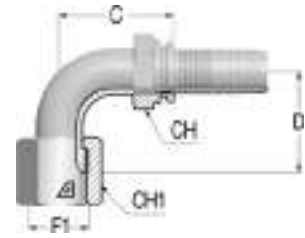

Item Code	Product Code	Nut Type	ID (Dash)	ID (mm)	ID (in)	F1 Dash	F1	C (mm)	D Drop (mm)	CH (mm)	CH1 (mm)
1243637	H1226594-04040S	Slip on nut	4	6,0	1/4"	4	7/16-20	27,0	21,0	14,0	14,0
1245516	H1226594-04050S	Slip on nut	4	6,0	1/4"	5	1/2-20	26,5	21,0	14,0	17,0
1243632	H1226594-04060S	Slip on nut	4	6,0	1/4"	6	9/16-18	30,7	23,0	14,0	19,0
1245523	H1226594-05060S	Slip on nut	5	8,0	5/16"	6	9/16-18	41,0	23,0	14,0	19,0
1243634	H1226594-06060S	Slip on nut	6	10,0	3/8"	6	9/16-18	40,3	24,5	17,0	19,0
1243641	H1226594-06080S	Slip on nut	6	10,0	3/8"	8	3/4-16	48,8	29,0	17,0	22,0
1243644	H1226594-08080S	Slip on nut	8	13,0	1/2"	8	3/4-16	46,0	29,0	19,0	22,0
1245562	H1226594-08100S	Slip on nut	8	13,0	1/2"	10	7/8-14	46,0	32,0	19,0	27,0
1244848	H1226594-10100S	Slip on nut	10	16,0	5/8"	10	7/8-14	42,3	37,0	24,0	27,0
1244849	H1226594-10120S	Slip on nut	10	16,0	5/8"	12	1 1/16-12	48,0	48,0	24,0	32,0
1243635	H1226594-12120S	Slip on nut	12	19,0	3/4"	12	1 1/16-12	62,4	48,0	27,0	32,0
1246115	H1222593-12160S	Slip on nut	12	19,0	3/4"	16	1 5/16-12	53,6	53,0		41,0
1245568	H1226594-16160S	Slip on nut	16	25,0	1"	16	1 5/16-12	74,0	56,0	32,0	41,0

Product Codes roots ending with 3: insert with turned ring (ex. H1222593).

// H1222591-M

90° JIC Female 37° Seat

Medium Drop

DKJ 90M

Solid one piece

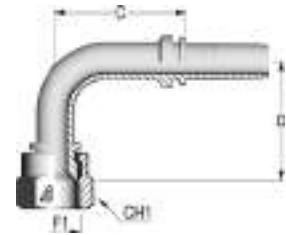

Item Code	Product Code	Nut Type	ID (Dash)	ID (mm)	ID (in)	F1 Dash	F1	C (mm)	D Drop (mm)	CH1 (mm)
1202792	H1222591-03040M	Crimped	3	5,0	3/16"	4	7/16-20	33,5	32,0	16,0
1202739	H1222591-04040M	Crimped	4	6,0	1/4"	4	7/16-20	34,2	32,0	16,0
1202740	H1222591-04050M	Crimped	4	6,0	1/4"	5	1/2-20	25,7	30,0	17,0
1202793	H1222591-04060M	Crimped	4	6,0	1/4"	6	9/16-18	28,5	38,0	19,0
1202794	H1222591-05050M	Crimped	5	8,0	5/16"	5	1/2-20	34,2	32,0	17,0
1202731	H1222591-05060M	Crimped	5	8,0	5/16"	6	9/16-18	33,2	35,0	19,0
1202742	H1222591-06060M	Crimped	6	10,0	3/8"	6	9/16-18	31,3	35,0	19,0
1202732	H1222591-06080M	Crimped	6	10,0	3/8"	8	3/4-16	39,5	41,0	25,0
1200693	H1222591-06100M	Crimped	6	10,0	3/8"	10	7/8-14	44,6	47,0	27,0
1202743	H1222591-08080M	Crimped	8	13,0	1/2"	8	3/4-16	37,2	40,0	25,0
1202741	H1222591-08100M	Crimped	8	13,0	1/2"	10	7/8-14	43,3	47,0	27,0
1202844	H1222591-10100M	Crimped	10	16,0	5/8"	10	7/8-14	49,4	48,0	27,0
1216778	H1222591-10120M	Crimped	10	16,0	5/8"	12	1 1/16-12	47,9	58,0	32,0
1202746	H1222591-12120M	Crimped	12	19,0	3/4"	12	1 1/16-12	52,4	54,0	32,0
1216780	H1222591-12160M	Crimped	12	19,0	3/4"	16	1 5/16-12	52,6	72,0	38,0
1202847	H1222591-16160M	Crimped	16	25,0	1"	16	1 5/16-12	72,6	71,5	38,0
1202848	H1222592-16200M	Thrust wire nut	16	25,0	1"	20	1 5/8-12	72,6	78,0	50,0
1202849	H1222592-20200M	Thrust wire nut	20	32,0	1 1/4"	20	1 5/8-12	82,4	78,0	50,0
1202850	H1222592-20240M	Thrust wire nut	20	32,0	1 1/4"	24	1 7/8-12	87,3	82,0	55,0
1202851	H1222592-24240M	Thrust wire nut	24	38,0	1 1/2"	24	1 7/8-12	95,3	92,0	55,0
1202852	H1222592-32320M	Thrust wire nut	32	51,0	2"	32	2 1/2-12	129,5	140,0	70,0

Image: insert with Crimped Nut.

// H1226594-M NEW

90° JIC Female 37° Seat

Medium Drop

Solid Nut and double Hexagon crimped

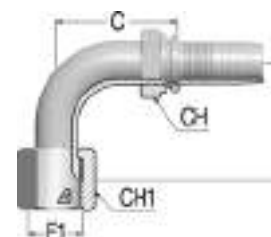

Item Code	Product Code	Nut Type	ID (Dash)	ID (mm)	ID (in)	F1 Dash	F1	C (mm)	D Drop (mm)	CH (mm)	CH1 (mm)
1241588	H1226594-04040M	Slip on nut	4	6,0	1/4"	4	7/16-20	34,0	32,0	14,0	14,0
1245515	H1226594-04050M	Slip on nut	4	6,0	1/4"	5	1/2-20	26,0	32,0	14,0	17,0
1235584	H1222593-04060M	Slip on nut	4	6,0	1/4"	6	9/16-18	31,0	38,0		19,0
1241589	H1226594-05050M	Slip on nut	5	8,0	5/16"	5	1/2-20	34,0	32,0	14,0	17,0
1245522	H1226594-05060M	Slip on nut	5	8,0	5/16"	6	9/16-18	33,0	35,0	14,0	19,0
1241590	H1226594-06060M	Slip on nut	6	10,0	3/8"	6	9/16-18	31,3	38,0	17,0	19,0
1245576	H1222593-06080M	Slip on nut	6	10,0	3/8"	8	3/4-16	41,0	39,5		22,0
1241591	H1226594-08080M	Slip on nut	8	13,0	1/2"	8	3/4-16	37,2	41,0	19,0	22,0
1245560	H1226594-08100M	Slip on nut	8	13,0	1/2"	10	7/8-14	43,3	47,0	19,0	27,0
1241592	H1226594-10100M	Slip on nut	10	16,0	5/8"	10	7/8-14	49,4	47,0	24,0	27,0
1245565	H1226594-10120M	Slip on nut	10	16,0	5/8"	12	1 1/16-12	48,0	58,0	24,0	32,0
1241593	H1226594-12120M	Slip on nut	12	19,0	3/4"	12	1 1/16-12	52,0	58,0	27,0	32,0
1246116	H1222593-12160M	Slip on nut	12	19,0	3/4"	16	1 5/16-12	52,6	71,0		41,0
1241594	H1226594-16160M	Slip on nut	16	25,0	1"	16	1 5/16-12	73,0	71,0	32,0	41,0

Product Codes roots ending with 3: insert with turned ring (ex. H1222593).

// H1222591-L

90° JIC Female 37° Seat

Long Drop

DKJ 90L

Solid one piece

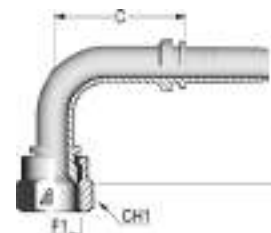

Item Code	Product Code	Nut Type	ID (Dash)	ID (mm)	ID (in)	F1 Dash	F1	C (mm)	D Drop (mm)	CH1 (mm)
1203131	H1222591-04040L	Crimped	4	6,0	1/4"	4	7/16-20	30,8	46,0	16,0
1214215	H1222591-04050L	Crimped	4	6,0	1/4"	5	1/2-20	31,3	45,0	17,0
1203115	H1222591-06060L	Crimped	6	10,0	3/8"	6	9/16-18	43,3	54,0	19,0
1202842	H1222591-06080L	Crimped	6	10,0	3/8"	8	3/4-16	46,8	64,0	25,0
1214216	H1222591-08080L	Crimped	8	13,0	1/2"	8	3/4-16	49,9	64,0	25,0
1202843	H1222591-08100L	Crimped	8	13,0	1/2"	10	7/8-14	37,3	65,0	27,0
1203114	H1222591-10100L	Crimped	10	16,0	5/8"	10	7/8-14	49,9	65,0	27,0
1203112	H1222591-12120L	Crimped	12	19,0	3/4"	12	1 1/16-12	54,1	95,0	32,0
1203111	H1222591-16160L	Crimped	16	25,0	1"	16	1 5/16-12	78,6	114,0	38,0

Design and dimensions shown may be changed without prior notice

// H1226594-L **NEW**

90° JIC Female 37° Seat

Long Drop

Solid Nut and double Hexagon crimped

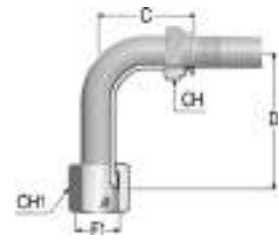

Item Code	Product Code	Nut Type	ID (Dash)	ID (mm)	ID (in)	F1 Dash	F1	C (mm)	D Drop (mm)	CH (mm)	CH1 (mm)
1244851	H1226594-04040L	Slip on nut	4	6,0	1/4"	4	7/16-20	31,0	46,0	14,0	14,0
1245514	H1226594-04050L	Slip on nut	4	6,0	1/4"	5	1/2-20	31,0	46,0	14,0	17,0
1244845	H1226594-06060L	Slip on nut	6	10,0	3/8"	6	9/16-18	43,3	54,0	17,0	17,0
1245766	H1222593-06080L	Slip on nut	6	10,0	3/8"	8	3/4-16	47,0	64,0		22,0
1245557	H1226594-08080L	Slip on nut	8	13,0	1/2"	8	3/4-16	49,9	64,0	19,0	22,0
1244846	H1226594-08100L	Slip on nut	8	13,0	1/2"	10	7/8-14	37,2	65,0	19,0	27,0
1244847	H1226594-10100L	Slip on nut	10	16,0	5/8"	10	7/8-14	50,0	70,0	24,0	27,0
1244850	H1226594-12120L	Slip on nut	12	19,0	3/4"	12	1 1/16-12	54,0	96,0	27,0	32,0
1245567	H1226594-16160L	Slip on nut	16	25,0	1"	16	1 5/16-12	79,0	114,0	32,0	41,0

Product Codes roots ending with 3: insert with turned ring (ex. H1222593).

// NPTF INSERTS

// H1212810

**NPTF Male 60° Seat
AGN**

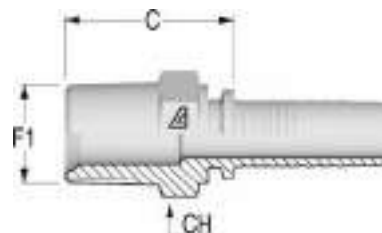

Item Code	Product Code	ID (Dash)	ID (mm)	ID (in)	F1 Dash	F1	C (mm)	CH (mm)
1200448	H1212810-030200	3	5,0	3/16"	2	1/8-27	20,8	12,0
1200466	H1212810-040200	4	6,0	1/4"	2	1/8-27	21,3	14,0
1228235	H121281P-040400	4	6,0	1/4"	4	1/4-18	26,8	14,3
1200511	H1212810-050400	5	8,0	5/16"	4	1/4-18	26,8	17,0
1200307	H1212810-060400	6	10,0	3/8"	4	1/4-18	26,8	17,0
1200512	H1212810-050600	5	8,0	5/16"	6	3/8-18	27,8	19,0
1200467	H1212810-040600	4	6,0	1/4"	6	3/8-18	27,8	19,0
1200308	H1212810-060600	6	10,0	3/8"	6	3/8-18	27,8	19,0
1200345	H1212810-080600	8	13,0	1/2"	6	3/8-18	28,6	19,0
1203150	H1212810-040800	4	6,0	1/4"	8	1/2-14	31,3	22,0
1200306	H1212810-060800	6	10,0	3/8"	8	1/2-14	31,3	22,0
1200343	H1212810-080800	8	13,0	1/2"	8	1/2-14	32,1	22,0
1200387	H1212810-100800	10	16,0	5/8"	8	1/2-14	33,1	24,0
1203149	H1212810-120800	12	19,0	3/4"	8	1/2-14	33,6	27,0
1200344	H1212810-081200	8	13,0	1/2"	12	3/4-14	34,1	27,0
1200388	H1212810-101200	10	16,0	5/8"	12	3/4-14	34,1	27,0
1200421	H1212810-121200	12	19,0	3/4"	12	3/4-14	34,6	27,0
1202282	H1212810-161200	16	25,0	1"	12	3/4-14	39,4	36,0
1200420	H1212810-121600	12	19,0	3/4"	16	1-11 1/2	43,6	36,0
1216610	H1212810-141600	14	22,0	7/8"	16	1-11 1/2	43,6	36,0
1201366	H1212810-161600	16	25,0	1"	16	1-11 1/2	44,4	36,0
1201367	H1212810-162000	16	25,0	1"	20	1 1/4-11 1/2	47,4	46,0
1216611	H1212810-182000		29,0	1 1/8"	20	1 1/4-11 1/2	47,4	46,0
1201368	H1212810-202000	20	32,0	1 1/4"	20	1 1/4-11 1/2	49,0	46,0
1216612	H1212810-222400		35,0	1 3/8"	24	1 1/2-11 1/2	50,5	50,0
1201369	H1212810-242400	24	38,0	1 1/2"	24	1 1/2-11 1/2	50,5	50,0
1201370	H1212810-323200	32	51,0	2"	32	2-11 1/2	54,2	65,0
1216613	H1212810-293200	29	46,0	1 13/16"	32	2-11 1/2	54,2	65,0

// H1222810

NPTF Female Solid

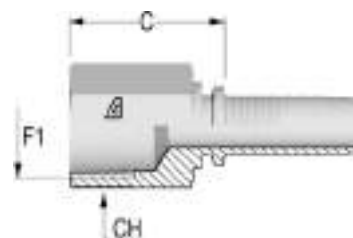

Item Code	Product Code	ID (Dash)	ID (mm)	ID (in)	F1 Dash	F1	C (mm)	CH (mm)
1216794	H1222810-040200	4	6,0	1/4"	2	1/8-27	22,3	14,0
1200464	H1222810-040400	4	6,0	1/4"	4	1/4-18	27,8	19,0
1219145	H1222810-060600	6	10,0	3/8"	6	3/8-18	28,8	22,0
1216795	H1222810-080800	8	13,0	1/2"	8	1/2-14	35,6	25,0
1216796	H1222810-121200	12	19,0	3/4"	12	3/4-14	38,1	32,0
1216797	H1222810-161600	16	25,0	1"	16	1-11 1/2	44,9	38,0

Design and dimensions shown may be changed without prior notice

// H1212811

NPTF Male Swivel 60° Seat

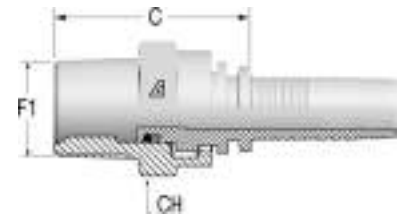

Item Code	Product Code	Nut Type	ID (Dash)	ID (mm)	ID (in)	F1 Dash	F1	C (mm)	CH (mm)
1216614	H1212811-040400	Crimped	4	6,0	1/4"	4	1/4-18	37,6	17,0
1216615	H1212811-040600	Crimped	4	6,0	1/4"	6	3/8-18	39,5	22,0
1216616	H1212811-060400	Crimped	6	10,0	3/8"	4	1/4-18	39,6	17,0
1214186	H1212811-060600	Crimped	6	10,0	3/8"	6	3/8-18	37,5	22,0
1216617	H1212811-060800	Crimped	6	10,0	3/8"	8	1/2-14	43,5	25,0
1216619	H1212811-080600	Crimped	8	13,0	1/2"	6	3/8-18	38,3	22,0
1214187	H1212811-080800	Crimped	8	13,0	1/2"	8	1/2-14	42,3	25,0
1216620	H1212811-121200	Crimped	12	19,0	3/4"	12	3/4-14	50,1	32,0
1216621	H1212811-161600	Crimped	16	25,0	1"	16	1-11/2	57,9	41,0

// H1212881

90° Compact NPTF Male Swivel 60° Seat

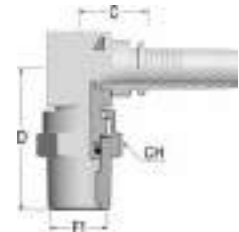

Item Code	Product Code	Nut Type	ID (Dash)	ID (mm)	ID (in)	F1 Dash	F1	C (mm)	D Drop (mm)	CH (mm)
1225918	H1212881-040400	Crimped	4	6,0	1/4"	4	1/4-18	17,0	39,0	17,0
1225920	H1212881-060600	Crimped	6	10,0	3/8"	6	3/8-18	20,8	45,7	19,0
1225921	H1212881-080800	Crimped	8	13,0	1/2"	8	1/2-14	21,6	49,7	19,0
1225922	H1212881-121200	Crimped	12	19,0	3/4"	12	3/4-14	27,0	60,5	27,0

// NPSM INSERTS

// H1227311

NPSM Female

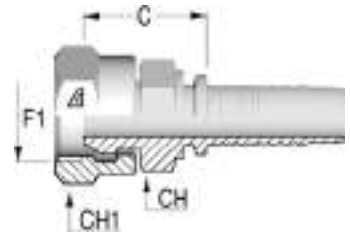

Item Code	Product Code	Nut Type	ID (Dash)	ID (mm)	ID (in)	F1 Dash	F1	C (mm)	CH (mm)	CH1 (mm)
1203280	H1227311-040400	Crimped	4	6,0	1/4"	4	1/4-18	24,3	17,0	19,0
1216834	H1227311-060600	Crimped	6	10,0	3/8"	6	3/8-18	24,8	19,0	22,0
1202084	H1227311-080800	Crimped	8	13,0	1/2"	8	1/2-14	26,6	22,0	27,0
1216835	H1227311-12120Z	Crimped	12	19,0	3/4"	12	3/4-14	20,6		32,0
1216836	H1227311-161600	Crimped	16	25,0	1"	16	1-11 1/2	35,4	36,0	38,0

1216835: without Stem Hexagon, with O-Ring

Design and dimensions shown may be changed without prior notice

// ORFS INSERTS

// H1212410

ORFS Male

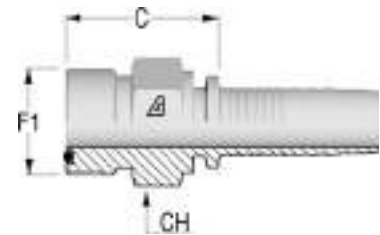

Item Code	Product Code	ID (Dash)	ID (mm)	ID (in)	F1 Dash	F1	C (mm)	CH (mm)
1202488	H1212410-040400	4	6,0	1/4"	4	9/16-18	22,3	17,0
1202489	H1212410-040600	4	6,0	1/4"	6	11/16-16	24,3	19,0
1214185	H1212410-050600	5	8,0	5/16"	6	11/16-16	24,3	19,0
1202490	H1212410-060600	6	10,0	3/8"	6	11/16-16	24,3	19,0
1202491	H1212410-060800	6	10,0	3/8"	8	13/16-16	26,3	22,0
1202055	H1212410-061000	6	10,0	3/8"	10	1-14	29,8	27,0
1202492	H1212410-080800	8	13,0	1/2"	8	13/16-16	27,1	22,0
1202054	H1212410-081000	8	13,0	1/2"	10	1-14	30,6	27,0
1202493	H1212410-081200	8	13,0	1/2"	12	1 3/16-12	34,1	32,0
1202892	H1212410-101000	10	16,0	5/8"	10	1-14	30,6	27,0
1202494	H1212410-101200	10	16,0	5/8"	12	1 3/16-12	34,1	32,0
1202495	H1212410-121000	12	19,0	3/4"	10	1-14	31,1	27,0
1202496	H1212410-121200	12	19,0	3/4"	12	1 3/16-12	34,6	32,0
1202497	H1212410-121600	12	19,0	3/4"	16	1 7/16-12	38,1	41,0
1202498	H1212410-161600	16	25,0	1"	16	1 7/16-12	37,9	38,0
1202499	H1212410-162000	16	25,0	1"	20	1 11/16-12	39,9	46,0
1202500	H1212410-202000	20	32,0	1 1/4"	20	1 11/16-12	41,5	46,0

// H1222411

ORFS Female with Stem Hexagon

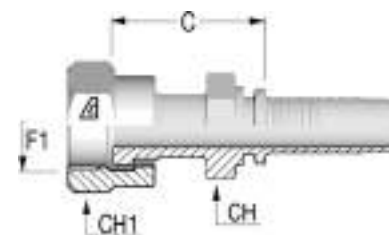

Item Code	Product Code	Nut Type	ID (Dash)	ID (mm)	ID (in)	F1 Dash	F1	C (mm)	CH (mm)	CH1 (mm)
1203220	H1222411-030400	Crimped	3	5,0	3/16"	4	9/16-18	26,8	14,0	17,0
1201586	H1222411-040400	Crimped	4	6,0	1/4"	4	9/16-18	27,3	14,0	17,0
1201855	H1222411-040600	Crimped	4	6,0	1/4"	6	11/16-16	30,3	17,0	22,0
1203143	H1222411-040800	Crimped	4	6,0	1/4"	8	13/16-16	35,3	22,0	24,0
1201741	H1222411-050600	Crimped	5	8,0	5/16"	6	11/16-16	30,3	17,0	22,0
1203237	H1222411-060400	Crimped	6	10,0	3/8"	4	9/16-18	28,3	17,0	17,0
1202369	H1222411-060600	Crimped	6	10,0	3/8"	6	11/16-16	30,3	17,0	22,0
1201339	H1222411-060800	Crimped	6	10,0	3/8"	8	13/16-16	35,3	22,0	24,0
1202563	H1222411-080600	Crimped	8	13,0	1/2"	6	11/16-16	32,1	19,0	22,0
1201338	H1222411-080800	Crimped	8	13,0	1/2"	8	13/16-16	36,1	22,0	24,0
1202052	H1222411-081000	Crimped	8	13,0	1/2"	10	1-14	39,6	24,0	30,0
1203053	H1222411-081200	Crimped	8	13,0	1/2"	12	1 3/16-12	42,1	30,0	36,0
1203061	H1222411-100800	Crimped	10	16,0	5/8"	8	13/16-16	37,1	24,0	24,0
1202612	H1222411-101000	Crimped	10	16,0	5/8"	10	1-14	39,6	24,0	30,0
1201815	H1222411-101200	Crimped	10	16,0	5/8"	12	1 3/16-12	42,1	30,0	36,0
1201782	H1222411-121000	Crimped	12	19,0	3/4"	10	1-14	40,1	27,0	30,0
1202560	H1222411-121200	Crimped	12	19,0	3/4"	12	1 3/16-12	42,6	30,0	36,0
1202053	H1222411-121600	Crimped	12	19,0	3/4"	16	1 7/16-12	48,6	36,0	41,0
1203142	H1222411-161200	Crimped	16	25,0	1"	12	1 3/16-12	45,4	32,0	36,0
1201446	H1222411-161600	Crimped	16	25,0	1"	16	1 7/16-12	49,4	36,0	41,0
1203056	H1222411-162000	Crimped	16	25,0	1"	20	1 11/16-12	50,4	41,0	50,0
1201447	H1222411-202000	Crimped	20	32,0	1 1/4"	20	1 11/16-12	52,0	41,0	50,0
1226017	H1222411-202400	Crimped	20	32,0	1 1/4"	24	2-12	56,5	50,0	60,0
1202046	H1222411-242400	Crimped	24	38,0	1 1/2"	24	2-12	56,5	50,0	60,0

// H1222414 NEW

ORFS Female with support Hexagon knurled

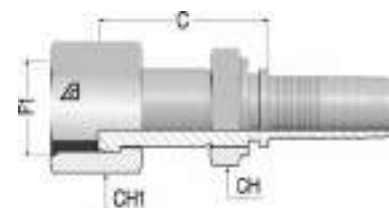

Item Code	Product Code	Nut Type	ID (Dash)	ID (mm)	ID (in)	F1 Dash	F1	C (mm)	CH (mm)	CH1 (mm)
1240013	H1222414-040400	Slip on nut	4	6,0	1/4"	4	9/16-18	29,5	14,0	17,0
1245728	H1222414-040600	Slip on nut	4	6,0	1/4"	6	11/16-16	31,8	17,0	22,0
1245899	H1222414-040800	Slip on nut	4	6,0	1/4"	8	13/16-16	35,8	22,0	24,0
1245428	H1222414-050600	Slip on nut	5	8,0	5/16"	6	11/16-16	30,8	17,0	22,0
1240034	H1222414-060600	Slip on nut	6	10,0	3/8"	6	11/16-16	32,3	17,0	22,0
1245892	H1222414-060800	Slip on nut	6	10,0	3/8"	8	13/16-16	39,3	22,0	24,0
1240035	H1222414-080800	Slip on nut	8	13,0	1/2"	8	13/16-16	40,5	22,0	24,0
1245429	H1222414-081000	Slip on nut	8	13,0	1/2"	10	1-14	43,0	24,0	30,0
1245904	H1222414-081200	Slip on nut	8	13,0	1/2"	12	1 3/16-12	42,1	30,0	36,0
1240036	H1222414-101000	Slip on nut	10	16,0	5/8"	10	1-14	39,6	27,0	30,0
1245905	H1222414-101200	Slip on nut	10	16,0	5/8"	12	1 3/16-12	42,1	30,0	36,0
1240038	H1222414-121200	Slip on nut	12	19,0	3/4"	12	1 3/16-12	42,6	30,0	36,0
1245906	H1222414-121600	Slip on nut	12	19,0	3/4"	16	1 7/16-12	50,6	36,0	41,0
1242623	H1222414-161600	Slip on nut	16	25,0	1"	16	1 7/16-12	51,4	36,0	41,0

Design and dimensions shown may be changed without prior notice

// H1222443-S
45° ORFS Female
Short Drop
DK ORFS 45M
Solid one piece

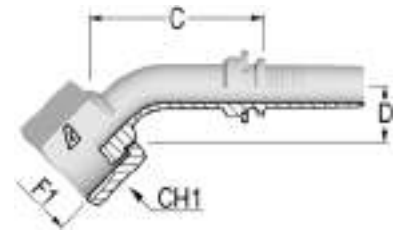

Item Code	Product Code	Nut Type	ID (Dash)	ID (mm)	ID (in)	F1 Dash	F1	C (mm)	D Drop (mm)	CH1 (mm)
1202774	H1222443-04040S	Slip on nut	4	6,0	1/4"	4	9/16-18	41,1	11,0	17,0
1202775	H1222443-04060S	Slip on nut	4	6,0	1/4"	6	11/16-16	46,1	11,0	22,0
1202871	H1222443-05060S	Slip on nut	5	8,0	5/16"	6	11/16-16	46,3	12,0	22,0
1202776	H1222443-06060S	Slip on nut	6	10,0	3/8"	6	11/16-16	47,4	12,0	22,0
1202777	H1222443-06080S	Slip on nut	6	10,0	3/8"	8	13/16-16	51,2	15,0	24,0
1202854	H1222441-08080S	Crimped	8	13,0	1/2"	8	13/16-16	47,1	16,0	24,0
1202771	H1222443-08100S	Slip on nut	8	13,0	1/2"	10	1-14	50,4	16,5	30,0
1202819	H1222443-10100S	Slip on nut	10	16,0	5/8"	10	1-14	57,7	17,0	30,0
1202853	H1222443-10120S	Slip on nut	10	16,0	5/8"	12	1 3/16-12	63,1	21,0	36,0
1202872	H1222443-12120S	Slip on nut	12	19,0	3/4"	12	1 3/16-12	63,5	21,0	36,0
1202915	H1222443-12160S	Slip on nut	12	19,0	3/4"	16	1 7/16-12	70,7	24,0	41,0
1202797	H1222443-16160S	Slip on nut	16	25,0	1"	16	1 7/16-12	82,4	26,0	41,0
1203141	H1222443-16200S	Slip on nut	16	25,0	1"	20	1 11/16-12	85,4	26,0	50,0
1203140	H1222443-20240S	Slip on nut	20	32,0	1 1/4"	24	2-12	101,1	28,0	60,0
1202874	H1222443-24240S	Slip on nut	24	38,0	1 1/2"	24	2-12	104,0	30,5	60,0

Image: insert with Slip on Nut.

// H1222493-S
90° ORFS Female
Short Drop
DK ORFS 90S
Solid one piece

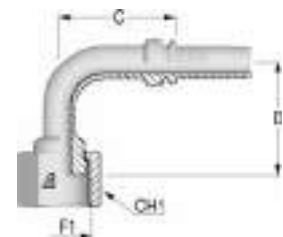

Item Code	Product Code	Nut Type	ID (Dash)	ID (mm)	ID (in)	F1 Dash	F1	C (mm)	D Drop (mm)	CH1 (mm)
1202778	H1222493-04040S	Slip on nut	4	6,0	1/4"	4	9/16-18	28,5	21,0	17,0
1202856	H1222493-04060S	Slip on nut	4	6,0	1/4"	6	11/16-16	32,0	23,0	22,0
1202857	H1222493-05060S	Slip on nut	5	8,0	5/16"	6	11/16-16	50,1	23,5	22,0
1202858	H1222493-06060S	Slip on nut	6	10,0	3/8"	6	11/16-16	40,0	27,0	22,0
1202859	H1222493-06080S	Slip on nut	6	10,0	3/8"	8	13/16-16	41,8	29,0	24,0
1203392	H1222491-08060S	Crimped	8	13,0	1/2"	6	11/16-16	44,1	25,0	22,0
1202855	H1222491-08080S	Crimped	8	13,0	1/2"	8	13/16-16	39,8	29,0	24,0
1203054	H1222493-08100S	Slip on nut	8	13,0	1/2"	10	1-14	46,3	32,5	30,0
1203334	H1222493-08120S	Slip on nut	8	13,0	1/2"	12	1 3/16-12	56,3	51,0	36,0
1202860	H1222493-10100S	Slip on nut	10	16,0	5/8"	10	1-14	52,3	32,5	30,0
1202861	H1222493-10120S	Slip on nut	10	16,0	5/8"	12	1 3/16-12	55,4	49,0	36,0
1202862	H1222493-12120S	Slip on nut	12	19,0	3/4"	12	1 3/16-12	60,6	51,0	36,0
1203055	H1222493-12160S	Slip on nut	12	19,0	3/4"	16	1 7/16-12	61,6	56,0	41,0
1203209	H1222491-16120S	Crimped	16	25,0	1"	12	1 3/16-12	54,6	51,0	36,0
1202863	H1222493-16160S	Slip on nut	16	25,0	1"	16	1 7/16-12	80,0	58,0	41,0
1203135	H1222493-16200S	Slip on nut	16	25,0	1"	20	1 11/16-12	82,6	64,0	50,0
1203133	H1222493-20200S	Slip on nut	20	32,0	1 1/4"	20	1 11/16-12	95,0	68,0	50,0
1214213	H1222493-24240S	Slip on nut	24	38,0	1 1/2"	24	2-12	103,7	78,0	60,0

Image: insert with Slip on Nut.

// H1222493-M
90° ORFS Female
Medium Drop
DK ORFS 90M
Solid one piece



Item Code	Product Code	Nut Type	ID (Dash)	ID (mm)	ID (in)	F1 Dash	F1	C (mm)	D Drop (mm)	CH1 (mm)
1202875	H1222493-04040M	Slip on nut	4	6,0	1/4"	4	9/16-18	29,8	32,0	17,0
1202715	H1222493-04060M	Slip on nut	4	6,0	1/4"	6	11/16-16	37,3	38,0	22,0
1202779	H1222493-05060M	Slip on nut	5	8,0	5/16"	6	11/16-16	40,7	34,0	22,0
1202780	H1222493-06060M	Slip on nut	6	10,0	3/8"	6	11/16-16	41,8	38,0	22,0
1202716	H1222493-06080M	Slip on nut	6	10,0	3/8"	8	13/16-16	43,8	41,0	24,0
1202781	H1222491-08080M	Crimped	8	13,0	1/2"	8	13/16-16	34,8	42,0	24,0
1202770	H1222493-08100M	Slip on nut	8	13,0	1/2"	10	1-14	48,3	47,0	30,0
1202782	H1222493-10100M	Slip on nut	10	16,0	5/8"	10	1-14	55,4	44,0	30,0
1203137	H1222493-10120M	Slip on nut	10	16,0	5/8"	12	1 3/16-12	55,4	58,0	36,0
1202783	H1222493-12120M	Slip on nut	12	19,0	3/4"	12	1 3/16-12	61,6	58,0	36,0
1202916	H1222493-12160M	Slip on nut	12	19,0	3/4"	16	1 7/16-12	65,6	71,0	41,0
1216748	H1222491-16120M	Crimped	16	25,0	1"	12	1 3/16-12	62,6	58,0	36,0
1202717	H1222493-16160M	Slip on nut	16	25,0	1"	16	1 7/16-12	82,6	66,0	41,0
1203069	H1222493-16200M	Slip on nut	16	25,0	1"	20	1 11/16-12	82,6	78,0	50,0
1202876	H1222493-20200M	Slip on nut	20	32,0	1 1/4"	20	1 11/16-12	97,0	78,0	50,0
1202877	H1222493-24240M	Slip on nut	24	38,0	1 1/2"	24	2-12	107,8	87,0	60,0

Image: insert with Slip on Nut.

// H1222493-L
90° ORFS Female
Long Drop
DK ORFS 90L
Solid one piece



Item Code	Product Code	Nut Type	ID (Dash)	ID (mm)	ID (in)	F1 Dash	F1	C (mm)	D Drop (mm)	CH1 (mm)
1210841	H1222493-04040L	Slip on nut	4	6,0	1/4"	4	9/16-18	32,8	46,0	17,0
1203139	H1222493-04060L	Slip on nut	4	6,0	1/4"	6	11/16-16	34,8	54,0	22,0
1203138	H1222493-06060L	Slip on nut	6	10,0	3/8"	6	11/16-16	41,8	54,0	22,0
1203057	H1222493-06080L	Slip on nut	6	10,0	3/8"	8	13/16-16	46,8	64,0	24,0
1202922	H1222491-08080L	Crimped	8	13,0	1/2"	8	13/16-16	38,3	64,0	24,0
1214208	H1222493-08100L	Slip on nut	8	13,0	1/2"	10	1-14	46,3	70,0	30,0
1202918	H1222493-10100L	Slip on nut	10	16,0	5/8"	10	1-14	55,4	70,0	30,0
1202919	H1222493-10120L	Slip on nut	10	16,0	5/8"	12	1 3/16-12	55,4	96,0	36,0
1202920	H1222493-12120L	Slip on nut	12	19,0	3/4"	12	1 3/16-12	61,6	96,0	36,0
1202921	H1222493-12160L	Slip on nut	12	19,0	3/4"	16	1 7/16-12	61,6	118,0	41,0
1203136	H1222493-16160L	Slip on nut	16	25,0	1"	16	1 7/16-12	82,6	114,0	41,0
1203134	H1222493-20200L	Slip on nut	20	32,0	1 1/4"	20	1 11/16-12	97,0	129,0	50,0
1214212	H1222493-24240L	Slip on nut	24	38,0	1 1/2"	24	2-12	110,8	141,0	60,0

Image: insert with Slip on Nut.

Design and dimensions shown may be changed without prior notice

// FRENCH INSERTS

// H1211810

Metric Male - French Type

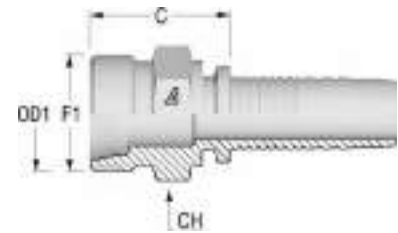

Item Code	Product Code	ID (Dash)	ID (mm)	ID (in)	F1	OD1	C (mm)	CH (mm)
1200522	H1211810-052000	5	8,0	5/16"	M20X1.5		25,3	22,0
1200317	H1211810-062000	6	10,0	3/8"	M20X1.5	13,25	25,3	22,0
1200361	H1211810-082400	8	13,0	1/2"	M24X1.5	16,75	27,1	24,0
1200404	H1211810-103000	10	16,0	5/8"	M30X1.5	21,25	31,1	30,0
1200435	H1211810-123600	12	19,0	3/4"	M36X1.5	26,75	33,6	36,0

// H1221813

Metric Female - French Type

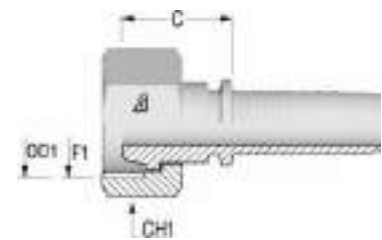

Item Code	Product Code	Nut Type	ID (Dash)	ID (mm)	ID (in)	F1	OD1	C (mm)	CH1 (mm)
1200651	H1221813-052000	Slip on nut	5	8,0	5/16"	M20X1.5		27,6	24,0
1200681	H1221813-062000	Slip on nut	6	10,0	3/8"	M20X1.5		27,6	24,0
1200717	H1221813-082400	Slip on nut	8	13,0	1/2"	M24X1.5		31,7	30,0
1200744	H1221813-103000	Slip on nut	10	16,0	5/8"	M30X1.5	22	26,6	36,0
1200770	H1221813-123600	Slip on nut	12	19,0	3/4"	M36X1.5	28	27,0	42,0

// H1221893

90° Metric Female - French Type

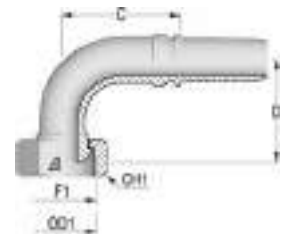

Item Code	Product Code	Nut Type	ID (Dash)	ID (mm)	ID (in)	F1	OD1	C (mm)	D Drop (mm)	CH1 (mm)
1200654	H1221893-052000	Slip on nut	5	8,0	5/16"	M20X1.5	14	32,5	36,5	24,0
1200683	H1221893-062000	Slip on nut	6	10,0	3/8"	M20X1.5		37,0	44,0	24,0
1200719	H1221893-082400	Slip on nut	8	13,0	1/2"	M24X1.5	16	39,5	46,0	30,0
1203156	H1221893-103000	Slip on nut	10	16,0	5/8"	M30X1.5	22	43,0	49,0	36,0
1200773	H1221893-123600	Slip on nut	12	19,0	3/4"	M36X1.5	28	46,6	48,5	42,0

// JIS INSERTS

// H1223711

JIS Female 60° Cone - B 8363 (Type C)

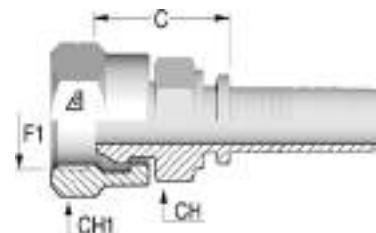

Item Code	Product Code	Nut Type	ID (Dash)	ID (mm)	ID (in)	F1 Dash	F1	C (mm)	CH (mm)	CH1 (mm)
1203110	H1223711-040400	Crimped	4	6,0	1/4"	4	1/4-19	24,3	17,0	19,0
1203109	H1223711-060600	Crimped	6	10,0	3/8"	6	3/8-19	25,5	19,0	22,0
1203108	H1223711-080800	Crimped	8	13,0	1/2"	8	1/2-14	26,1	22,0	27,0
1226069	H1223711-100800	Crimped	10	16,0	5/8"	8	1/2-14	27,1	24,0	27,0
1226549	H1223711-101200	Crimped	10	16,0	5/8"	12	3/4-14	29,6	30,0	36,0
1203107	H1223711-121200	Crimped	12	19,0	3/4"	12	3/4-14	30,1	30,0	36,0
1214218	H1223711-161600	Crimped	16	25,0	1"	16	1-11	34,9	36,0	41,0

// H1223741

45° JIS Female 60° Cone - B 8363 (Type C)

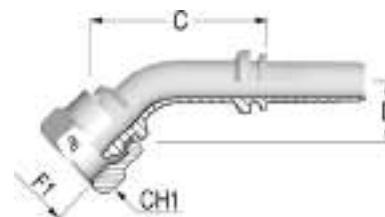

Item Code	Product Code	Nut Type	ID (Dash)	ID (mm)	ID (in)	F1 Dash	F1	C (mm)	D Drop (mm)	CH1 (mm)
1216798	H1223741-040400	Crimped	4	6,0	1/4"	4	1/4-19	24,3	19,0	19,0
1216799	H1223741-060600	Crimped	6	10,0	3/8"	6	3/8-19	26,5	21,0	22,0
1216800	H1223741-080800	Crimped	8	13,0	1/2"	8	1/2-14	27,0	22,0	27,0
1216801	H1223741-121200	Crimped	12	19,0	3/4"	12	3/4-14	19,9	25,0	36,0

// H1223791

90° JIS Female 60° Cone - B 8363 (Type C)

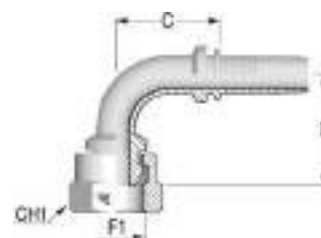

Item Code	Product Code	Nut Type	ID (Dash)	ID (mm)	ID (in)	F1 Dash	F1	C (mm)	D Drop (mm)	CH1 (mm)
1216803	H1223791-040400	Crimped	4	6,0	1/4"	4	1/4-19	25,3	33,0	19,0
1216805	H1223791-060600	Crimped	6	10,0	3/8"	6	3/8-19	32,3	36,5	22,0
1216806	H1223791-080800	Crimped	8	13,0	1/2"	8	1/2-14	37,3	38,5	27,0

Design and dimensions shown may be changed without prior notice

// H122381Z

JIS Female 60° Seat Flare - B 8363 (Type F)

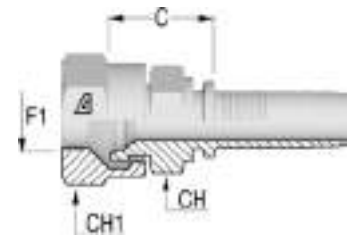

Item Code	Product Code	Nut Type	ID (Dash)	ID (mm)	ID (in)	F1 Dash	F1	C (mm)	CH (mm)	CH1 (mm)
1202947	H122381Z-040400	Crimped	4	6,0	1/4"	4	1/4-19	20,8	17,0	19,0
1202879	H122381Z-060600	Crimped	6	10,0	3/8"	6	3/8-19	21,8	19,0	22,0
1202878	H122381Z-080800	Crimped	8	13,0	1/2"	8	1/2-14	23,6	22,0	27,0
1203106	H122381Z-121200	Crimped	12	19,0	3/4"	12	3/4-14	27,1	30,0	36,0
1203105	H122381Z-161600	Crimped	16	25,0	1"	16	1-11	32,9	36,0	41,0
1201585	H122381Z-202000	Thrust wire nut	20	32,0	1 1/4"	20	1 1/4-11	39,5	46,0	50,0
1201677	H122381Z-242400	Thrust wire nut	24	38,0	1 1/2"	24	1 1/2-11	41,5	50,0	55,0

Image: insert with Crimped Nut.

// H122384Z

45° JIS Female 60° Seat Flare - B 8363 (Type F)

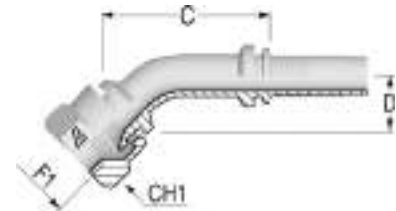

Item Code	Product Code	Nut Type	ID (Dash)	ID (mm)	ID (in)	F1 Dash	F1	C (mm)	D Drop (mm)	CH1 (mm)
1203104	H122384Z-040400	Crimped	4	6,0	1/4"	4	1/4-19	42,5	15,0	19,0

// H122389Z

90° JIS Female 60° Seat Flare - B 8363 (Type F)



Item Code	Product Code	Nut Type	ID (Dash)	ID (mm)	ID (in)	F1 Dash	F1	C (mm)	D Drop (mm)	CH1 (mm)
1203095	H122389Z-040400	Crimped	4	6,0	1/4"	4	1/4-19	27,3	29,5	19,0
1203094	H122389Z-060600	Crimped	6	10,0	3/8"	6	3/8-19	31,3	33,0	22,0
1203093	H122389Z-080800	Crimped	8	13,0	1/2"	8	1/2-14	37,3	36,5	27,0
1203092	H122389Z-121200	Crimped	12	19,0	3/4"	12	3/4-14	46,1	52,0	36,0
1203091	H122389Z-161600	Crimped	16	25,0	1"	16	1-11	77,1	64,5	41,0

// KOMATSU INSERTS

// H1224011

Komatsu Female

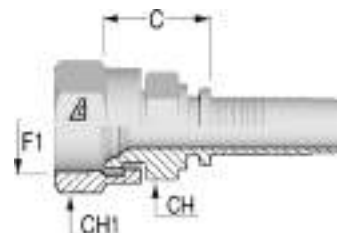

Item Code	Product Code	Nut Type	ID (Dash)	ID (mm)	ID (in)	F1 Dash	F1	C (mm)	CH (mm)	CH1 (mm)
1200502	H1224011-041400	Crimped	4	6,0	1/4"	14	M14X1.5	20,8	17,0	19,0
1216808	H1224011-061400	Crimped	6	10,0	3/8"	14	M14X1.5	20,8	17,0	19,0
1200334	H1224011-061800	Crimped	6	10,0	3/8"	18	M18X1.5	21,8	19,0	22,0
1202688	H1224011-082200	Crimped	8	13,0	1/2"	22	M22X1.5	23,6	22,0	27,0
1200414	H1224011-102400	Crimped	10	16,0	5/8"	24	M24X1.5	27,1	30,0	32,0
1200444	H1224011-123000	Crimped	12	19,0	3/4"	30	M30X1.5	27,6	30,0	36,0
1201720	H1224011-163300	Crimped	16	25,0	1"	33	M33X1.5	35,7	36,0	41,0

// H1244110

Komatsu Flange

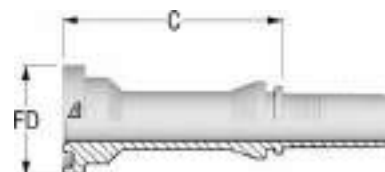

Item Code	Product Code	ID (Dash)	ID (mm)	ID (in)	F1 Dash	F1	FD (mm)	C (mm)
1201625	H1244110-101000	10	16,0	5/8"	10	5/8	34,0	46,7

// H1244140

45° Komatsu Flange

Solid one piece

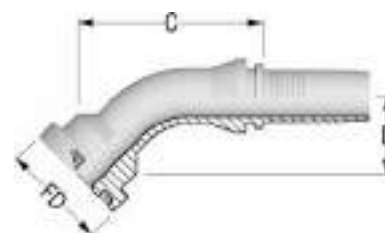

Item Code	Product Code	ID (Dash)	ID (mm)	ID (in)	F1 Dash	F1	FD (mm)	C (mm)	D Drop (mm)
1202066	H1244140-101000	10	16,0	5/8"	10	5/8	34,0	49,1	25,0

Design and dimensions shown may be changed without prior notice

// H1244190
90° Komatsu Flange
Solid one piece



Item Code	Product Code	ID (Dash)	ID (mm)	ID (in)	F1 Dash	F1	FD (mm)	C (mm)	D Drop (mm)
1202067	H1244190-101000	10	16,0	5/8"	10	5/8	34,0	51,0	51,0

// SAE FLANGES

// H1243310

Flange SAE 3000 psi J518 Code 61
SFL

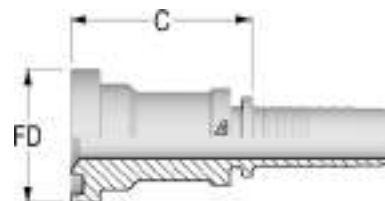

Item Code	Product Code	ID (Dash)	ID (mm)	ID (in)	F1 Dash	F1	FD (mm)	C (mm)	WP (psi)
1202747	H1243310-080800	8	13,0	1/2"	8	1/2	30,2	41,0	5000
1202763	H1243310-081200	8	13,0	1/2"	12	3/4	38,1	42,0	5000
1202801	H1243310-101200	10	16,0	5/8"	12	3/4	38,1	42,2	5000
1201734	H1243310-121200	12	19,0	3/4"	12	3/4	38,1	42,5	5000
1202750	H1243310-121600	12	19,0	3/4"	16	1	44,5	50,5	5000
1201408	H1243310-161600	16	25,0	1"	16	1	44,5	51,4	5000
1201409	H1243310-162000	16	25,0	1"	20	1 1/4	50,8	53,9	4000
1221654	H1243310-201600	20	32,0	1 1/4"	16	1	44,5	53,0	5000
1201410	H1243310-202000	20	32,0	1 1/4"	20	1 1/4	50,8	55,5	4000
1201411	H1243310-202400	20	32,0	1 1/4"	24	1 1/2	60,3	58,5	3000
1201412	H1243310-242400	24	38,0	1 1/2"	24	1 1/2	60,3	58,5	3000
1201413	H1243310-243200	24	38,0	1 1/2"	32	2	71,4	70,0	3000
1221662	H1243310-322400	32	51,0	2"	24	1 1/2	60,3	66,0	3000
1201414	H1243310-323200	32	51,0	2"	32	2	71,4	70,0	3000
1202074	H1243310-324000	32	51,0	2"	40	2 1/2	84,1	83,0	2500
1226113	H1243310-403200	40	63,0	2 1/2"	32	2	71,4	86,5	3000
1203063	H1243310-404000	40	63,0	2 1/2"	40	2 1/2	84,1	86,5	2500

// H1243320

22° Flange SAE 3000 psi J518 Code 61
SFL 22
Solid one piece

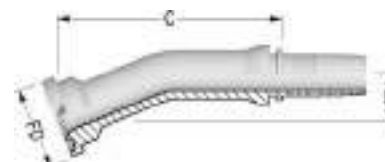

Item Code	Product Code	ID (Dash)	ID (mm)	ID (in)	F1 Dash	F1	FD (mm)	C (mm)	D Drop (mm)	WP (psi)
1216854	H1243320-161600	16	25,0	1"	16	1	44,5	92,7	12,0	5000
1216856	H1243320-202000	20	32,0	1 1/4"	20	1 1/4	50,8	113,6	16,0	4000
1216857	H1243320-202400	20	32,0	1 1/4"	24	1 1/2	60,3	114,7	20,5	3000
1216858	H1243320-242400	24	38,0	1 1/2"	24	1 1/2	60,3	131,0	22,0	3000
1216859	H1243320-323200	32	51,0	2"	32	2	71,4	153,0	22,0	3000

Design and dimensions shown may be changed without prior notice

// H1243330

30° Flange SAE 3000 psi J518 Code 61

SFL 30

Solid one piece

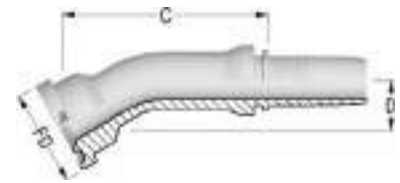

Item Code	Product Code	ID (Dash)	ID (mm)	ID (in)	F1 Dash	F1	FD (mm)	C (mm)	D Drop (mm)	WP (psi)
1216861	H1243330-121200	12	19,0	3/4"	12	3/4	38,1	80,8	12,0	5000
1216862	H1243330-121600	12	19,0	3/4"	16	1	44,5	83,8	12,0	5000
1216863	H1243330-161600	16	25,0	1"	16	1	44,5	89,8	12,0	5000
1216864	H1243330-162000	16	25,0	1"	20	1 1/4	50,8	90,0	12,0	4000
1216866	H1243330-202000	20	32,0	1 1/4"	20	1 1/4	50,8	102,4	12,0	4000
1216867	H1243330-202400	20	32,0	1 1/4"	24	1 1/2	60,3	111,9	13,0	3000
1216868	H1243330-242400	24	38,0	1 1/2"	24	1 1/2	60,3	128,6	23,0	3000
1216869	H1243330-243200	24	38,0	1 1/2"	32	2	71,4	147,0	29,5	3000

// H1243340

45° Flange SAE 3000 psi J518 Code 61

SFL 45

Solid one piece

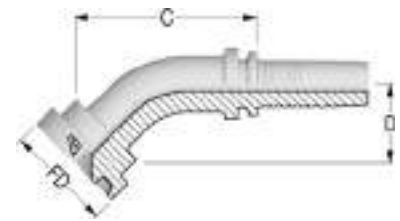

Item Code	Product Code	ID (Dash)	ID (mm)	ID (in)	F1 Dash	F1	FD (mm)	C (mm)	D Drop (mm)	WP (psi)
1202748	H1243340-080800	8	13,0	1/2"	8	1/2	30,2	69,4	22,0	5000
1202751	H1243340-081200	8	13,0	1/2"	12	3/4	38,1	60,3	26,0	5000
1202678	H1243340-121200	12	19,0	3/4"	12	3/4	38,1	73,7	32,0	5000
1202752	H1243340-121600	12	19,0	3/4"	16	1	44,5	77,9	29,0	5000
1214223	H1243340-122000	12	19,0	3/4"	20	1 1/4	50,8	81,5	30,0	5000
1202681	H1243340-161600	16	25,0	1"	16	1	44,5	82,7	33,5	5000
1201845	H1243340-162000	16	25,0	1"	20	1 1/4	50,8	82,2	36,0	4000
1216872	H1243340-201600	20	32,0	1 1/4"	16	1	44,5	114,6	35,1	5000
1201848	H1243340-202000	20	32,0	1 1/4"	20	1 1/4	50,8	95,1	37,5	4000
1202677	H1243340-202400	20	32,0	1 1/4"	24	1 1/2	60,3	104,1	40,0	3000
1216873	H1243340-242000	24	38,0	1 1/2"	20	1 1/4	50,8	144,9	49,5	4000
1202753	H1243340-242400	24	38,0	1 1/2"	24	1 1/2	60,3	116,7	48,0	3000
1202754	H1243340-243200	24	38,0	1 1/2"	32	2	71,4	135,6	55,5	3000
1201982	H1243340-323200	32	51,0	2"	32	2	71,4	140,8	47,5	3000
1216874	H1243340-4040SL	40	63,0	2 1/2"	40	2 1/2	84,1	139,0	53,0	2500

// H1243360

60° Flange SAE 3000 psi J518 Code 61

SFL 60

Solid one piece

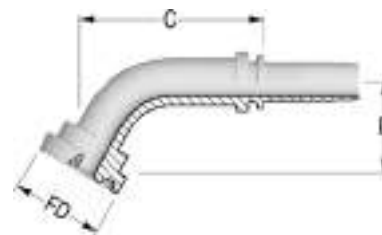

Item Code	Product Code	ID (Dash)	ID (mm)	ID (in)	F1 Dash	F1	FD (mm)	C (mm)	D Drop (mm)	WP (psi)
1216878	H1243360-121200	12	19,0	3/4"	12	3/4	38,1	85,7	37,0	5000
1216880	H1243360-161600	16	25,0	1"	16	1	44,5	101,0	47,0	5000
1216881	H1243360-162000	16	25,0	1"	20	1 1/4	50,8	106,6	43,5	4000
1216882	H1243360-202000	20	32,0	1 1/4"	20	1 1/4	50,8	129,5	56,5	4000
1202882	H1243360-242400	24	38,0	1 1/2"	24	1 1/2	60,3	151,5	57,0	3000
1216884	H1243360-323200	32	51,0	2"	32	2	71,4	173,0	92,0	3000

// H1243390

90° Flange SAE 3000 psi J518 Code 61

SFL 90

Solid one piece

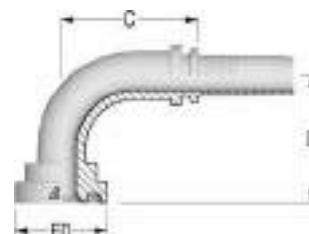

Item Code	Product Code	ID (Dash)	ID (mm)	ID (in)	F1 Dash	F1	FD (mm)	C (mm)	D Drop (mm)	WP (psi)
1202749	H1243390-080800	8	13,0	1/2"	8	1/2	30,2	45,8	42,0	5000
1202755	H1243390-081200	8	13,0	1/2"	12	3/4	38,1	45,3	51,0	5000
1202805	H1243390-101200	10	16,0	5/8"	12	3/4	38,1	49,4	51,0	5000
1202679	H1243390-121200	12	19,0	3/4"	12	3/4	38,1	59,7	58,0	5000
1202756	H1243390-121600	12	19,0	3/4"	16	1	44,5	66,2	64,5	5000
1202883	H1243390-122000	12	19,0	3/4"	20	1 1/4	50,8	69,7	60,0	4000
1202680	H1243390-161600	16	25,0	1"	16	1	44,5	70,6	67,0	5000
1201846	H1243390-162000	16	25,0	1"	20	1 1/4	50,8	73,6	71,0	4000
1216894	H1243390-162400	16	25,0	1"	24	1 1/2	60,3	93,1	75,0	3000
1202884	H1243390-201600	20	32,0	1 1/4"	16	1	44,5	94,4	65,0	5000
1201847	H1243390-202000	20	32,0	1 1/4"	20	1 1/4	50,8	88,0	84,0	4000
1202676	H1243390-202400	20	32,0	1 1/4"	24	1 1/2	60,3	91,5	87,5	3000
1202806	H1243390-242000	24	38,0	1 1/2"	20	1 1/4	50,8	93,6	93,0	4000
1202757	H1243390-242400	24	38,0	1 1/2"	24	1 1/2	60,3	104,8	91,0	3000
1202758	H1243390-243200	24	38,0	1 1/2"	32	2	71,4	104,8	115,0	3000
1216898	H1243390-322400	32	51,0	2"	24	1 1/2	60,3	132,8	133,0	3000
1201983	H1243390-323200	32	51,0	2"	32	2	71,4	129,3	130,0	3000
1203169	H1243390-3240B0	32	51,0	2"	40	2 1/2	84,1	103,0	100,0	2500
1203364	H1243390-4040SL	40	63,0	2 1/2"	40	2 1/2	84,1	137,2	125,0	2500

Design and dimensions shown may be changed without prior notice

// H1243610

Flange SAE 6000 psi J518 Code 62

SFS

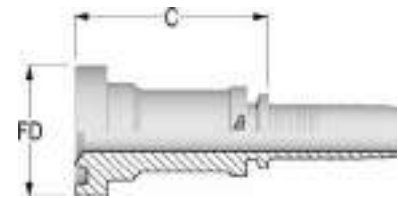

Item Code	Product Code	ID (Dash)	ID (mm)	ID (in)	F1 Dash	F1	FD (mm)	C (mm)	WP (psi)
1202511	H1243610-080800	8	13,0	1/2"	8	1/2	31,8	47,0	6000
1202759	H1243610-081200	8	13,0	1/2"	12	3/4	41,3	52,0	6000
1202807	H1243610-101200	10	16,0	5/8"	12	3/4	41,3	52,2	6000
1202733	H1243610-121200	12	19,0	3/4"	12	3/4	41,3	52,5	6000
1202760	H1243610-121600	12	19,0	3/4"	16	1	47,6	55,5	6000
1216908	H1243610-161200	16	25,0	1"	12	3/4	41,3	56,4	6000
1201415	H1243610-161600	16	25,0	1"	16	1	47,6	56,4	6000
1201416	H1243610-162000	16	25,0	1"	20	1 1/4	54,0	63,4	6000
1201417	H1243610-202000	20	32,0	1 1/4"	20	1 1/4	54,0	83,0	6000
1201418	H1243610-202400	20	32,0	1 1/4"	24	1 1/2	63,5	71,0	6000
1201419	H1243610-242400	24	38,0	1 1/2"	24	1 1/2	63,5	101,0	6000
1201420	H1243610-243200	24	38,0	1 1/2"	32	2	79,4	76,0	6000
1201421	H1243610-323200	32	51,0	2"	32	2	79,4	76,0	6000

// H1243640

45° Flange SAE 6000 psi J518 Code 62

SFS 45

Solid one piece



Item Code	Product Code	ID (Dash)	ID (mm)	ID (in)	F1 Dash	F1	FD (mm)	C (mm)	D Drop (mm)	WP (psi)
1201729	H1243640-080800	8	13,0	1/2"	8	1/2	31,8	56,5	23,0	6000
1202764	H1243640-081200	8	13,0	1/2"	12	3/4	41,3	79,9	30,5	6000
1216910	H1243640-101200	10	16,0	5/8"	12	3/4	41,3	69,0	31,0	6000
1202082	H1243640-121200	12	19,0	3/4"	12	3/4	41,3	84,1	31,0	6000
1202083	H1243640-121600	12	19,0	3/4"	16	1	47,6	80,0	33,5	6000
1201794	H1243640-161600	16	25,0	1"	16	1	47,6	96,7	36,0	6000
1202091	H1243640-162000	16	25,0	1"	20	1 1/4	54,0	96,1	39,0	6000
1202761	H1243640-202000	20	32,0	1 1/4"	20	1 1/4	54,0	108,6	40,0	6000
1202452	H1243640-202400	20	32,0	1 1/4"	24	1 1/2	63,5	114,8	45,5	6000
1202453	H1243640-242400	24	38,0	1 1/2"	24	1 1/2	63,5	122,9	45,0	6000
1202734	H1243640-323200	32	51,0	2"	32	2	79,4	156,6	60,0	6000

// H1243690

90° Flange SAE 6000 psi J518 Code 62

SFS 90

Solid one piece

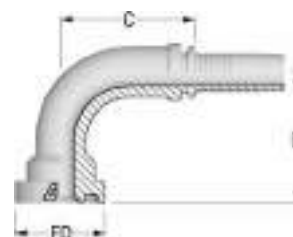

Item Code	Product Code	ID (Dash)	ID (mm)	ID (in)	F1 Dash	F1	FD (mm)	C (mm)	D Drop (mm)	WP (psi)
1202257	H1243690-080800	8	13,0	1/2"	8	1/2	31,8	47,8	46,0	6000
1202766	H1243690-081200	8	13,0	1/2"	12	3/4	41,3	47,8	54,0	6000
1202808	H1243690-100800	10	16,0	5/8"	8	1/2	31,8	50,0	52,0	6000
1202814	H1243690-101200	10	16,0	5/8"	12	3/4	41,3	49,9	55,0	6000
1202075	H1243690-121200	12	19,0	3/4"	12	3/4	41,3	63,2	61,0	6000
1201795	H1243690-121600	12	19,0	3/4"	16	1	47,6	63,2	66,0	6000
1216913	H1243690-161200	16	25,0	1"	12	3/4	41,3	72,6	61,0	6000
1201739	H1243690-161600	16	25,0	1"	16	1	47,6	73,6	75,0	6000
1202767	H1243690-162000	16	25,0	1"	20	1 1/4	54,0	77,6	78,0	6000
1202735	H1243690-202000	20	32,0	1 1/4"	20	1 1/4	54,0	94,5	89,0	6000
1202768	H1243690-202400	20	32,0	1 1/4"	24	1 1/2	63,5	98,0	94,0	6000
1202736	H1243690-242400	24	38,0	1 1/2"	24	1 1/2	63,5	99,6	105,0	6000
1202769	H1243690-243200	24	38,0	1 1/2"	32	2	79,4	116,9	123,0	6000
1202762	H1243690-323200	32	51,0	2"	32	2	79,4	143,3	132,0	6000

// H10W3320

Split Flange Clamp 3000 psi J518 Code 61

FHL



Item Code	Product Code	FD (in)	V (mm)	H (mm)
1900451	H10W3320-080000	1/2"	38,1	8,7
1900457	H10W3320-120000	3/4"	47,6	11,1
1900452	H10W3320-160000	1"	52,4	13,1
1900454	H10W3320-200000	1 1/4"	58,7	15,1
1900453	H10W3320-240000	1 1/2"	69,9	17,9
1900455	H10W3320-320000	2"	77,8	21,4
1900456	H10W3320-400000	2 1/2"	89,0	25,5
1900458	H10W3320-480000	3"	106,0	31,0
1901123	H10W3320-560000	3 1/2"	120,0	35,0
1900715	H10W3320-640000	4"	130,0	39,0

Design and dimensions shown may be changed without prior notice

// H10W3620

Split Flange Clamp 6000 psi J518 Code 62

FHS

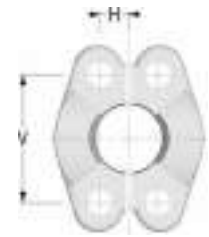

Item Code	Product Code	FD (in)	V (mm)	H (mm)
1900445	H10W3620-080000	1/2"	40,5	9,1
1900450	H10W3620-120000	3/4"	50,8	11,9
1900446	H10W3620-160000	1"	57,2	13,9
1900448	H10W3620-200000	1 1/4"	66,7	15,9
1900447	H10W3620-240000	1 1/2"	79,4	18,3
1900449	H10W3620-320000	2"	96,8	22,2

// H10W3310

4 Hole Flange Clamp 3000 psi J518 Code 61

VHL

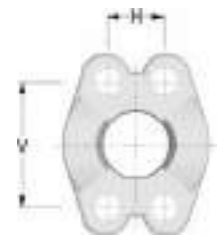

Item Code	Product Code	FD (in)	V (mm)	H (mm)
1900442	H10W3310-120000	3/4"	47,6	22,2
1900437	H10W3310-160000	1"	52,4	26,2
1900439	H10W3310-200000	1 1/4"	58,7	30,2
1900438	H10W3310-240000	1 1/2"	69,9	35,8
1900440	H10W3310-320000	2"	77,8	42,8

// H10W3610

4 Hole Flange Clamp 6000 psi J518 Code 62

VHS

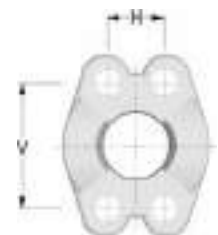

Item Code	Product Code	FD (in)	V (mm)	H (mm)
1900428	H10W3610-080000	1/2"	40,5	18,2
1900433	H10W3610-120000	3/4"	50,8	23,8
1900429	H10W3610-160000	1"	57,2	27,8
1900431	H10W3610-200000	1 1/4"	66,7	31,8
1900430	H10W3610-240000	1 1/2"	79,4	36,6
1900432	H10W3610-320000	2"	96,8	44,4
1900910	H10W3610-400000	2 1/2"	123,8	58,7



// MULTISPIRAL FITTINGS

// FERRULES.....	103	// NPTF INSERTS.....	110
// BSP INSERTS.....	104	// ORFS INSERTS.....	111
// DIN METRIC INSERTS.....	106	// SAE FLANGES.....	113
// JIC 37° INSERTS.....	108	// SUPERCAT FLANGES.....	116

Design and dimensions shown may be changed without prior notice

// FERRULES

// H1300NS4

Multispiral No-Skive Ferrule for 4 Spiral Hoses

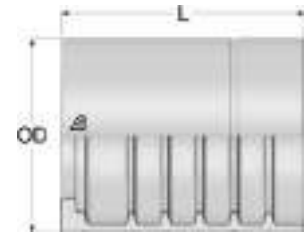

Item Code	Product Code	ID (Dash)	ID (mm)	ID (in)	Ferrule OD (mm)	L (mm)
1236599	H1300NS4-120000	12	19,0	3/4"	44,0	55,0
1236600	H1300NS4-160000	16	25,0	1"	51,0	64,0
1236601	H1300NS4-200000	20	31,0	1 1/4"	61,0	99,0
1236602	H1300NS4-240000	24	38,0	1 1/2"	70,0	89,5
1236603	H1300NS4-320000	32	51,0	2"	87,0	125,0

// H1300NS6

Multispiral No-Skive Ferrule for 6 Spiral Hoses

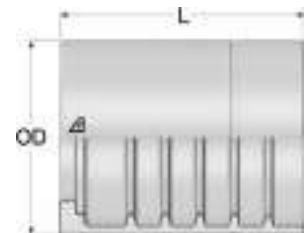

Item Code	Product Code	ID (Dash)	ID (mm)	ID (in)	Ferrule OD (mm)	L (mm)
1236604	H1300NS6-200000	20	31,0	1 1/4"	65,0	99,0
1236605	H1300NS6-240000	24	38,0	1 1/2"	73,0	89,5
1236606	H1300NS6-320000	32	51,0	2"	88,9	125,0

// H1300SK4

Multispiral Skive Ferrule for Alfabiotech/Powerflexbio Hoses

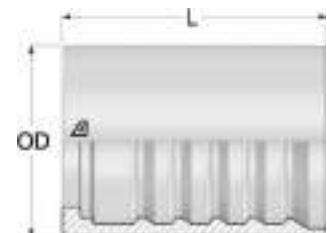

Item Code	Product Code	ID (Dash)	ID (mm)	ID (in)	Ferrule OD (mm)	L (mm)
1240185	H1300SK4-120000	12	19,0	3/4"	38,0	59,0
1240186	H1300SK4-160000	16	25,0	1"	46,0	64,0
1240187	H1300SK4-200000	20	31,0	1 1/4"	56,0	91,0
1240188	H1300SK4-240000	24	38,0	1 1/2"	62,0	91,0
1240189	H1300SK4-320000	32	51,0	2"	78,0	115,0

// BSP INSERTS

// H1310510

**BSP Male 60° Flare
AGR**

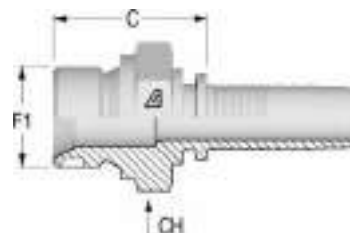

Item Code	Product Code	ID (Dash)	ID (mm)	ID (in)	F1 Dash	F1	C (mm)	CH (mm)
1238090	H1310510-121200	12	19,0	3/4"	12	3/4-14	37,5	32,0
1226162	H1310510-161600	16	25,0	1"	16	1-11	44,5	41,0
1230555	H1310510-202000	20	32,0	1 1/4"	20	1 1/4-11	95,5	50,0
1241600	H1310510-242400	24	38,0	1 1/2"	24	1 1/2-11	56,0	55,0
1241601	H1310510-323200	32	51,0	2"	32	2-11	71,5	70,0

// H1320812

**BSP Female 60° Cone with O-Ring
DKOR**

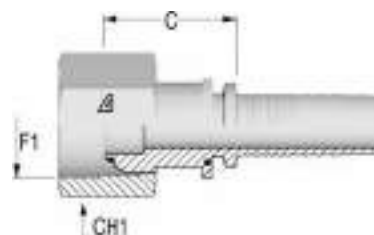

Item Code	Product Code	Nut Type	ID (Dash)	ID (mm)	ID (in)	F1 Dash	F1	C (mm)	CH1 (mm)
1226178	H1320812-121200	Thrust wire nut	12	19,0	3/4"	12	3/4-14	25,2	32,0
1241616	H1320812-121600	Thrust wire nut	12	19,0	3/4"	16	1-11	27,7	38,0
1226179	H1320812-161600	Thrust wire nut	16	25,0	1"	16	1-11	31,0	38,0
1241617	H1320812-162000	Thrust wire nut	16	25,0	1"	20	1 1/4-11	32,0	50,0
1238241	H1320812-202000	Thrust wire nut	20	32,0	1 1/4"	20	1 1/4-11	35,0	50,0
1246639	H1320812-202400	Thrust wire nut	20	32,0	1 1/4"	24	1 1/2-11	36,8	55,0
1239857	H1320812-242400	Thrust wire nut	24	38,0	1 1/2"	24	1 1/2-11	38,8	55,0
1238240	H1320812-323200	Thrust wire nut	32	51,0	2"	32	2-11	49,0	70,0

// H1320842

**45° BSP Female 60° Cone with O-Ring
DKOR 45
Solid one piece**

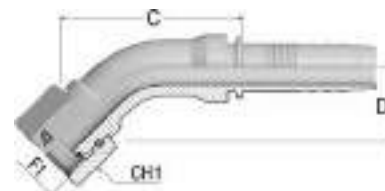

Item Code	Product Code	Nut Type	ID (Dash)	ID (mm)	ID (in)	F1 Dash	F1	C (mm)	D Drop (mm)	CH1 (mm)
1241628	H1320842-121200	Thrust wire nut	12	19,0	3/4"	12	3/4-14	75,0	30,0	32,0
1237423	H1320842-161600	Thrust wire nut	16	25,0	1"	16	1-11	92,0	40,0	38,0
1241629	H1320842-202000	Thrust wire nut	20	32,0	1 1/4"	20	1 1/4-11	90,0	40,0	50,0
1242138	H1320842-242400	Thrust wire nut	24	38,0	1 1/2"	24	1 1/2-11	116,0	46,0	55,0
1241630	H1320842-323200	Thrust wire nut	32	51,0	2"	32	2-11	153,5	60,0	70,0

Design and dimensions shown may be changed without prior notice

// H1320892
90° BSPP Female 60° Cone with O-Ring
DKOR 90
Solid one piece



Item Code	Product Code	Nut Type	ID (Dash)	ID (mm)	ID (in)	F1 Dash	F1	C (mm)	D Drop (mm)	CH1 (mm)
1226180	H1320892-121200	Thrust wire nut	12	19,0	3/4"	12	3/4-14	59,0	61,0	32,0
1226181	H1320892-161600	Thrust wire nut	16	25,0	1"	16	1-11	74,0	71,0	38,0
1241625	H1320892-202000	Thrust wire nut	20	32,0	1 1/4"	20	1 1/4-11	84,0	83,0	50,0
1238242	H1320892-242400	Thrust wire nut	24	38,0	1 1/2"	24	1 1/2-11	101,0	96,0	55,0
1241626	H1320892-323200	Thrust wire nut	32	51,0	2"	32	2-11	140,5	130,0	70,0

// DIN METRIC INSERTS

// H1311210

Metric Male 24° Seat
DIN 3853 - Heavy Series
CES

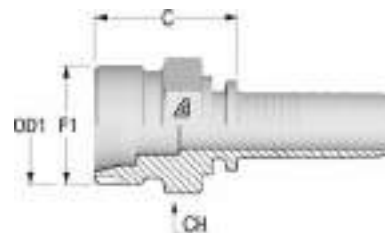

Item Code	Product Code	ID (Dash)	ID (mm)	ID (in)	F1	OD1	C (mm)	CH (mm)
1241605	H1311210-123600	12	19,0	3/4"	M36X2	25	36,5	36,0
1226164	H1311210-164200	16	25,0	1"	M42X2	30	36,2	46,0
1226165	H1311210-205200	20	32,0	1 1/4"	M52X2	38	51,0	55,0

// H1321613

Metric Female 24° Cone with O-Ring
ISO 8434-1 - Heavy Series
DKOS

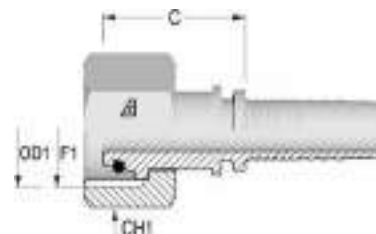

Item Code	Product Code	Nut Type	ID (Dash)	ID (mm)	ID (in)	F1	OD1	C (mm)	CH1 (mm)
1226182	H1321612-123000	Thrust wire nut	12	19,0	3/4"	M30X2	20	36,8	36,0
1240224	H1321612-163600	Thrust wire nut	16	25,0	1"	M36X2	25	46,0	46,0
1226184	H1321613-164200	Slip on nut	16	25,0	1"	M42X2	30	45,2	50,0
1242139	H1321612-204200	Thrust wire nut	20	32,0	1 1/4"	M42X2	30	51,0	50,0
1226185	H1321613-205200	Slip on nut	20	32,0	1 1/4"	M52X2	38	51,1	60,0
1238244	H1321612-245200	Thrust wire nut	24	38,0	1 1/2"	M52X2	38	58,0	60,0

Image: insert with Slip on Nut.

// H1321643

45° Metric Female 24° Cone with O-Ring
ISO 8434-1 - Heavy Series
DKOS 45
Solid one piece

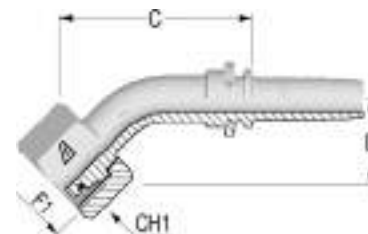

Item Code	Product Code	Nut Type	ID (Dash)	ID (mm)	ID (in)	F1	OD1	C (mm)	D Drop (mm)	CH1 (mm)
1237408	H1321643-123600	Slip on nut	12	19,0	3/4"	M36X2	25	70,4	33,0	46,0
1242140	H1321642-163600	Thrust wire nut	16	25,0	1"	M36X2	25	93,0	37,5	46,0
1237422	H1321643-164200	Slip on nut	16	25,0	1"	M42X2	30	109,5	35,5	50,0
1238246	H1321643-205200	Slip on nut	20	32,0	1 1/4"	M52X2	38	112,0	45,0	60,0

Image: insert with Slip on Nut.

Design and dimensions shown may be changed without prior notice

// H1321693
90° Metric Female 24° Cone with O-Ring
ISO 8434-1 - Heavy Series
DKOS 90
Solid one piece

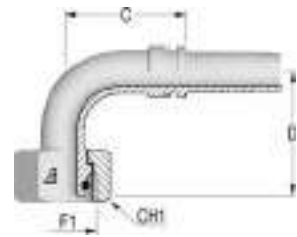

Item Code	Product Code	Nut Type	ID (Dash)	ID (mm)	ID (in)	F1	OD1	C (mm)	D Drop (mm)	CH1 (mm)
1241633	H1321692-123000	Thrust wire nut	12	19,0	3/4"	M30X2	20	65,5	67,5	36,0
1237409	H1321693-123600	Slip on nut	12	19,0	3/4"	M36X2	25	51,0	59,5	46,0
1240225	H1321692-163600	Thrust wire nut	16	25,0	1"	M36X2	25	75,6	82,0	46,0
1237410	H1321693-164200	Slip on nut	16	25,0	1"	M42X2	30	85,0	70,0	50,0
1238248	H1321693-205200	Slip on nut	20	32,0	1 1/4"	M52X2	38	97,0	92,0	60,0

Image: insert with Slip on Nut.

// JIC 37° INSERTS

// H1312510

**JIC Male 37° Cone
AGJ**

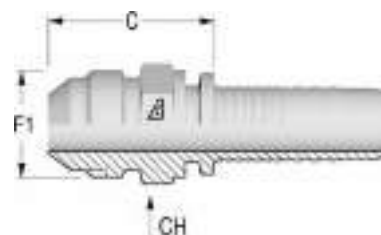

Item Code	Product Code	ID (Dash)	ID (mm)	ID (in)	F1 Dash	F1	C (mm)	CH (mm)
1226168	H1312510-121200	12	19,0	3/4"	12	1 1/16-12	38,5	27,0
1226169	H1312510-161600	16	25,0	1"	16	1 5/16-12	45,5	36,0
1226170	H1312510-202000	20	32,0	1 1/4"	20	1 5/8-12	51,5	46,0
1226171	H1312510-242400	24	38,0	1 1/2"	24	1 7/8-12	57,5	50,0
1238091	H1312510-323200	32	51,0	2"	32	2 1/2-12	77,0	65,0

// H1322512

**JIC Female 37° Seat
DKJ**

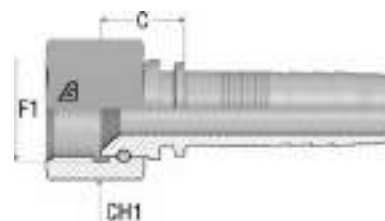

Item Code	Product Code	Nut Type	ID (Dash)	ID (mm)	ID (in)	F1 Dash	F1	C (mm)	CH1 (mm)
1241618	H1322512-121200	Thrust wire nut	12	19,0	3/4"	12	1 1/16-12	22,2	32,0
1241619	H1322512-121600	Thrust wire nut	12	19,0	3/4"	16	1 5/16-12	25,0	38,0
1241620	H1322512-161600	Thrust wire nut	16	25,0	1"	16	1 5/16-12	27,0	38,0
1241621	H1322512-162000	Thrust wire nut	16	25,0	1"	20	1 5/8-12	29,0	50,0
1241622	H1322512-202000	Thrust wire nut	20	32,0	1 1/4"	20	1 5/8-12	31,5	50,0
1241623	H1322512-202400	Thrust wire nut	20	32,0	1 1/4"	24	1 7/8-12	34,0	55,0
1241624	H1322512-242400	Thrust wire nut	24	38,0	1 1/2"	24	1 7/8-12	36,5	55,0

// H1322542

**45° JIC Female 37° Seat
Medium Drop
DKJ 45M
Solid one piece**

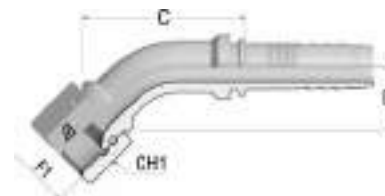

Item Code	Product Code	Nut Type	ID (Dash)	ID (mm)	ID (in)	F1 Dash	F1	C (mm)	D Drop (mm)	CH1 (mm)
1226205	H1322542-121200	Thrust wire nut	12	19,0	3/4"	12	1 1/16-12	69,5	27,5	32,0
1241631	H1322542-121600	Thrust wire nut	12	19,0	3/4"	16	1 5/16-12	69,0	33,5	38,0
1226206	H1322542-161600	Thrust wire nut	16	25,0	1"	16	1 5/16-12	84,8	31,0	38,0
1238251	H1322542-202000	Thrust wire nut	20	32,0	1 1/4"	20	1 5/8-12	99,0	37,0	50,0
1226207	H1322542-242400	Thrust wire nut	24	38,0	1 1/2"	24	1 7/8-12	118,3	43,5	55,0

Design and dimensions shown may be changed without prior notice

// H1322592
90° JIC Female 37° Seat
Medium Drop
DKJ 90M
Solid one piece

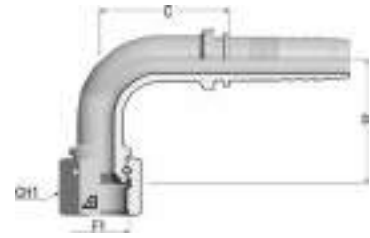

Item Code	Product Code	Nut Type	ID (Dash)	ID (mm)	ID (in)	F1 Dash	F1	C (mm)	D Drop (mm)	CH1 (mm)
1226209	H1322592-121200	Thrust wire nut	12	19,0	3/4"	12	1 1/16-12	59,1	57,0	32,0
1226211	H1322592-121600	Thrust wire nut	12	19,0	3/4"	16	1 5/16-12	58,1	63,5	38,0
1226212	H1322592-161600	Thrust wire nut	16	25,0	1"	16	1 5/16-12	75,7	67,0	38,0
1238254	H1322592-202000	Thrust wire nut	20	32,0	1 1/4"	20	1 5/8-12	84,0	78,0	50,0
1230690	H1322592-242400	Thrust wire nut	24	38,0	1 1/2"	24	1 7/8-12	105,3	92,0	55,0
1238255	H1322592-323200	Thrust wire nut	32	51,0	2"	32	2 1/2-12	147,5	135,0	70,0

// NPTF INSERTS

// H1312810

**NPTF Male 60° Seat
AGN**

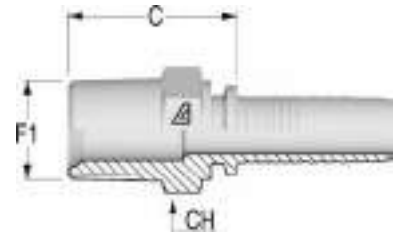

Item Code	Product Code	ID (Dash)	ID (mm)	ID (in)	F1 Dash	F1	C (mm)	CH (mm)
1226172	H1312810-121200	12	19,0	3/4"	12	3/4-14	35,5	27,0
1226173	H1312810-161600	16	25,0	1"	16	1-11 1/2	46,5	36,0
1238093	H1312810-202000	20	32,0	1 1/4"	20	1 1/4-11 1/2	41,0	46,0
1238095	H1312810-323200	32	51,0	2"	32	2-11 1/2	69,2	65,0

Design and dimensions shown may be changed without prior notice

// ORFS INSERTS

// H1312410

ORFS Male

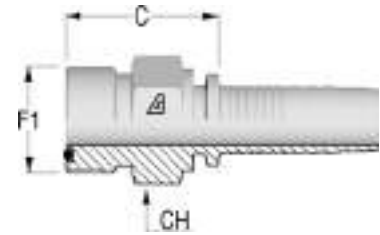

Item Code	Product Code	ID (Dash)	ID (mm)	ID (in)	F1 Dash	F1	C (mm)	CH (mm)
1230556	H1312410-121200	12	19,0	3/4"	12	1 3/16-12	32,7	32,0
1226166	H1312410-161600	16	25,0	1"	16	1 7/16-12	35,7	38,0
1230557	H1312410-202000	20	32,0	1 1/4"	20	1 11/16-12	38,7	46,0
1226167	H1312410-242400	24	38,0	1 1/2"	24	2-12	41,8	55,0

// H1322411

ORFS Female with Stem Hexagon

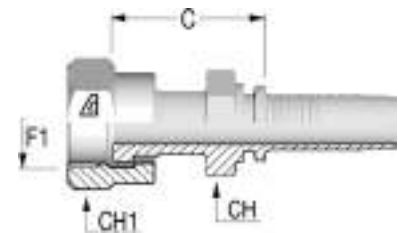

Item Code	Product Code	Nut Type	ID (Dash)	ID (mm)	ID (in)	F1 Dash	F1	C (mm)	CH (mm)	CH1 (mm)
1226190	H1322411-121200	Crimped	12	19,0	3/4"	12	1 3/16-12	44,5	30,0	36,0
1226191	H1322411-121600	Crimped	12	19,0	3/4"	16	1 7/16-12	50,5	36,0	41,0
1242141	H1322411-161200	Crimped	16	25,0	1"	12	1 3/16-12	42,0	32,0	36,0
1226192	H1322411-161600	Crimped	16	25,0	1"	16	1 7/16-12	52,5	36,0	41,0
1226193	H1322411-162000	Crimped	16	25,0	1"	20	1 11/16-12	53,5	41,0	50,0
1226194	H1322411-202000	Crimped	20	32,0	1 1/4"	20	1 11/16-12	56,0	41,0	50,0
1226195	H1322411-242400	Crimped	24	38,0	1 1/2"	24	2-12	62,5	50,0	60,0

// H1322441

45° ORFS Female

Medium Drop

DK ORFS 45M

Solid one piece

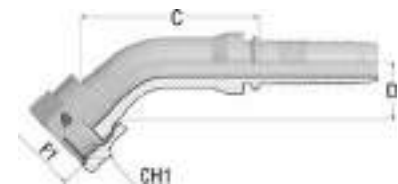

Item Code	Product Code	Nut Type	ID (Dash)	ID (mm)	ID (in)	F1 Dash	F1	C (mm)	D Drop (mm)	CH1 (mm)
1226196	H1322441-121200	Crimped	12	19,0	3/4"	12	1 3/16-12	32,5	26,0	36,0
1226197	H1322441-121600	Crimped	12	19,0	3/4"	16	1 7/16-12	31,2	28,0	41,0
1226198	H1322441-161600	Crimped	16	25,0	1"	16	1 7/16-12	94,0	28,0	41,0
1241634	H1322441-162000	Crimped	16	25,0	1"	20	1 11/16-12	88,0	28,0	50,0
1238249	H1322441-202000	Crimped	20	32,0	1 1/4"	20	1 11/16-12	110,0	36,5	50,0

// H1322491
90° ORFS Female
Medium Drop
DK ORFS 90M
Solid one piece

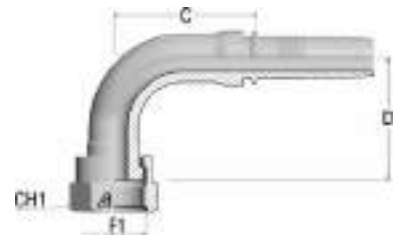

Item Code	Product Code	Nut Type	ID (Dash)	ID (mm)	ID (in)	F1 Dash	F1	C (mm)	D Drop (mm)	CH1 (mm)
1226200	H1322491-121200	Crimped	12	19,0	3/4"	12	1 3/16-12	67,6	58,0	36,0
1226201	H1322491-121600	Crimped	12	19,0	3/4"	16	1 7/16-12	69,6	58,0	36,0
1226202	H1322491-161600	Crimped	16	25,0	1"	16	1 7/16-12	79,6	66,0	41,0
1241635	H1322491-162000	Crimped	16	25,0	1"	20	1 11/16-12	73,0	66,0	50,0
1226203	H1322491-202000	Crimped	20	32,0	1 1/4"	20	1 11/16-12	102,4	81,0	50,0

Design and dimensions shown may be changed without prior notice

// SAE FLANGES

// H1343310

Flange SAE 3000 psi J518 Code 61
SFL

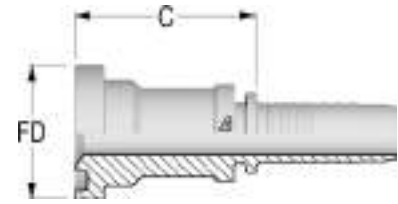

Item Code	Product Code	ID (Dash)	ID (mm)	ID (in)	F1 Dash	F1	FD (mm)	C (mm)	WP (psi)
1226222	H1343310-121200	12	19,0	3/4"	12	3/4	38,1	43,5	5000
1226224	H1343310-161600	16	25,0	1"	16	1	44,5	53,5	5000
1226225	H1343310-162000	16	25,0	1"	20	1 1/4	50,8	56,0	5000
1241602	H1343310-201600	20	32,0	1 1/4"	16	1	44,4	58,5	5000
1226227	H1343310-202000	20	32,0	1 1/4"	20	1 1/4	50,8	58,5	5000
1241604	H1343310-202400	20	32,0	1 1/4"	24	1 1/2	60,3	61,5	5000
1241603	H1343310-242000	24	38,0	1 1/2"	20	1 1/4	50,8	55,5	5000
1226228	H1343310-242400	24	38,0	1 1/2"	24	1 1/2	60,3	63,5	5000
1226229	H1343310-243200	24	38,0	1 1/2"	32	2	71,4	75,0	5000
1235374	H1343310-323200	32	50,0	2"	32	2	71,4	85,0	5000

// H1343340

45° Flange SAE 3000 psi J518 Code 61
SFL 45
Solid one piece

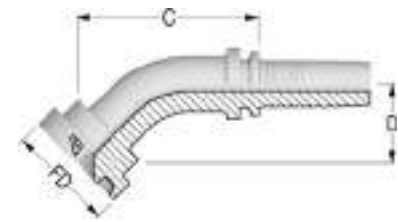

Item Code	Product Code	ID (Dash)	ID (mm)	ID (in)	F1 Dash	F1	FD (mm)	C (mm)	D Drop (mm)	WP (psi)
1226233	H1343340-162000	16	25,0	1"	20	1 1/4	50,8	88,9	32,5	5000
1226234	H1343340-202000	20	32,0	1 1/4"	20	1 1/4	50,8	94,3	38,5	5000
1226235	H1343340-242400	24	38,0	1 1/2"	24	1 1/2	60,3	99,8	43,0	5000
1233534	H1343340-323200	32	50,0	2"	32	2	71,4	154,0	54,0	5000

// H1343390

90° Flange SAE 3000 psi J518 Code 61

SFL 90

Solid one piece

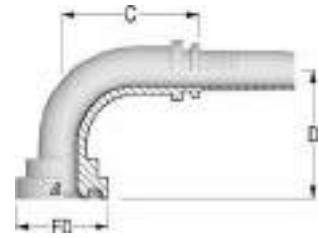

Item Code	Product Code	ID (Dash)	ID (mm)	ID (in)	F1 Dash	F1	FD (mm)	C (mm)	D Drop (mm)	WP (psi)
1226241	H1343390-161600	16	25,0	1"	16	1	44,5	78,1	64,0	5000
1226242	H1343390-162000	16	25,0	1"	20	1 1/4	50,8	74,7	69,0	5000
1226244	H1343390-202000	20	32,0	1 1/4"	20	1 1/4	50,8	92,0	81,0	5000
1241608	H1343390-202400	20	32,0	1 1/4"	24	1 1/2	60,3	87,0	85,0	5000
1226245	H1343390-242400	24	38,0	1 1/2"	24	1 1/2	60,3	103,0	93,0	5000
1235375	H1343390-323200	32	50,0	2"	32	2	71,4	139,0	130,0	5000

// H1343610

Flange SAE 6000 psi J518 Code 62

SFS

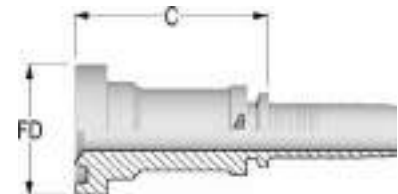

Item Code	Product Code	ID (Dash)	ID (mm)	ID (in)	F1 Dash	F1	FD (mm)	C (mm)	WP (psi)
1226247	H1343610-121200	12	19,0	3/4"	12	3/4	41,3	53,5	6000
1226248	H1343610-121600	12	19,0	3/4"	16	1	47,6	56,5	6000
1226623	H1343610-161200	16	25,0	1"	12	3/4	41,3	58,5	6000
1226250	H1343610-161600	16	25,0	1"	16	1	47,6	58,5	6000
1226624	H1343610-162000	16	25,0	1"	20	1 1/4	54,0	65,5	6000
1236992	H1343610-201600	20	32,0	1 1/4"	16	1	47,6	61,0	6000
1226252	H1343610-202000	20	32,0	1 1/4"	20	1 1/4	54,0	64,0	6000
1226253	H1343610-202400	20	32,0	1 1/4"	24	1 1/2	63,5	74,0	6000
1241614	H1343610-242000	24	38,0	1 1/2"	20	1 1/4	54,0	71,0	6000
1226254	H1343610-242400	24	38,0	1 1/2"	24	1 1/2	63,5	76,0	6000
1226255	H1343610-243200	24	38,0	1 1/2"	32	2	79,4	88,0	6000
1241615	H1343610-322400	32	51,0	2"	24	1 1/2	63,5	86,0	6000
1235378	H1343610-323200	32	50,0	2"	32	2	79,4	103,0	6000

Design and dimensions shown may be changed without prior notice

// H1343640

45° Flange SAE 6000 psi J518 Code 62

SFS 45

Solid one piece

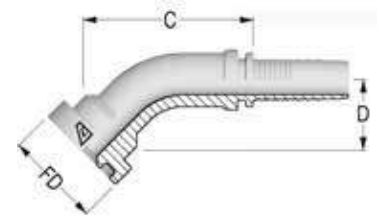

Item Code	Product Code	ID (Dash)	ID (mm)	ID (in)	F1 Dash	F1	FD (mm)	C (mm)	D Drop (mm)	WP (psi)
1226261	H1343640-121200	12	19,0	3/4"	12	3/4	41,3	62,8	30,0	6000
1226262	H1343640-121600	12	19,0	3/4"	16	1	47,6	65,4	33,0	6000
1241609	H1343640-161200	16	25,0	1"	12	3/4	41,3	77,0	29,5	6000
1226263	H1343640-161600	16	25,0	1"	16	1	47,6	82,9	38,5	6000
1226264	H1343640-162000	16	25,0	1"	20	1 1/4	54,0	78,0	44,0	6000
1242142	H1343640-201600	20	32,0	1 1/4"	16	1	47,6	104,7	34,5	6000
1238305	H1343640-202000	20	32,0	1 1/4"	20	1 1/4	54,0	103,0	41,0	6000
1241610	H1343640-202400	20	32,0	1 1/4"	24	1 1/2	63,5	117,0	48,0	6000
1226265	H1343640-242400	24	38,0	1 1/2"	24	1 1/2	63,5	122,5	48,0	6000
1235379	H1343640-323200	32	50,0	2"	32	2	79,4	177,0	61,0	6000

// H1343690

90° Flange SAE 6000 psi J518 Code 62

SFS 90

Solid one piece

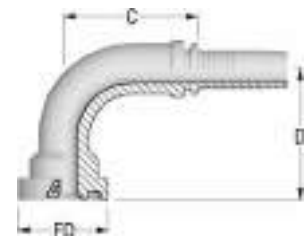

Item Code	Product Code	ID (Dash)	ID (mm)	ID (in)	F1 Dash	F1	FD (mm)	C (mm)	D Drop (mm)	WP (psi)
1226270	H1343690-121200	12	19,0	3/4"	12	3/4	41,3	64,7	64,0	6000
1226271	H1343690-121600	12	19,0	3/4"	16	1	47,6	64,7	66,0	6000
1226633	H1343690-161200	16	25,0	1"	12	3/4	41,3	74,7	61,0	6000
1226273	H1343690-161600	16	25,0	1"	16	1	47,6	74,8	74,0	6000
1226274	H1343690-162000	16	25,0	1"	20	1 1/4	54,0	78,8	85,0	6000
1241611	H1343690-201600	20	32,0	1 1/4"	16	1	47,6	87,0	72,0	6000
1230765	H1343690-202000	20	32,0	1 1/4"	20	1 1/4	54,0	96,0	91,0	6000
1238310	H1343690-202400	20	32,0	1 1/4"	24	1 1/2	63,5	99,0	103,5	6000
1226276	H1343690-242400	24	38,0	1 1/2"	24	1 1/2	63,5	113,8	109,0	6000
1235381	H1343690-323200	32	50,0	2"	32	2	79,4	169,0	134,0	6000

// SUPERCAT FLANGES

// H1343910

Flange SUPERCAT

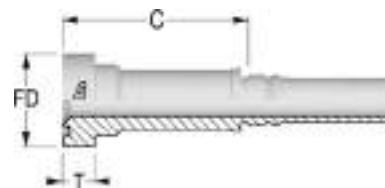

Item Code	Product Code	ID (Dash)	ID (mm)	ID (in)	F1 Dash	F1	FD (mm)	T (mm)	C (mm)
1226278	H1343910-121200	12	19,0	3/4"	12	3/4	41,3	14,3	85,5
1226279	H1343910-121600	12	19,0	3/4"	16	1	47,6	14,3	85,5
1226280	H1343910-161600	16	25,0	1"	16	1	47,6	14,3	94,5
1226281	H1343910-162000	16	25,0	1"	20	1 1/4	54,0	14,3	94,5
1226282	H1343910-202000	20	32,0	1 1/4"	20	1 1/4	54,0	14,3	92,0
1226283	H1343910-202400	20	32,0	1 1/4"	24	1 1/2	63,5	14,3	87,0

// H1343940

45° Flange SUPERCAT

Solid one piece

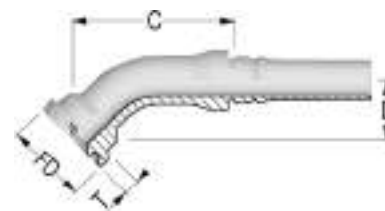

Item Code	Product Code	ID (Dash)	ID (mm)	ID (in)	F1 Dash	F1	FD (mm)	T (mm)	C (mm)	D Drop (mm)
1226289	H1343940-121200	12	19,0	3/4"	12	3/4	41,3	14,3	107,0	34,0
1241612	H1343940-121600	12	19,0	3/4"	16	1	47,6	14,3	112,0	34,0
1226290	H1343940-161600	16	25,0	1"	16	1	47,6	14,3	129,0	42,5
1226291	H1343940-162000	16	25,0	1"	20	1 1/4	54,0	14,3	128,0	40,0
1226292	H1343940-202000	20	32,0	1 1/4"	20	1 1/4	54,0	14,3	150,0	45,1
1238317	H1343940-202400	20	32,0	1 1/4"	24	1 1/2	63,5	14,3	152,0	60,0

// H1343990

90° Flange SUPERCAT

Solid one piece

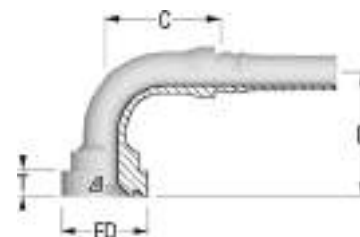

Item Code	Product Code	ID (Dash)	ID (mm)	ID (in)	F1 Dash	F1	FD (mm)	T (mm)	C (mm)	D Drop (mm)
1226297	H1343990-121200	12	19,0	3/4"	12	3/4	41,3	14,3	67,2	67,0
1226298	H1343990-121600	12	19,0	3/4"	16	1	47,6	14,3	68,7	70,0
1226299	H1343990-161600	16	25,0	1"	16	1	47,6	14,3	84,8	79,0
1226301	H1343990-162000	16	25,0	1"	20	1 1/4	54,0	14,3	79,8	82,5
1238312	H1343990-202000	20	32,0	1 1/4"	20	1 1/4	54,0	14,3	97,0	93,0
1238315	H1343990-202400	20	32,0	1 1/4"	24	1 1/2	63,5	14,3	97,0	101,0



// NEW INTERLOCK FITTINGS

// FERRULES.....	118	// NPTF INSERTS.....	126
// HOSE MENDER.....	119	// ORFS INSERTS.....	127
// BSP INSERTS.....	120	// SAE FLANGES.....	129
// DIN METRIC INSERTS.....	122	// SUPERCAT FLANGES.....	132
// JIC 37° INSERTS.....	124		

// FERRULES

// H1700200

Interlock Dual Skive Ferrule for 4 Spiral Hoses

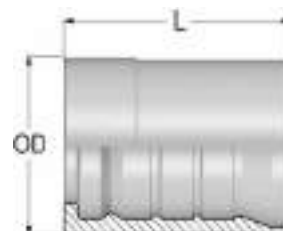

Item Code	Product Code	ID (Dash)	ID (mm)	ID (in)	Ferrule OD (mm)	L (mm)
1251401	H1700200-120000	12	19,0	3/4"	38,0	48,7
1251403	H1700200-160000	16	25,0	1"	46,0	55,7
1251406	H1700200-200000	20	31,0	1 1/4"	55,0	66,0
1251409	H1700200-240000	24	38,0	1 1/2"	62,0	68,0
1251466	H1700200-320000	32	51,0	2"	78,0	79,5

// H1700301

Interlock Dual Skive Ferrule for 4-6 Spiral Hoses

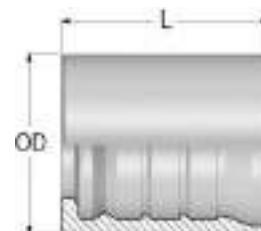

Item Code	Product Code	ID (Dash)	ID (mm)	ID (in)	Ferrule OD (mm)	L (mm)
1251399	H1700301-100000	10	16,0	5/8"	35,5	46,0
1254787	H1700301-120000	12	19,0	3/4"	42,5	48,7
1254788	H1700301-160000	16	25,0	1"	52,0	55,7
1251405	H1700301-200000	20	31,0	1 1/4"	62,0	66,0
1251408	H1700301-240000	24	38,0	1 1/2"	69,5	68,0
1254090	H1700301-320000	32	51,0	2"	88,0	79,5

Design and dimensions shown may be changed without prior notice

// HOSE MENDER

// H17C5610

Hose Mender

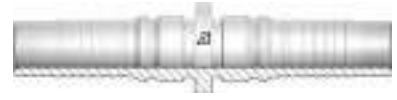

Item Code	Product Code	ID (Dash)	ID (mm)	ID (in)
1254483	H17C5610-101000	10	16,0	5/8"
1255020	H17C5610-202000	20	32,0	1 1/4"

// BSP INSERTS

// H1710510

**BSP Male 60° Flare
AGR**

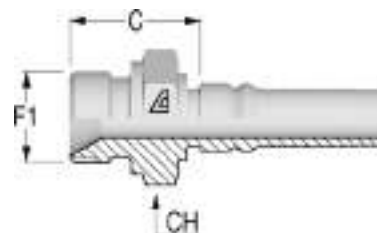

Item Code	Product Code	ID (Dash)	ID (mm)	ID (in)	F1 Dash	F1	C (mm)	CH (mm)
1254467	H1710510-121200	12	19,0	3/4"	12	3/4-14	34,0	32,0
1254465	H1710510-161600	16	25,0	1"	16	1-11	40,0	41,0
1255015	H1710510-202000	20	32,0	1 1/4"	20	1 1/4-11	45,2	50,0
1255116	H1710510-242400	24	38,0	1 1/2"	24	1 1/2-11	48,5	55,0

// H1720812

**BSP Female 60° Cone with O-Ring
DKOR**

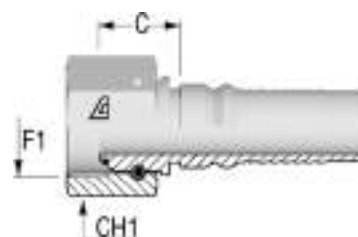

Item Code	Product Code	Nut Type	ID (Dash)	ID (mm)	ID (in)	F1 Dash	F1	C (mm)	CH1 (mm)
1254447	H1720812-121200	Thrust wire nut	12	19,0	3/4"	12	3/4-14	22,5	32,0
1254448	H1720812-161600	Thrust wire nut	16	25,0	1"	16	1-11	25,5	38,0
1255009	H1720812-202000	Thrust wire nut	20	32,0	1 1/4"	20	1 1/4-11	30,2	50,0
1255097	H1720812-242400	Thrust wire nut	24	38,0	1 1/2"	24	1 1/2-11	33,5	55,0

Image: insert with Thrust Wire Nut.

// H1720842

**45° BSP Female 60° Cone with O-Ring
DKOR 45
Solid one piece**

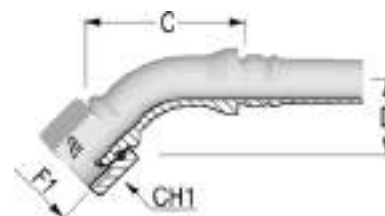

Item Code	Product Code	Nut Type	ID (Dash)	ID (mm)	ID (in)	F1 Dash	F1	C (mm)	D Drop (mm)	CH1 (mm)
1254217	H1720842-121200	Thrust wire nut	12	19,0	3/4"	12	3/4-14	72,0	30,0	32,0
1254218	H1720842-161600	Thrust wire nut	16	25,0	1"	16	1-11	81,0	34,0	38,0
1254898	H1720842-202000	Thrust wire nut	20	32,0	1 1/4"	20	1 1/4-11	97,0	40,0	50,0
1255119	H1720842-242400	Thrust wire nut	24	38,0	1 1/2"	24	1 1/2-11	113,0	46,0	55,0

Design and dimensions shown may be changed without prior notice

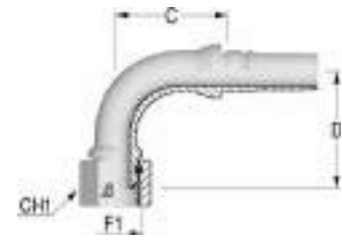
// H1720892**90° BSPP Female 60° Cone with O-Ring****DKOR 90****Solid one piece**

Item Code	Product Code	Nut Type	ID (Dash)	ID (mm)	ID (in)	F1 Dash	F1	C (mm)	D Drop (mm)	CH1 (mm)
1254203	H1720892-121200	Thrust wire nut	12	19,0	3/4"	12	3/4-14	58,0	61,0	32,0
1254212	H1720892-161600	Thrust wire nut	16	25,0	1"	16	1-11	75,0	71,0	38,0
1254830	H1720892-202000	Thrust wire nut	20	32,0	1 1/4"	20	1 1/4-11	79,0	83,0	50,0
1255111	H1720892-242400	Thrust wire nut	24	38,0	1 1/2"	24	1 1/2-11	93,0	96,0	55,0

// DIN METRIC INSERTS

// H1711210

Metric Male 24° Seat
DIN 3853 - Heavy Series
CES

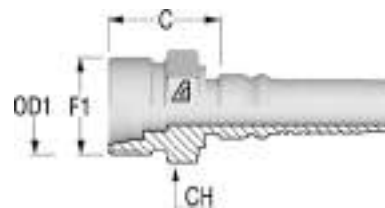

Item Code	Product Code	ID (Dash)	ID (mm)	ID (in)	F1	OD1	C (mm)	CH (mm)
1254527	H1711210-103000	10	16,0	5/8"	M30X2	20	31,0	32,0
1254442	H1711210-123600	12	19,0	3/4"	M36X2	25	35,0	36,0
1254443	H1711210-164200	16	25,0	1"	M42X2	30	40,0	46,0
1255008	H1711210-205200	20	32,0	1 1/4"	M52X2	38	45,2	55,0

// H1721613

Metric Female 24° Cone with O-Ring
ISO 8434-1 - Heavy Series
DKOS

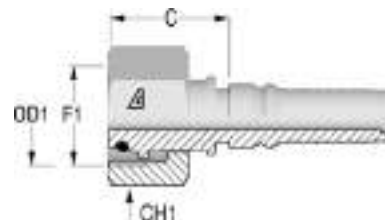

Item Code	Product Code	Nut Type	ID (Dash)	ID (mm)	ID (in)	F1	OD1	C (mm)	CH1 (mm)
1254282	H1721613-103000	Slip on nut	10	16,0	5/8"	M30X2	20	34,4	36,0
1254440	H1721612-123000	Thrust wire nut	12	19,0	3/4"	M30X2	20	37,5	36,0
1254281	H1721613-123600	Slip on nut	12	19,0	3/4"	M36X2	25	37,6	46,0
1254441	H1721612-163600	Thrust wire nut	16	25,0	1"	M36X2	25	38,8	46,0
1254280	H1721613-164200	Slip on nut	16	25,0	1"	M42X2	30	40,7	50,0
1254801	H1721612-204200	Thrust wire nut	20	32,0	1 1/4"	M42X2	30	43,2	50,0
1254776	H1721613-205200	Slip on nut	20	32,0	1 1/4"	M52X2	38	45,3	60,0
1255093	H1721612-245200	Thrust wire nut	24	38,0	1 1/2"	M52X2	38	50,8	60,0

Image: insert with Slip on Nut.

Design and dimensions shown may be changed without prior notice

// H1721643

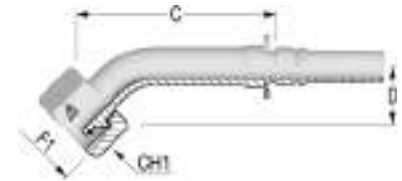
45° Metric Female 24° Cone with O-Ring**ISO 8434-1 - Heavy Series****DKOS****Solid one piece**

Item Code	Product Code	Nut Type	ID (Dash)	ID (mm)	ID (in)	F1	OD1	C (mm)	D Drop (mm)	CH1 (mm)
1254459	H1721643-103000	Slip on nut	10	16,0	5/8"	M30X2	20	59,0	31,5	36,0
1254486	H1721642-123000	Thrust wire nut	12	19,0	3/4"	M30X2	20	74,0	33,0	36,0
1254458	H1721643-123600	Slip on nut	12	19,0	3/4"	M36X2	25	78,1	36,0	46,0
1254216	H1721642-163600	Thrust wire nut	16	25,0	1"	M36X2	25	86,5	37,5	46,0
1254195	H1721643-164200	Slip on nut	16	25,0	1"	M42X2	30	96,8	38,0	50,0
1254819	H1721643-205200	Slip on nut	20	32,0	1 1/4"	M52X2	38	113,0	48,0	60,0
1255118	H1721642-245200	Thrust wire nut	24	38,0	1 1/2"	M52X2	38	111,0	44,0	60,0

Image: insert with Slip on Nut.

// H1721693

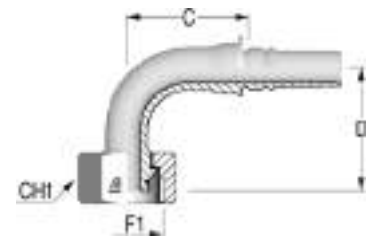
90° Metric Female 24° Cone with O-Ring**ISO 8434-1 - Heavy Series****DKOS 90****Solid one piece**

Item Code	Product Code	Nut Type	ID (Dash)	ID (mm)	ID (in)	F1	OD1	C (mm)	D Drop (mm)	CH1 (mm)
1254451	H1721693-103000	Slip on nut	10	16,0	5/8"	M30X2	20	48,0	55,0	36,0
1254460	H1721692-123000	Thrust wire nut	12	19,0	3/4"	M30X2	20	61,0	67,5	36,0
1254449	H1721693-123600	Slip on nut	12	19,0	3/4"	M36X2	25	61,7	65,0	46,0
1254197	H1721692-163600	Thrust wire nut	16	25,0	1"	M36X2	25	76,5	82,0	46,0
1254450	H1721693-164200	Slip on nut	16	25,0	1"	M42X2	30	86,4	79,0	50,0
1254812	H1721693-205200	Slip on nut	20	32,0	1 1/4"	M52X2	38	90,9	101,0	60,0
1255109	H1721692-245200	Thrust wire nut	24	38,0	1 1/2"	M52X2	38	100,5	102,0	60,0

Image: insert with Slip on Nut.

// JIC 37° INSERTS

// H1712510

JIC Male 37° Cone
AGJ

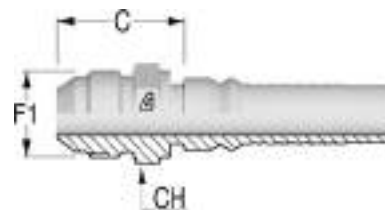

Item Code	Product Code	ID (Dash)	ID (mm)	ID (in)	F1 Dash	F1	C (mm)	CH (mm)
1254481	H1712510-121200	12	19,0	3/4"	12	1 1/16-12	37,0	32,0
1254720	H1712510-121600	12	19,0	3/4"	16	1 5/16-12	40,0	36,0
1254263	H1712510-161600	16	25,0	1"	16	1 5/16-12	41,0	36,0
1254736	H1712510-162000	16	25,0	1"	20	1 5/8-12	44,5	46,0
1255019	H1712510-202000	20	32,0	1 1/4"	20	1 5/8-12	45,7	46,0
1255018	H1712510-202400	20	32,0	1 1/4"	24	1 7/8-12	49,7	50,0
1255134	H1712510-242400	24	38,0	1 1/2"	24	1 7/8-12	50,0	50,0

// H1722512

JIC Female 37° Seat
DKJ

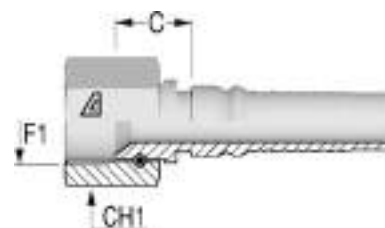

Item Code	Product Code	Nut Type	ID (Dash)	ID (mm)	ID (in)	F1 Dash	F1	C (mm)	CH1 (mm)
1254455	H1722512-121200	Thrust wire nut	12	19,0	3/4"	12	1 1/16-12	18,7	32,0
1254530	H1722512-121600	Thrust wire nut	12	19,0	3/4"	16	1 5/16-12	21,5	38,0
1254454	H1722512-161600	Thrust wire nut	16	25,0	1"	16	1 5/16-12	22,5	38,0
1254700	H1722512-162000	Thrust wire nut	16	25,0	1"	20	1 5/8-12	24,5	50,0
1251404	H1722512-202000	Thrust wire nut	20	32,0	1 1/4"	20	1 5/8-12	25,7	50,0
1251407	H1722512-242400	Thrust wire nut	24	38,0	1 1/2"	24	1 7/8-12	29,0	55,0
1251465	H1722512-323200	Thrust wire nut	32	51,0	2"	32	2 1/2-12	34,0	70,0

Design and dimensions shown may be changed without prior notice

// H1722542
45° JIC Female 37° Seat
DKJ 45
Solid one piece

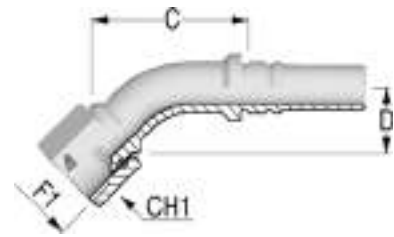

Item Code	Product Code	Nut Type	ID (Dash)	ID (mm)	ID (in)	F1 Dash	F1	C (mm)	D Drop (mm)	CH1 (mm)
1254512	H1722542-121200	Thrust wire nut	12	19,0	3/4"	12	1 1/16-12	66,0	27,5	32,0
1254727	H1722542-121600	Thrust wire nut	12	19,0	3/4"	16	1 5/16-12	72,0	30,0	38,0
1254265	H1722542-161600	Thrust wire nut	16	25,0	1"	16	1 5/16-12	80,0	31,0	38,0
1255002	H1722542-202000	Thrust wire nut	20	32,0	1 1/4"	20	1 5/8-12	93,0	37,0	50,0
1255137	H1722542-242400	Thrust wire nut	24	38,0	1 1/2"	24	1 7/8-12	121,0	40,5	55,0

// H1722592
90° JIC Female 37° Seat
DKJ 90
Solid one piece

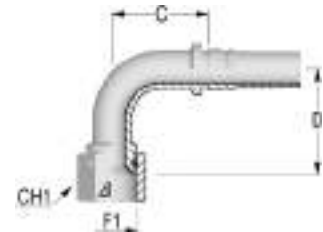

Item Code	Product Code	Nut Type	ID (Dash)	ID (mm)	ID (in)	F1 Dash	F1	C (mm)	D Drop (mm)	CH1 (mm)
1254491	H1722592-121200	Thrust wire nut	12	19,0	3/4"	12	1 1/16-12	45,0	57,0	32,0
1254260	H1722592-161600	Thrust wire nut	16	25,0	1"	16	1 5/16-12	71,0	67,0	38,0
1254903	H1722592-202000	Thrust wire nut	20	32,0	1 1/4"	20	1 5/8-12	79,2	78,0	50,0
1255130	H1722592-242400	Thrust wire nut	24	38,0	1 1/2"	24	1 7/8-12	94,5	92,0	55,0

// NPTF INSERTS

// H1712810

**NPTF Male 60° Seat
AGN**

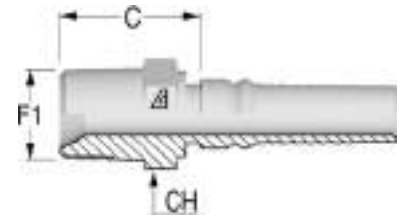

Item Code	Product Code	ID (Dash)	ID (mm)	ID (in)	F1 Dash	F1	C (mm)	CH (mm)
1254531	H1712810-121200	12	19,0	3/4"	12	3/4-14	32,0	27,0
1254464	H1712810-161600	16	25,0	1"	16	1-11 1/2	42,0	36,0
1254837	H1712810-202000	20	32,0	1 1/4"	20	1 1/4-11 1/2	46,2	46,0
1255115	H1712810-242400	24	38,0	1 1/2"	24	1 1/2-11 1/2	48,0	50,0

Design and dimensions shown may be changed without prior notice

// ORFS INSERTS

// H1712410

ORFS Male

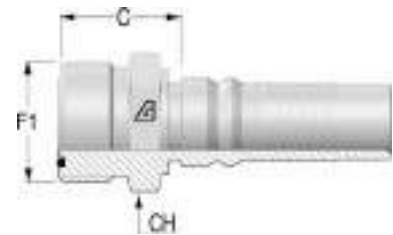

Item Code	Product Code	ID (Dash)	ID (mm)	ID (in)	F1 Dash	F1	C (mm)	CH (mm)
1254479	H1712410-121200	12	19,0	3/4"	12	1 3/16-12	30,2	30,0
1254510	H1712410-161600	16	25,0	1"	16	1 7/16-12	35,8	38,0
1254904	H1712410-202000	20	32,0	1 1/4"	20	1 11/16-12	38,7	46,0

// H1722411

ORFS Female with Stem Hexagon

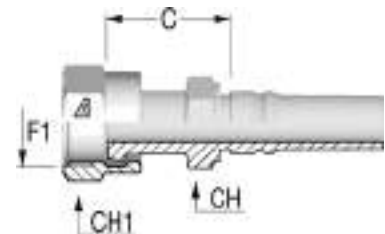

Item Code	Product Code	Nut Type	ID (Dash)	ID (mm)	ID (in)	F1 Dash	F1	C (mm)	CH (mm)	CH1 (mm)
1254292	H1722411-121200	Crimped	12	19,0	3/4"	12	1 3/16-12	40,0	30,0	36,0
1254439	H1722411-121600	Crimped	12	19,0	3/4"	16	1 7/16-12	43,0	36,0	41,0
1254471	H1722411-161200	Crimped	16	25,0	1"	12	1 3/16-12	42,0	32,0	36,0
1254438	H1722411-161600	Crimped	16	25,0	1"	16	1 7/16-12	47,0	36,0	41,0
1254513	H1722411-162000	Crimped	16	25,0	1"	20	1 11/16-12	49,0	46,0	50,0
1254800	H1722411-202000	Crimped	20	32,0	1 1/4"	20	1 11/16-12	47,2	46,0	50,0
1255091	H1722411-242400	Crimped	24	38,0	1 1/2"	24	2-12	52,0	50,0	60,0

// H1722441

45° ORFS Female

DK ORFS 45

Solid one piece

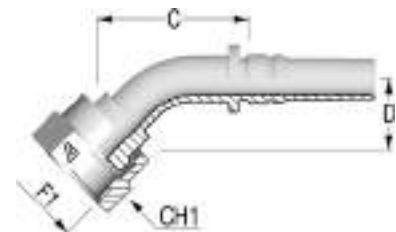

Item Code	Product Code	Nut Type	ID (Dash)	ID (mm)	ID (in)	F1 Dash	F1	C (mm)	D Drop (mm)	CH1 (mm)
1254463	H1722441-121200	Crimped	12	19,0	3/4"	12	1 3/16-12	78,0	26,0	36,0
1254461	H1722441-121600	Crimped	12	19,0	3/4"	16	1 7/16-12	68,4	28,0	41,0
1254462	H1722441-161600	Crimped	16	25,0	1"	16	1 7/16-12	114,0	28,0	41,0
1254201	H1722441-162000	Crimped	16	25,0	1"	20	1 11/16-12	83,4	28,0	50,0
1254823	H1722441-202000	Crimped	20	32,0	1 1/4"	20	1 11/16-12	100,7	33,0	50,0

// H1722491
90° ORFS Female
DK ORFS 90
Solid one piece



Item Code	Product Code	Nut Type	ID (Dash)	ID (mm)	ID (in)	F1 Dash	F1	C (mm)	D Drop (mm)	CH1 (mm)
1254452	H1722491-121200	Crimped	12	19,0	3/4"	12	1 3/16-12	64,2	58,0	36,0
1254518	H1722491-121600	Crimped	12	19,0	3/4"	16	1 7/16-12	66,2	58,0	41,0
1254453	H1722491-161600	Crimped	16	25,0	1"	16	1 7/16-12	75,2	66,0	41,0
1254694	H1722491-162000	Crimped	16	25,0	1"	20	1 11/16-12	73,2	66,0	50,0
1254816	H1722491-202000	Crimped	20	32,0	1 1/4"	20	1 11/16-12	91,7	81,0	50,0

Design and dimensions shown may be changed without prior notice

// SAE FLANGES

// H1743310

Flange SAE 3000 psi J518 Code 61
SFL

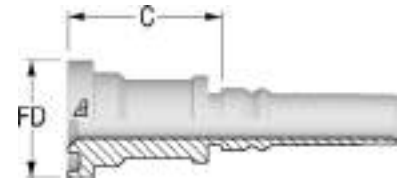

Item Code	Product Code	ID (Dash)	ID (mm)	ID (in)	F1 Dash	F1	FD (mm)	C (mm)	WP (psi)
1254456	H1743310-161600	16	25,0	1"	16	1	44,5	49,0	5000
1254177	H1743310-162000	16	25,0	1"	20	1 1/4	50,8	51,5	4000
1255010	H1743310-202000	20	32,0	1 1/4"	20	1 1/4	50,8	52,7	4000
1254817	H1743310-202400	20	32,0	1 1/4"	24	1 1/2	60,3	55,7	3000
1255063	H1743310-242400	24	38,0	1 1/2"	24	1 1/2	60,3	56,0	3000
1255083	H1743310-243200	24	38,0	1 1/2"	32	2	71,4	67,5	3000

// H1743340

45° Flange SAE 3000 psi J518 Code 61
SFL 45
Solid one piece

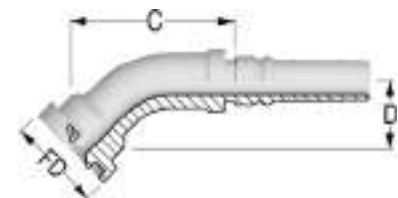

Item Code	Product Code	ID (Dash)	ID (mm)	ID (in)	F1 Dash	F1	FD (mm)	C (mm)	D Drop (mm)	WP (psi)
1254245	H1743340-162000	16	25,0	1"	20	1 1/4	50,8	95,6	30,0	4000
1254901	H1743340-202000	20	32,0	1 1/4"	20	1 1/4	50,8	100,9	32,5	4000
1254902	H1743340-202400	20	32,0	1 1/4"	24	1 1/2	60,3	92,8	40,0	3000
1255122	H1743340-242400	24	38,0	1 1/2"	24	1 1/2	60,3	103,7	43,0	3000

// H1743390

90° Flange SAE 3000 psi J518 Code 61
SFL 90
Solid one piece



Item Code	Product Code	ID (Dash)	ID (mm)	ID (in)	F1 Dash	F1	FD (mm)	C (mm)	D Drop (mm)	WP (psi)
1254178	H1743390-161600	16	25,0	1"	16	1	44,5	72,2	64,0	5000
1254180	H1743390-162000	16	25,0	1"	20	1 1/4	50,8	70,2	69,0	4000
1254834	H1743390-202000	20	32,0	1 1/4"	20	1 1/4	50,8	86,2	81,0	4000
1254835	H1743390-202400	20	32,0	1 1/4"	24	1 1/2	60,3	81,2	85,0	3000
1255112	H1743390-242400	24	38,0	1 1/2"	24	1 1/2	60,3	96,0	93,0	3000
1255113	H1743390-243200	24	38,0	1 1/2"	32	2	71,4	130,0	97,0	3000

// H1743610

Flange SAE 6000 psi J518 Code 62
SFS

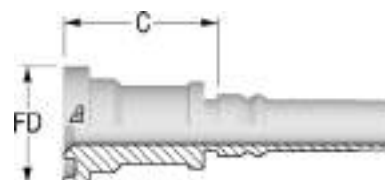

Item Code	Product Code	ID (Dash)	ID (mm)	ID (in)	F1 Dash	F1	FD (mm)	C (mm)	WP (psi)
1251400	H1743610-121200	12	19,0	3/4"	12	3/4	41,3	50,0	6000
1254286	H1743610-121600	12	19,0	3/4"	16	1	47,6	53,0	6000
1254284	H1743610-161200	16	25,0	1"	12	3/4	41,3	51,0	6000
1251402	H1743610-161600	16	25,0	1"	16	1	47,6	54,0	6000
1254283	H1743610-162000	16	25,0	1"	20	1 1/4	54,0	61,0	6000
1254778	H1743610-201600	20	32,0	1 1/4"	16	1	47,6	80,2	6000
1254777	H1743610-202000	20	32,0	1 1/4"	20	1 1/4	54,0	62,2	6000
1254779	H1743610-202400	20	32,0	1 1/4"	24	1 1/2	63,5	68,2	6000
1255054	H1743610-242000	24	38,0	1 1/2"	20	1 1/4	54,0	62,5	6000
1255053	H1743610-242400	24	38,0	1 1/2"	24	1 1/2	63,5	68,5	6000
1255062	H1743610-243200	24	38,0	1 1/2"	32	2	79,4	80,5	6000
1254820	H1743610-323200	32	51,0	2"	32	2	79,4	87,0	6000

// H1743640

45° Flange SAE 6000 psi J518 Code 62
SFS 45
Solid one piece

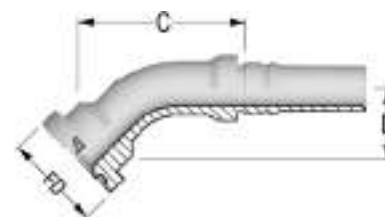

Item Code	Product Code	ID (Dash)	ID (mm)	ID (in)	F1 Dash	F1	FD (mm)	C (mm)	D Drop (mm)	WP (psi)
1254446	H1743640-121200	12	19,0	3/4"	12	3/4	41,3	72,1	30,0	6000
1254161	H1743640-121600	12	19,0	3/4"	16	1	47,6	76,8	33,0	6000
1254475	H1743640-161200	16	25,0	1"	12	3/4	41,3	80,3	29,5	6000
1254445	H1743640-161600	16	25,0	1"	16	1	47,6	94,8	35,0	6000
1254165	H1743640-162000	16	25,0	1"	20	1 1/4	54,0	105,3	44,0	6000
1254803	H1743640-201600	20	32,0	1 1/4"	16	1	47,6	104,7	34,5	6000
1254802	H1743640-202000	20	32,0	1 1/4"	20	1 1/4	54,0	102,0	39,5	6000
1254811	H1743640-202400	20	32,0	1 1/4"	24	1 1/2	63,5	111,7	48,0	6000
1255094	H1743640-242400	24	38,0	1 1/2"	24	1 1/2	63,5	136,3	48,0	6000
1255096	H1743640-243200	24	38,0	1 1/2"	32	2	79,4	129,1	55,0	6000

Design and dimensions shown may be changed without prior notice

// H1743690

90° Flange SAE 6000 psi J518 Code 62

SFS 90

Solid one piece

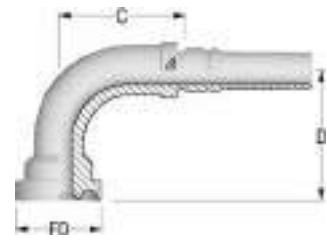

Item Code	Product Code	ID (Dash)	ID (mm)	ID (in)	F1 Dash	F1	FD (mm)	C (mm)	D Drop (mm)	WP (psi)
1254287	H1743690-121200	12	19,0	3/4"	12	3/4	41,3	61,2	64,0	6000
1254146	H1743690-121600	12	19,0	3/4"	16	1	47,6	61,2	66,0	6000
1254288	H1743690-161200	16	25,0	1"	12	3/4	41,3	70,2	61,0	6000
1254144	H1743690-161600	16	25,0	1"	16	1	47,6	70,4	74,0	6000
1254145	H1743690-162000	16	25,0	1"	20	1 1/4	54,0	77,2	80,0	6000
1254786	H1743690-202000	20	32,0	1 1/4"	20	1 1/4	54,0	88,2	91,0	6000
1254794	H1743690-202400	20	32,0	1 1/4"	24	1 1/2	63,5	92,9	103,5	6000
1255087	H1743690-242400	24	38,0	1 1/2"	24	1 1/2	63,5	106,3	109,0	6000
1255089	H1743690-243200	24	38,0	1 1/2"	32	2	79,4	106,5	121,5	6000

// SUPERCAT FLANGES

// H1743910

Flange SUPERCAT

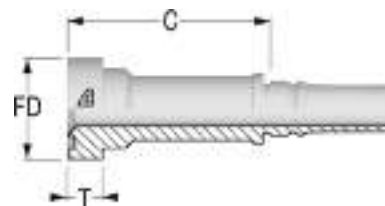

Item Code	Product Code	ID (Dash)	ID (mm)	ID (in)	F1 Dash	F1	FD (mm)	T (mm)	C (mm)
1254735	H1743910-121200	12	19,0	3/4"	12	3/4	41,3	14,3	82,0
1254241	H1743910-121600	12	19,0	3/4"	16	1	47,6	14,3	82,0
1254223	H1743910-161600	16	25,0	1"	16	1	47,6	14,3	90,0
1254240	H1743910-162000	16	25,0	1"	20	1 1/4	54,0	14,3	90,0
1254899	H1743910-202000	20	32,0	1 1/4"	20	1 1/4	54,0	14,3	86,2
1254900	H1743910-202400	20	32,0	1 1/4"	24	1 1/2	63,5	14,3	83,2

// H1743940

45° Flange SUPERCAT

Solid one piece

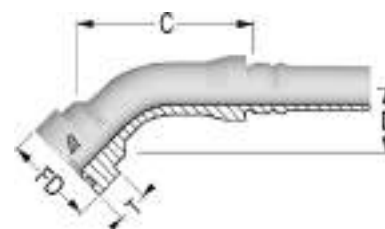

Item Code	Product Code	ID (Dash)	ID (mm)	ID (in)	F1 Dash	F1	FD (mm)	T (mm)	C (mm)	D Drop (mm)
1254721	H1743940-121200	12	19,0	3/4"	12	3/4	41,3	14,3	83,0	34,0
1254258	H1743940-121600	12	19,0	3/4"	16	1	47,6	14,3	87,4	34,0
1254256	H1743940-161600	16	25,0	1"	16	1	47,6	14,3	93,9	40,0
1254257	H1743940-162000	16	25,0	1"	20	1 1/4	54,0	14,3	95,4	40,0
1254908	H1743940-202000	20	32,0	1 1/4"	20	1 1/4	54,0	14,3	103,6	43,0
1254907	H1743940-202400	20	32,0	1 1/4"	24	1 1/2	63,5	14,3	110,1	49,5

// H1743990

90° Flange SUPERCAT

Solid one piece

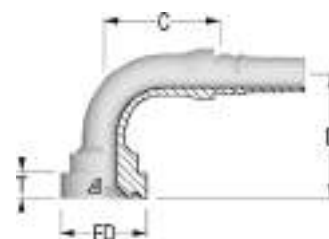

Item Code	Product Code	ID (Dash)	ID (mm)	ID (in)	F1 Dash	F1	FD (mm)	T (mm)	C (mm)	D Drop (mm)
1254251	H1743990-121200	12	19,0	3/4"	12	3/4	41,3	14,3	63,7	67,0
1254253	H1743990-121600	12	19,0	3/4"	16	1	47,6	14,3	65,2	70,0
1254250	H1743990-161600	16	25,0	1"	16	1	47,6	14,3	80,4	79,0
1254252	H1743990-162000	16	25,0	1"	20	1 1/4	54,0	14,3	75,4	82,5
1254905	H1743990-202000	20	32,0	1 1/4"	20	1 1/4	54,0	14,3	89,2	93,0
1254906	H1743990-202400	20	32,0	1 1/4"	24	1 1/2	63,5	14,3	91,4	101,0



// INTERLOCK FITTINGS

// FERRULES.....	134	// NPTF INSERTS.....	142
// HOSE MENDER.....	135	// ORFS INSERTS.....	143
// BSP INSERTS.....	136	// SAE FLANGES.....	145
// DIN METRIC INSERTS.....	138	// SUPERCAT FLANGES.....	149
// JIC 37° INSERTS.....	140	// HAMMER UNION.....	150

// FERRULES

// H1400200

Interlock Dual Skive Ferrule for 4 Spiral Hoses

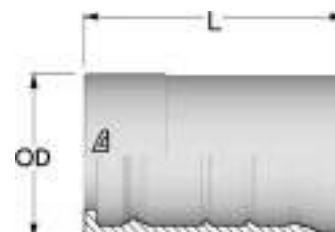

Item Code	Product Code	ID (Dash)	ID (mm)	ID (in)	Ferrule OD (mm)	L (mm)
1201571	H1400200-060000	6	10,0	3/8"	27,0	49,0
1201856	H1400200-080000	8	13,0	1/2"	30,0	52,5
1201502	H1400200-100000	10	16,0	5/8"	34,0	57,5
1201503	H1400200-120000	12	19,0	3/4"	38,0	60,2
1201504	H1400200-160000	16	25,0	1"	46,0	74,7
1200098	H1400200-200000	20	31,0	1 1/4"	55,0	88,2
1200099	H1400200-240000	24	38,0	1 1/2"	62,0	94,2
1201284	H1400200-320000	32	51,0	2"	78,0	99,2

// H1400301

Interlock Dual Skive Ferrule for 4-6 Spiral Hoses

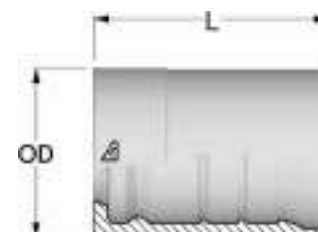

Item Code	Product Code	ID (Dash)	ID (mm)	ID (in)	Ferrule OD (mm)	L (mm)
1202585	H1400301-100000	10	16,0	5/8"	35,5	57,5
1202730	H1400301-120000	12	19,0	3/4"	42,5	60,0
1202222	H1400301-160000	16	25,0	1"	52,0	75,0
1201761	H1400301-200000	20	31,0	1 1/4"	62,0	88,0
1201805	H1400301-240000	24	38,0	1 1/2"	69,5	94,0
1202006	H1400301-320000	32	51,0	2"	88,0	99,0

// H1T00600

Interlock Dual Skive Ferrule for Alfabiotech/Powerflexbio 3K and AT8K

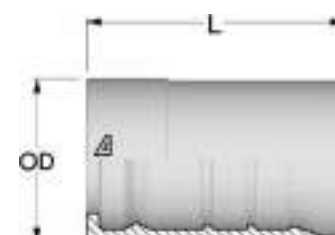

Item Code	Product Code	ID (Dash)	ID (mm)	ID (in)	Ferrule OD (mm)	L (mm)
1225872	H1T00600-320000	32	51,0	2"	88,1	108,2

Design and dimensions shown may be changed without prior notice

// HOSE MENDER

// H14C5610

Hose Mender

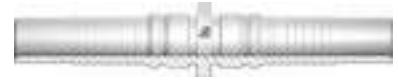

Item Code	Product Code	ID (Dash)	ID (mm)	ID (in)
1219636	H14C5610-101000	10	16,0	5/8"
1235392	H14C5610-202000	20	32,0	1 1/4"
1235393	H14C5610-242400	24	38,0	1 1/2"
1235394	H14C5610-323200	32	51,0	2"

// BSP INSERTS

// H1410510

**BSP Male 60° Flare
AGR**

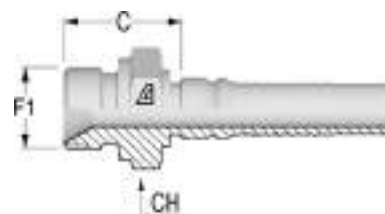

Item Code	Product Code	ID (Dash)	ID (mm)	ID (in)	F1 Dash	F1	C (mm)	CH (mm)
1200218	H1410510-121200	12	19,0	3/4"	12	3/4-14	34,0	32,0
1200239	H1410510-161600	16	25,0	1"	16	1-11	40,0	41,0
1201219	H1410510-202000	20	32,0	1 1/4"	20	1 1/4-11	45,2	50,0
1200280	H1410510-242400	24	38,0	1 1/2"	24	1 1/2-11	48,5	55,0
1201080	H1410510-323200	32	51,0	2"	32	2-11	55,5	70,0

// H1410710

**BSPT Male
AGR K**

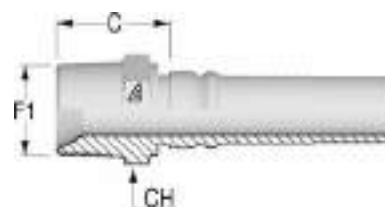

Item Code	Product Code	ID (Dash)	ID (mm)	ID (in)	F1 Dash	F1	C (mm)	CH (mm)
1200215	H1410710-121200	12	19,0	3/4"	12	3/4-14	32,0	27,0
1200237	H1410710-161600	16	25,0	1"	16	1-11	42,0	36,0
1200261	H1410710-202000	20	32,0	1 1/4"	20	1 1/4-11	46,2	46,0
1200278	H1410710-242400	24	38,0	1 1/2"	24	1 1/2-11	48,0	50,0

// H1420812

**BSP Female 60° Cone with O-Ring
DKOR**

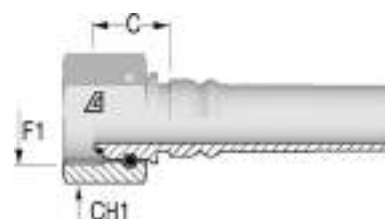

Item Code	Product Code	Nut Type	ID (Dash)	ID (mm)	ID (in)	F1 Dash	F1	C (mm)	CH1 (mm)
1214247	H1420811-080800	Crimped	8	13,0	1/2"	8	1/2-14	19,5	27,0
1202424	H1420812-121200	Thrust wire nut	12	19,0	3/4"	12	3/4-14	22,5	32,0
1202440	H1420812-161600	Thrust wire nut	16	25,0	1"	16	1-11	25,5	38,0
1201132	H1420812-202000	Thrust wire nut	20	32,0	1 1/4"	20	1 1/4-11	30,2	50,0
1201134	H1420812-242400	Thrust wire nut	24	38,0	1 1/2"	24	1 1/2-11	33,5	55,0
1201136	H1420812-323200	Thrust wire nut	32	51,0	2"	32	2-11	35,0	70,0

Image: insert with Thrust Wire Nut.

Design and dimensions shown may be changed without prior notice

// H1420842

45° BSPP Female 60° Cone with O-Ring

DKOR 45

Solid one piece

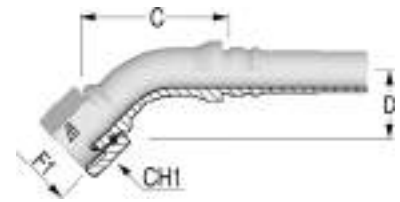

Item Code	Product Code	Nut Type	ID (Dash)	ID (mm)	ID (in)	F1 Dash	F1	C (mm)	D Drop (mm)	CH1 (mm)
1202447	H1420842-121200	Thrust wire nut	12	19,0	3/4"	12	3/4-14	72,0	30,0	32,0
1202446	H1420842-161600	Thrust wire nut	16	25,0	1"	16	1-11	81,0	34,0	38,0
1202444	H1420842-202000	Thrust wire nut	20	32,0	1 1/4"	20	1 1/4-11	97,0	40,0	50,0
1202442	H1420842-242400	Thrust wire nut	24	38,0	1 1/2"	24	1 1/2-11	113,0	46,0	55,0
1201535	H1420842-323200	Thrust wire nut	32	51,0	2"	32	2-11	151,0	60,0	70,0

// H1420892

90° BSPP Female 60° Cone with O-Ring

DKOR 90

Solid one piece



Item Code	Product Code	Nut Type	ID (Dash)	ID (mm)	ID (in)	F1 Dash	F1	C (mm)	D Drop (mm)	CH1 (mm)
1200217	H1420892-121200	Thrust wire nut	12	19,0	3/4"	12	3/4-14	58,0	61,0	32,0
1202445	H1420892-161600	Thrust wire nut	16	25,0	1"	16	1-11	75,0	71,0	38,0
1202443	H1420892-202000	Thrust wire nut	20	32,0	1 1/4"	20	1 1/4-11	79,0	83,0	50,0
1202441	H1420892-242400	Thrust wire nut	24	38,0	1 1/2"	24	1 1/2-11	93,0	96,0	55,0
1200288	H1420892-323200	Thrust wire nut	32	51,0	2"	32	2-11	134,0	130,0	70,0

// DIN METRIC INSERTS

// H1411210

Metric Male 24° Seat
DIN 3853 - Heavy Series
CES

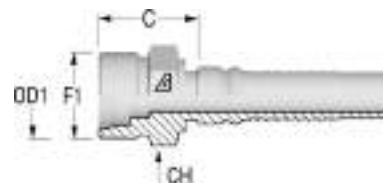

Item Code	Product Code	ID (Dash)	ID (mm)	ID (in)	F1	OD1	C (mm)	CH (mm)
1216929	H1411210-082400	8	13,0	1/2"	M24X1.5	16	27,0	24,0
1201077	H1411210-103000	10	16,0	5/8"	M30X2	20	31,0	32,0
1200212	H1411210-123600	12	19,0	3/4"	M36X2	25	35,0	36,0
1200236	H1411210-164200	16	25,0	1"	M42X2	30	40,0	46,0
1200260	H1411210-205200	20	32,0	1 1/4"	M52X2	38	45,2	55,0

// H1421613

Metric Female 24° Cone with O-Ring
ISO 8434-1 - Heavy Series
DKOS

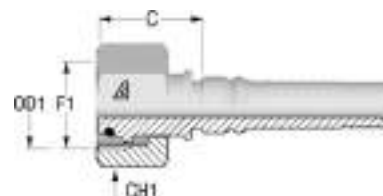

Item Code	Product Code	Nut Type	ID (Dash)	ID (mm)	ID (in)	F1	OD1	C (mm)	CH1 (mm)
1201857	H1421613-082400	Slip on nut	8	13,0	1/2"	M24X1.5	16	29,6	30,0
1201118	H1421613-103000	Slip on nut	10	16,0	5/8"	M30X2	20	34,4	36,0
1202584	H1421612-123000	Thrust wire nut	12	19,0	3/4"	M30X2	20	37,5	36,0
1201092	H1421613-123600	Slip on nut	12	19,0	3/4"	M36X2	25	37,6	46,0
1202887	H1421612-163600	Thrust wire nut	16	25,0	1"	M36X2	25	38,8	46,0
1201125	H1421613-164200	Slip on nut	16	25,0	1"	M42X2	30	40,7	50,0
1216935	H1421612-204200	Thrust wire nut	20	32,0	1 1/4"	M42X2	30	43,2	50,0
1201129	H1421613-205200	Slip on nut	20	32,0	1 1/4"	M52X2	38	45,3	60,0
1216936	H1421612-245200	Thrust wire nut	24	38,0	1 1/2"	M52X2	38	50,8	60,0

Image: insert with Slip on Nut.

Design and dimensions shown may be changed without prior notice

// H1421643

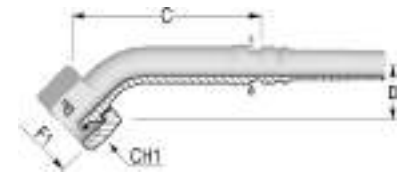
45° Metric Female 24° Cone with O-Ring**ISO 8434-1 - Heavy Series****DKOS****Solid one piece**

Item Code	Product Code	Nut Type	ID (Dash)	ID (mm)	ID (in)	F1	OD1	C (mm)	D Drop (mm)	CH1 (mm)
1216942	H1421643-082400	Slip on nut	8	13,0	1/2"	M24X1.5	16	83,0	29,0	30,0
1202073	H1421643-103000	Slip on nut	10	16,0	5/8"	M30X2	20	59,0	31,5	36,0
1202583	H1421642-123000	Thrust wire nut	12	19,0	3/4"	M30X2	20	74,0	33,0	36,0
1202079	H1421643-123600	Slip on nut	12	19,0	3/4"	M36X2	25	78,1	36,0	46,0
1216940	H1421642-163600	Thrust wire nut	16	25,0	1"	M36X2	25	86,5	37,5	46,0
1201724	H1421643-164200	Slip on nut	16	25,0	1"	M42X2	30	96,8	38,0	50,0
1202003	H1421643-205200	Slip on nut	20	32,0	1 1/4"	M52X2	38	113,0	48,0	60,0
1216941	H1421642-245200	Thrust wire nut	24	38,0	1 1/2"	M52X2	38	111,0	44,0	60,0

Image: insert with Slip on Nut.

// H1421693

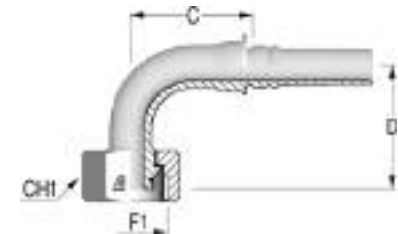
90° Metric Female 24° Cone with O-Ring**ISO 8434-1 - Heavy Series****DKOS 90****Solid one piece**

Item Code	Product Code	Nut Type	ID (Dash)	ID (mm)	ID (in)	F1	OD1	C (mm)	D Drop (mm)	CH1 (mm)
1203125	H1421693-082400	Slip on nut	8	13,0	1/2"	M24X1.5	16	52,0	50,0	30,0
1202072	H1421693-103000	Slip on nut	10	16,0	5/8"	M30X2	20	48,0	55,0	36,0
1202582	H1421692-123000	Thrust wire nut	12	19,0	3/4"	M30X2	20	61,0	67,5	36,0
1201723	H1421693-123600	Slip on nut	12	19,0	3/4"	M36X2	25	61,7	65,0	46,0
1203126	H1421692-163600	Thrust wire nut	16	25,0	1"	M36X2	25	76,5	82,0	46,0
1201740	H1421693-164200	Slip on nut	16	25,0	1"	M42X2	30	86,4	79,0	50,0
1201059	H1421693-205200	Slip on nut	20	32,0	1 1/4"	M52X2	38	90,9	101,0	60,0
1216945	H1421692-245200	Thrust wire nut	24	38,0	1 1/2"	M52X2	38	100,5	102,0	60,0

Image: insert with Slip on Nut.

// JIC 37° INSERTS

// H1412510

JIC Male 37° Cone
AGJ

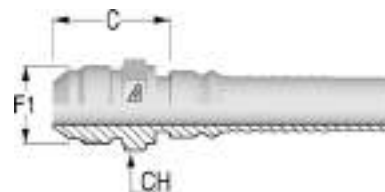

Item Code	Product Code	ID (Dash)	ID (mm)	ID (in)	F1 Dash	F1	C (mm)	CH (mm)
1200216	H1412510-121200	12	19,0	3/4"	12	1 1/16-12	37,0	32,0
1201094	H1412510-121600	12	19,0	3/4"	16	1 5/16-12	40,0	36,0
1200238	H1412510-161600	16	25,0	1"	16	1 5/16-12	41,0	36,0
1201787	H1412510-162000	16	25,0	1"	20	1 5/8-12	44,5	46,0
1200262	H1412510-202000	20	32,0	1 1/4"	20	1 5/8-12	45,7	46,0
1216931	H1412510-202400	20	32,0	1 1/4"	24	1 7/8-12	49,7	50,0
1200279	H1412510-242400	24	38,0	1 1/2"	24	1 7/8-12	50,0	50,0
1201798	H1412510-323200	32	51,0	2"	32	2 1/2-12	61,0	65,0

// H1422512

JIC Female 37° Seat
DKJ

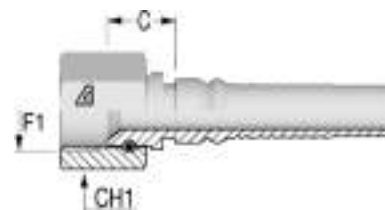

Item Code	Product Code	Nut Type	ID (Dash)	ID (mm)	ID (in)	F1 Dash	F1	C (mm)	CH1 (mm)
1201265	H1422512-101200	Thrust wire nut	10	16,0	5/8"	12	1 1/16-12	18,7	32,0
1201121	H1422512-121200	Thrust wire nut	12	19,0	3/4"	12	1 1/16-12	18,7	32,0
1201122	H1422512-121600	Thrust wire nut	12	19,0	3/4"	16	1 5/16-12	21,5	38,0
1201126	H1422512-161600	Thrust wire nut	16	25,0	1"	16	1 5/16-12	22,5	38,0
1201127	H1422512-162000	Thrust wire nut	16	25,0	1"	20	1 5/8-12	24,5	50,0
1201131	H1422512-202000	Thrust wire nut	20	32,0	1 1/4"	20	1 5/8-12	25,7	50,0
1216973	H1422512-202400	Thrust wire nut	20	32,0	1 1/4"	24	1 7/8-12	28,2	55,0
1201133	H1422512-242400	Thrust wire nut	24	38,0	1 1/2"	24	1 7/8-12	29,0	55,0
1201135	H1422512-323200	Thrust wire nut	32	51,0	2"	32	2 1/2-12	34,0	70,0

Design and dimensions shown may be changed without prior notice

// H1422542
45° JIC Female 37° Seat
DKJ 45
Solid one piece

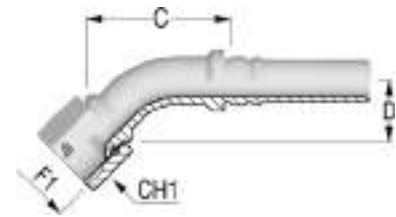

Item Code	Product Code	Nut Type	ID (Dash)	ID (mm)	ID (in)	F1 Dash	F1	C (mm)	D Drop (mm)	CH1 (mm)
1201485	H1422542-121200	Thrust wire nut	12	19,0	3/4"	12	1 1/16-12	66,0	27,5	32,0
1202098	H1422542-121600	Thrust wire nut	12	19,0	3/4"	16	1 5/16-12	72,0	30,0	38,0
1201486	H1422542-161600	Thrust wire nut	16	25,0	1"	16	1 5/16-12	80,0	31,0	38,0
1201487	H1422542-202000	Thrust wire nut	20	32,0	1 1/4"	20	1 5/8-12	93,0	37,0	50,0
1201765	H1422542-242400	Thrust wire nut	24	38,0	1 1/2"	24	1 7/8-12	121,0	40,5	55,0

// H1422592
90° JIC Female 37° Seat
DKJ 90
Solid one piece



Item Code	Product Code	Nut Type	ID (Dash)	ID (mm)	ID (in)	F1 Dash	F1	C (mm)	D Drop (mm)	CH1 (mm)
1201488	H1422592-121200	Thrust wire nut	12	19,0	3/4"	12	1 1/16-12	45,0	57,0	32,0
1202103	H1422592-121600	Thrust wire nut	12	19,0	3/4"	16	1 5/16-12	58,0	60,5	38,0
1201489	H1422592-161600	Thrust wire nut	16	25,0	1"	16	1 5/16-12	71,0	67,0	38,0
1201490	H1422592-202000	Thrust wire nut	20	32,0	1 1/4"	20	1 5/8-12	79,2	78,0	50,0
1201491	H1422592-242400	Thrust wire nut	24	38,0	1 1/2"	24	1 7/8-12	94,5	92,0	55,0
1201796	H1422592-323200	Thrust wire nut	32	51,0	2"	32	2 1/2-12	132,0	120,5	70,0

// NPTF INSERTS

// H1412810

**NPTF Male 60° Seat
AGN**

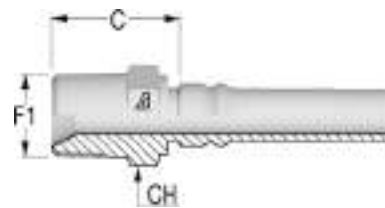

Item Code	Product Code	ID (Dash)	ID (mm)	ID (in)	F1 Dash	F1	C (mm)	CH (mm)
1201609	H1412810-060600	6	10,0	3/8"	6	3/8-18	26,5	19,0
1203127	H1412810-080800	8	13,0	1/2"	8	1/2-14	30,0	22,0
1200193	H1412810-121200	12	19,0	3/4"	12	3/4-14	32,0	27,0
1200219	H1412810-161600	16	25,0	1"	16	1-11 1/2	42,0	36,0
1200240	H1412810-202000	20	32,0	1 1/4"	20	1 1/4-11 1/2	46,2	46,0
1200263	H1412810-242400	24	38,0	1 1/2"	24	1 1/2-11 1/2	48,0	50,0
1200281	H1412810-323200	32	51,0	2"	32	2-11 1/2	53,2	65,0

Design and dimensions shown may be changed without prior notice

// ORFS INSERTS

// H1412410

ORFS Male

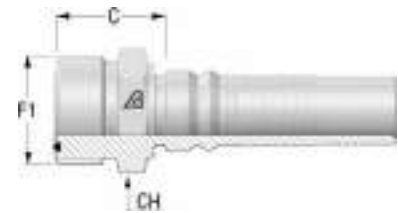

Item Code	Product Code	ID (Dash)	ID (mm)	ID (in)	F1 Dash	F1	C (mm)	CH (mm)
1214664	H1412410-121200	12	19,0	3/4"	12	1 3/16-12	30,2	30,0
1231483	H1412410-161600	16	25,0	1"	16	1 7/16-12	35,8	38,0
1226310	H1412410-202000	20	32,0	1 1/4"	20	1 11/16-12	38,7	46,0
1226312	H1412410-242400	24	38,0	1 1/2"	24	2-12	41,0	55,0

// H1422411

ORFS Female with Stem Hexagon

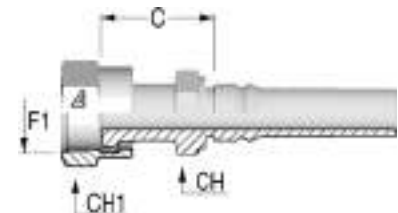

Item Code	Product Code	Nut Type	ID (Dash)	ID (mm)	ID (in)	F1 Dash	F1	C (mm)	CH (mm)	CH1 (mm)
1202864	H1422411-101200	Crimped	10	16,0	5/8"	12	1 3/16-12	40,0	30,0	36,0
1202099	H1422411-121200	Crimped	12	19,0	3/4"	12	1 3/16-12	40,0	30,0	36,0
1202106	H1422411-121600	Crimped	12	19,0	3/4"	16	1 7/16-12	43,0	36,0	41,0
1216952	H1422411-161200	Crimped	16	25,0	1"	12	1 3/16-12	42,0	32,0	36,0
1202071	H1422411-161600	Crimped	16	25,0	1"	16	1 7/16-12	47,0	36,0	41,0
1202107	H1422411-162000	Crimped	16	25,0	1"	20	1 11/16-12	49,0	46,0	50,0
1216955	H1422411-201600	Crimped	20	32,0	1 1/4"	16	1 7/16-12	47,2	41,0	41,0
1201807	H1422411-202000	Crimped	20	32,0	1 1/4"	20	1 11/16-12	47,2	46,0	50,0
1216956	H1422411-242400	Crimped	24	38,0	1 1/2"	24	2-12	52,0	50,0	60,0

// H1422441

45° ORFS Female

DK ORFS 45

Solid one piece

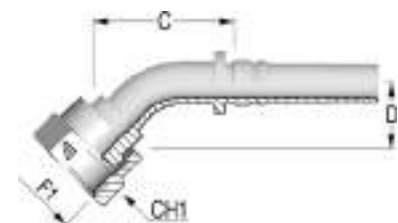

Item Code	Product Code	Nut Type	ID (Dash)	ID (mm)	ID (in)	F1 Dash	F1	C (mm)	D Drop (mm)	CH1 (mm)
1202108	H1422441-121200	Crimped	12	19,0	3/4"	12	1 3/16-12	78,0	26,0	36,0
1202109	H1422441-121600	Crimped	12	19,0	3/4"	16	1 7/16-12	68,4	28,0	41,0
1202110	H1422441-161600	Crimped	16	25,0	1"	16	1 7/16-12	114,0	28,0	41,0
1202111	H1422441-162000	Crimped	16	25,0	1"	20	1 11/16-12	83,4	28,0	50,0
1202112	H1422441-202000	Crimped	20	32,0	1 1/4"	20	1 11/16-12	100,7	33,0	50,0

// H1422491
90° ORFS Female
DK ORFS 90
Solid one piece

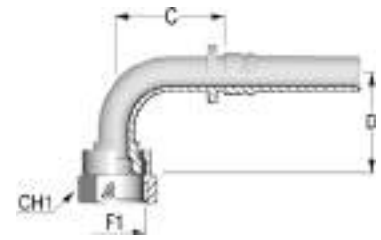

Item Code	Product Code	Nut Type	ID (Dash)	ID (mm)	ID (in)	F1 Dash	F1	C (mm)	D Drop (mm)	CH1 (mm)
1203123	H1422491-101200	Crimped	10	16,0	5/8"	12	1 3/16-12	48,1	58,0	36,0
1202117	H1422491-121200	Crimped	12	19,0	3/4"	12	1 3/16-12	64,2	58,0	36,0
1202116	H1422491-121600	Crimped	12	19,0	3/4"	16	1 7/16-12	66,2	58,0	41,0
1202115	H1422491-161600	Crimped	16	25,0	1"	16	1 7/16-12	75,2	66,0	41,0
1202114	H1422491-162000	Crimped	16	25,0	1"	20	1 11/16-12	73,2	66,0	50,0
1202113	H1422491-202000	Crimped	20	32,0	1 1/4"	20	1 11/16-12	91,7	81,0	50,0

Design and dimensions shown may be changed without prior notice

// SAE FLANGES

// H1443310

Flange SAE 3000 psi J518 Code 61
SFL

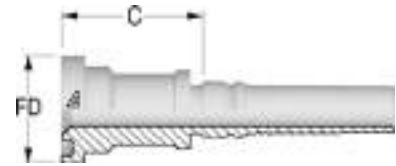

Item Code	Product Code	ID (Dash)	ID (mm)	ID (in)	F1 Dash	F1	FD (mm)	C (mm)	WP (psi)
1200233	H1443310-161600	16	25,0	1"	16	1	44,5	49,0	5000
1200234	H1443310-162000	16	25,0	1"	20	1 1/4	50,8	51,5	4000
1200257	H1443310-202000	20	32,0	1 1/4"	20	1 1/4	50,8	52,7	4000
1200256	H1443310-202400	20	32,0	1 1/4"	24	1 1/2	60,3	55,7	3000
1200276	H1443310-242400	24	38,0	1 1/2"	24	1 1/2	60,3	56,0	3000
1200277	H1443310-243200	24	38,0	1 1/2"	32	2	71,4	67,5	3000
1200287	H1443310-323200	32	51,0	2"	32	2	71,4	69,0	3000

// H1443340

45° Flange SAE 3000 psi J518 Code 61
SFL 45
Solid one piece

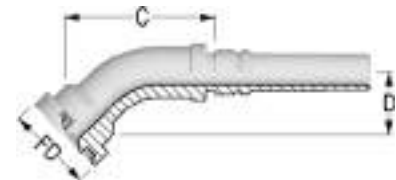

Item Code	Product Code	ID (Dash)	ID (mm)	ID (in)	F1 Dash	F1	FD (mm)	C (mm)	D Drop (mm)	WP (psi)
1200230	H1443340-162000	16	25,0	1"	20	1 1/4	50,8	95,6	30,0	4000
1200253	H1443340-202000	20	32,0	1 1/4"	20	1 1/4	50,8	100,9	32,5	4000
1200252	H1443340-202400	20	32,0	1 1/4"	24	1 1/2	60,3	92,8	40,0	3000
1200272	H1443340-242400	24	38,0	1 1/2"	24	1 1/2	60,3	103,7	43,0	3000
1200273	H1443340-243200	24	38,0	1 1/2"	32	2	71,4	132,7	56,5	3000
1200285	H1443340-323200	32	51,0	2"	32	2	71,4	138,1	54,0	3000

// H1443390

90° Flange SAE 3000 psi J518 Code 61
SFL 90
Solid one piece

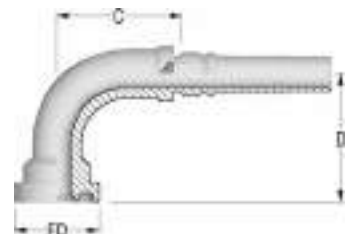

Item Code	Product Code	ID (Dash)	ID (mm)	ID (in)	F1 Dash	F1	FD (mm)	C (mm)	D Drop (mm)	WP (psi)
1200231	H1443390-161600	16	25,0	1"	16	1	44,5	72,2	64,0	5000
1200232	H1443390-162000	16	25,0	1"	20	1 1/4	50,8	70,2	69,0	4000
1200255	H1443390-202000	20	32,0	1 1/4"	20	1 1/4	50,8	86,2	81,0	4000
1200254	H1443390-202400	20	32,0	1 1/4"	24	1 1/2	60,3	81,2	85,0	3000
1200274	H1443390-242400	24	38,0	1 1/2"	24	1 1/2	60,3	96,0	93,0	3000
1200275	H1443390-243200	24	38,0	1 1/2"	32	2	71,4	130,0	97,0	3000
1200286	H1443390-323200	32	51,0	2"	32	2	71,4	134,4	130,0	3000

// H1443610

Flange SAE 6000 psi J518 Code 62
SFS

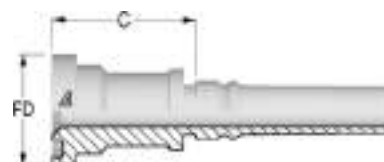

Item Code	Product Code	ID (Dash)	ID (mm)	ID (in)	F1 Dash	F1	FD (mm)	C (mm)	WP (psi)
1200199	H1443610-121200	12	19,0	3/4"	12	3/4	41,3	50,0	6000
1200198	H1443610-121600	12	19,0	3/4"	16	1	47,6	53,0	6000
1201218	H1443610-161200	16	25,0	1"	12	3/4	41,3	51,0	6000
1200224	H1443610-161600	16	25,0	1"	16	1	47,6	54,0	6000
1200225	H1443610-162000	16	25,0	1"	20	1 1/4	54,0	61,0	6000
1201556	H1443610-201600	20	32,0	1 1/4"	16	1	47,6	80,2	6000
1200246	H1443610-202000	20	32,0	1 1/4"	20	1 1/4	54,0	62,2	6000
1200245	H1443610-202400	20	32,0	1 1/4"	24	1 1/2	63,5	68,2	6000
1200270	H1443610-242000	24	38,0	1 1/2"	20	1 1/4	54,0	62,5	6000
1200268	H1443610-242400	24	38,0	1 1/2"	24	1 1/2	63,5	68,5	6000
1200271	H1443610-243200	24	38,0	1 1/2"	32	2	79,4	80,5	6000
1200284	H1443610-323200	32	51,0	2"	32	2	79,4	87,0	6000

// H1443640

45° Flange SAE 6000 psi J518 Code 62
SFS 45
Solid one piece

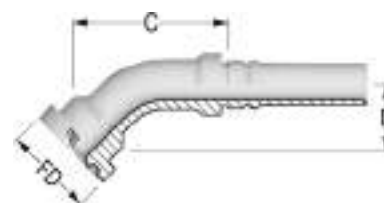

Item Code	Product Code	ID (Dash)	ID (mm)	ID (in)	F1 Dash	F1	FD (mm)	C (mm)	D Drop (mm)	WP (psi)
1200195	H1443640-121200	12	19,0	3/4"	12	3/4	41,3	72,1	30,0	6000
1200194	H1443640-121600	12	19,0	3/4"	16	1	47,6	76,8	33,0	6000
1202890	H1443640-161200	16	25,0	1"	12	3/4	41,3	80,3	29,5	6000
1200220	H1443640-161600	16	25,0	1"	16	1	47,6	94,8	35,0	6000
1200221	H1443640-162000	16	25,0	1"	20	1 1/4	54,0	105,3	44,0	6000
1201557	H1443640-201600	20	32,0	1 1/4"	16	1	47,6	104,7	34,5	6000
1200242	H1443640-202000	20	32,0	1 1/4"	20	1 1/4	54,0	102,0	39,5	6000
1200241	H1443640-202400	20	32,0	1 1/4"	24	1 1/2	63,5	111,7	48,0	6000
1200264	H1443640-242400	24	38,0	1 1/2"	24	1 1/2	63,5	136,3	48,0	6000
1200265	H1443640-243200	24	38,0	1 1/2"	32	2	79,4	129,1	55,0	6000
1200282	H1443640-323200	32	51,0	2"	32	2	79,4	160,6	63,0	6000

Design and dimensions shown may be changed without prior notice

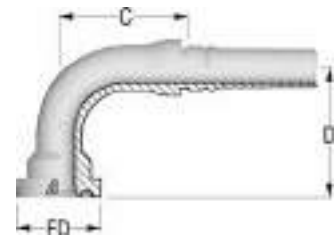
// H1443690**90° Flange SAE 6000 psi J518 Code 62****SFS 90****Solid one piece**

Item Code	Product Code	ID (Dash)	ID (mm)	ID (in)	F1 Dash	F1	FD (mm)	C (mm)	D Drop (mm)	WP (psi)
1200197	H1443690-121200	12	19,0	3/4"	12	3/4	41,3	61,2	64,0	6000
1200196	H1443690-121600	12	19,0	3/4"	16	1	47,6	61,2	66,0	6000
1202811	H1443690-161200	16	25,0	1"	12	3/4	41,3	70,2	61,0	6000
1200222	H1443690-161600	16	25,0	1"	16	1	47,6	70,4	74,0	6000
1200223	H1443690-162000	16	25,0	1"	20	1 1/4	54,0	77,2	80,0	6000
1200244	H1443690-202000	20	32,0	1 1/4"	20	1 1/4	54,0	88,2	91,0	6000
1200243	H1443690-202400	20	32,0	1 1/4"	24	1 1/2	63,5	92,9	103,5	6000
1200266	H1443690-242400	24	38,0	1 1/2"	24	1 1/2	63,5	106,3	109,0	6000
1200267	H1443690-243200	24	38,0	1 1/2"	32	2	79,4	106,5	121,5	6000
1200283	H1443690-323200	32	51,0	2"	32	2	79,4	146,0	145,0	6000

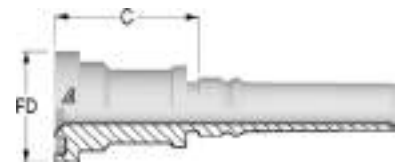
// H1T43610**Flange SAE 6000 psi J518 Code 62****SFS****Special version**

Item Code	Product Code	ID (Dash)	ID (mm)	ID (in)	F1 Dash	F1	FD (mm)	C (mm)	WP (psi)
1223166	H1T43610-322400	32	51,0	2"	24	1 1/2	63,5	106,0	6000
1223388	H1T43610-323200	32	51,0	2"	32	2	79,4	104,0	6000
1235395	H1T43610-404000	40	63,0	2 1/2"	40	2 1/2	108,0	124,3	6000

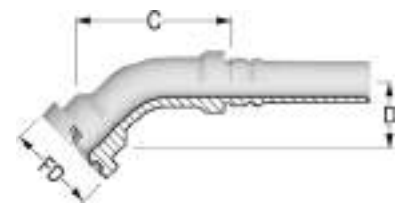
// H1T43640**45° Flange SAE 6000 psi J518 Code 62****SFS 45****Solid one piece****Special version**

Item Code	Product Code	ID (Dash)	ID (mm)	ID (in)	F1 Dash	F1	FD (mm)	C (mm)	D Drop (mm)	WP (psi)
1223389	H1T43640-323200	32	51,0	2"	32	2	79,4	141,0	63,0	6000

// H1T43690

90° Flange SAE 6000 psi J518 Code 62

SFS 90

Solid one piece

Special version

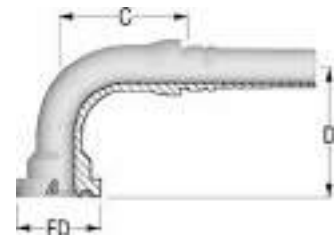

Item Code	Product Code	ID (Dash)	ID (mm)	ID (in)	F1 Dash	F1	FD (mm)	C (mm)	D Drop (mm)	WP (psi)
1223168	H1T43690-322400	32	51,0	2"	24	1 1/2	63,5	134,0	112,0	6000
1228051	H1T43690-323200	32	51,0	2"	32	2	79,4	132,0	145,0	6000

Design and dimensions shown may be changed without prior notice

// SUPERCAT FLANGES

// H1443910

Flange SUPERCAT

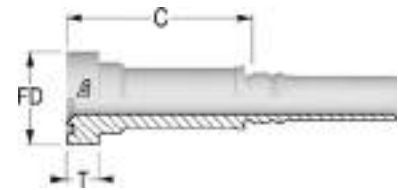

Item Code	Product Code	ID (Dash)	ID (mm)	ID (in)	F1 Dash	F1	FD (mm)	T (mm)	C (mm)
1202219	H1443910-121200	12	19,0	3/4"	12	3/4	41,3	14,3	82,0
1202388	H1443910-121600	12	19,0	3/4"	16	1	47,6	14,3	82,0
1202389	H1443910-161600	16	25,0	1"	16	1	47,6	14,3	90,0
1202390	H1443910-162000	16	25,0	1"	20	1 1/4	54,0	14,3	90,0
1202391	H1443910-202000	20	32,0	1 1/4"	20	1 1/4	54,0	14,3	86,2
1202392	H1443910-202400	20	32,0	1 1/4"	24	1 1/2	63,5	14,3	83,2

// H1443940

45° Flange SUPERCAT

Solid one piece

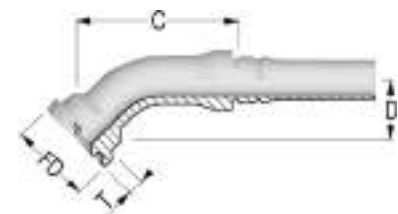

Item Code	Product Code	ID (Dash)	ID (mm)	ID (in)	F1 Dash	F1	FD (mm)	T (mm)	C (mm)	D Drop (mm)
1202398	H1443940-121200	12	19,0	3/4"	12	3/4	41,3	14,3	83,0	34,0
1202397	H1443940-121600	12	19,0	3/4"	16	1	47,6	14,3	87,4	34,0
1202396	H1443940-161600	16	25,0	1"	16	1	47,6	14,3	93,9	40,0
1202395	H1443940-162000	16	25,0	1"	20	1 1/4	54,0	14,3	95,4	40,0
1202394	H1443940-202000	20	32,0	1 1/4"	20	1 1/4	54,0	14,3	103,6	43,0
1202393	H1443940-202400	20	32,0	1 1/4"	24	1 1/2	63,5	14,3	110,1	49,5

// H1443990

90° Flange SUPERCAT

Solid one piece

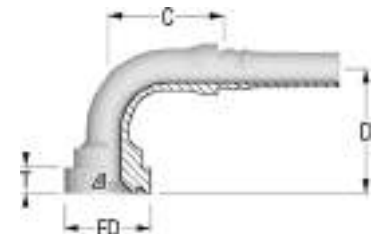

Item Code	Product Code	ID (Dash)	ID (mm)	ID (in)	F1 Dash	F1	FD (mm)	T (mm)	C (mm)	D Drop (mm)
1202399	H1443990-121200	12	19,0	3/4"	12	3/4	41,3	14,3	63,7	67,0
1202400	H1443990-121600	12	19,0	3/4"	16	1	47,6	14,3	65,2	70,0
1202401	H1443990-161600	16	25,0	1"	16	1	47,6	14,3	80,4	79,0
1202402	H1443990-162000	16	25,0	1"	20	1 1/4	54,0	14,3	75,4	82,5
1202403	H1443990-202000	20	32,0	1 1/4"	20	1 1/4	54,0	14,3	89,2	93,0
1202404	H1443990-202400	20	32,0	1 1/4"	24	1 1/2	63,5	14,3	91,4	101,0

// HAMMER UNION

// H1T13F13

Male Hammer Union Fig. 1502 Integral Fitting with Lug Nut
Special version



Item Code	Product Code	ID (Dash)	ID (mm)	ID (in)	C (mm)	L (mm)
1235624	H1T13F13-323200	32	51,0	2"	60,8	162,2

// H1T23F10

Female Hammer Union Fig. 1502 Integral Fitting with Rubber Ring
Special version

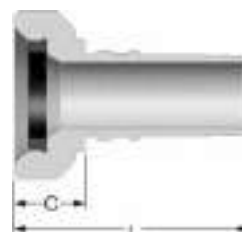

Item Code	Product Code	ID (Dash)	ID (mm)	ID (in)	C (mm)	L (mm)
1235623	H1T23F10-323200	32	51,0	2"	57,3	158,7



// ALFACRIMP C12A - ONE PIECE - FITTINGS

// BSP INSERTS.....	152	// NPSM INSERTS.....	173
// DIN METRIC INSERTS.....	156	// ORFS INSERTS.....	174
// SAE INSERTS.....	161	// JIS INSERTS.....	177
// JIC 37° INSERTS.....	164	// KOMATSU INSERTS.....	178
// NPTF INSERTS.....	171	// SAE FLANGES.....	179

// BSP INSERTS

// C12A10510

**BSPP Male 60° Flare
AGR**

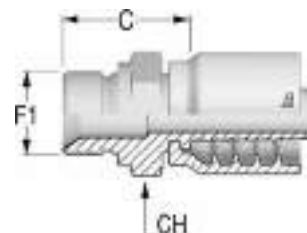

Item Code	Product Code	ID (Dash)	ID (mm)	ID (in)	F1 Dash	F1	C (mm)	CH (mm)
1232544	C12A10510-04020	4	6,0	1/4"	2	1/8-28	20,8	14,0
1232545	C12A10510-04040	4	6,0	1/4"	4	1/4-19	26,3	19,0
1232546	C12A10510-04060	4	6,0	1/4"	6	3/8-19	27,8	22,0
1232547	C12A10510-05060	5	8,0	5/16"	6	3/8-19	27,8	22,0
1232548	C12A10510-06060	6	10,0	3/8"	6	3/8-19	27,8	22,0
1232549	C12A10510-06080	6	10,0	3/8"	8	1/2-14	31,3	27,0
1232550	C12A10510-08060	8	13,0	1/2"	6	3/8-19	28,6	22,0
1232551	C12A10510-08080	8	13,0	1/2"	8	1/2-14	32,1	27,0
1232552	C12A10510-08100	8	13,0	1/2"	10	5/8-14	34,1	30,0
1232553	C12A10510-08120	8	13,0	1/2"	12	3/4-14	36,1	32,0
1232554	C12A10510-10100	10	16,0	5/8"	10	5/8-14	34,1	30,0
1232555	C12A10510-10120	10	16,0	5/8"	12	3/4-14	36,1	32,0
1232556	C12A10510-12120	12	19,0	3/4"	12	3/4-14	36,6	32,0
1232557	C12A10510-12160	12	19,0	3/4"	16	1-11	41,6	41,0
1232558	C12A10510-16160	16	25,0	1"	16	1-11	42,4	41,0
1232559	C12A10510-16200	16	25,0	1"	20	1 1/4-11	46,4	50,0

// C12A10710

**BSPT Male
AGR K**

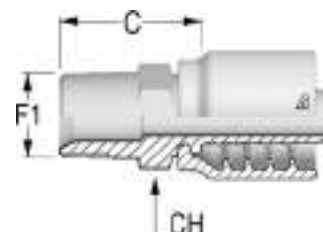

Item Code	Product Code	ID (Dash)	ID (mm)	ID (in)	F1 Dash	F1	C (mm)	CH (mm)
1232560	C12A10710-04020	4	6,0	1/4"	2	1/8-28	21,3	12,0
1232561	C12A10710-04040	4	6,0	1/4"	4	1/4-19	26,8	17,0
1232562	C12A10710-04060	4	6,0	1/4"	6	3/8-19	27,8	19,0
1232563	C12A10710-05060	5	8,0	5/16"	6	3/8-19	27,8	19,0
1232564	C12A10710-06060	6	10,0	3/8"	6	3/8-19	27,8	19,0
1232565	C12A10710-06080	6	10,0	3/8"	8	1/2-14	32,3	22,0
1232566	C12A10710-08080	8	13,0	1/2"	8	1/2-14	33,1	22,0
1232567	C12A10710-10120	10	16,0	5/8"	12	3/4-14	34,1	27,0
1232568	C12A10710-12120	12	19,0	3/4"	12	3/4-14	34,6	27,0
1232569	C12A10710-12160	12	19,0	3/4"	16	1-11	43,6	36,0
1232570	C12A10710-16160	16	25,0	1"	16	1-11	44,4	36,0

Design and dimensions shown may be changed without prior notice

// C12A20813

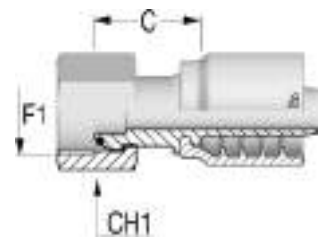
**BSPF Female 60° Cone with O-Ring
DKOR**

Item Code	Product Code	Nut Type	ID (Dash)	ID (mm)	ID (in)	F1 Dash	F1	C (mm)	CH1 (mm)
1232679	C12A20813-04040	Slip on nut	4	6,0	1/4"	4	1/4-19	20,8	19,0
1232680	C12A20813-04060	Slip on nut	4	6,0	1/4"	6	3/8-19	23,3	22,0
1232681	C12A20813-05060	Slip on nut	5	8,0	5/16"	6	3/8-19	23,3	22,0
1232675	C12A20811-06040	Crimped	6	10,0	3/8"	4	1/4-19	17,3	19,0
1232682	C12A20813-06060	Slip on nut	6	10,0	3/8"	6	3/8-19	23,3	22,0
1232683	C12A20813-06080	Slip on nut	6	10,0	3/8"	8	1/2-14	24,3	27,0
1232684	C12A20813-08080	Slip on nut	8	13,0	1/2"	8	1/2-14	25,1	27,0
1232685	C12A20813-08100	Slip on nut	8	13,0	1/2"	10	5/8-14	28,4	27,0
1232686	C12A20813-08120	Slip on nut	8	13,0	1/2"	12	3/4-14	29,0	32,0
1232676	C12A20811-10100	Crimped	10	16,0	5/8"	10	5/8-14	17,1	27,0
1232687	C12A20813-10120	Slip on nut	10	16,0	5/8"	12	3/4-14	29,0	32,0
1232677	C12A20811-12120	Crimped	12	19,0	3/4"	12	3/4-14	20,6	32,0
1232688	C12A20813-12160	Slip on nut	12	19,0	3/4"	16	1-11	34,0	38,0
1232678	C12A20811-16160	Crimped	16	25,0	1"	16	1-11	23,9	38,0
1232689	C12A20813-16200	Slip on nut	16	25,0	1"	20	1 1/4-11	39,4	50,0

Image: insert with Slip on Nut.

// C12A20843

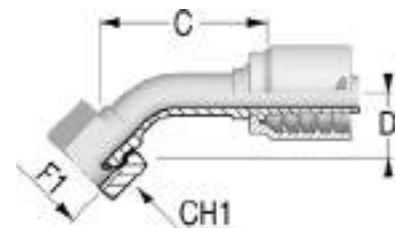
**45° BSPF Female 60° Cone with O-Ring
DKOR 45
Solid one piece**

Item Code	Product Code	Nut Type	ID (Dash)	ID (mm)	ID (in)	F1 Dash	F1	C (mm)	D Drop (mm)	CH1 (mm)
1232693	C12A20843-04040	Slip on nut	4	6,0	1/4"	4	1/4-19	45,5	15,0	19,0
1232694	C12A20843-04060	Slip on nut	4	6,0	1/4"	6	3/8-19	41,5	17,5	22,0
1232695	C12A20843-05060	Slip on nut	5	8,0	5/16"	6	3/8-19	45,1	18,5	22,0
1232696	C12A20843-06060	Slip on nut	6	10,0	3/8"	6	3/8-19	49,9	20,5	22,0
1232697	C12A20843-06080	Slip on nut	6	10,0	3/8"	8	1/2-14	45,7	21,0	27,0
1232698	C12A20843-08080	Slip on nut	8	13,0	1/2"	8	1/2-14	55,0	21,0	27,0
1232699	C12A20843-08100	Slip on nut	8	13,0	1/2"	10	5/8-14	57,2	23,0	27,0
1232700	C12A20843-08120	Slip on nut	8	13,0	1/2"	12	3/4-14	56,7	23,0	32,0
1232690	C12A20841-10100	Crimped	10	16,0	5/8"	10	5/8-14	64,0	21,5	27,0
1232701	C12A20843-10120	Slip on nut	10	16,0	5/8"	12	3/4-14	66,5	22,5	32,0
1232691	C12A20841-12120	Crimped	12	19,0	3/4"	12	3/4-14	70,0	28,0	32,0
1232702	C12A20843-12160	Slip on nut	12	19,0	3/4"	16	1-11	74,6	31,5	38,0
1232692	C12A20841-16160	Crimped	16	25,0	1"	16	1-11	84,0	34,0	38,0

Image: insert with Slip on Nut.

// C12A20893

**90° BSPP Female 60° Cone with O-Ring
DKOR 90
Solid one piece**

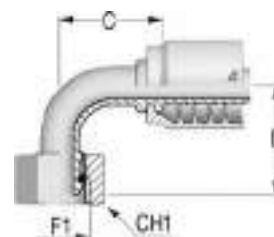

Item Code	Product Code	Nut Type	ID (Dash)	ID (mm)	ID (in)	F1 Dash	F1	C (mm)	D Drop (mm)	CH1 (mm)
1232706	C12A20893-04040	Slip on nut	4	6,0	1/4"	4	1/4-19	29,3	29,0	19,0
1232707	C12A20893-04060	Slip on nut	4	6,0	1/4"	6	3/8-19	29,8	31,0	22,0
1232708	C12A20893-05060	Slip on nut	5	8,0	5/16"	6	3/8-19	33,2	36,0	22,0
1232709	C12A20893-06060	Slip on nut	6	10,0	3/8"	6	3/8-19	34,8	42,0	22,0
1232710	C12A20893-06080	Slip on nut	6	10,0	3/8"	8	1/2-14	34,3	35,5	27,0
1232711	C12A20893-08080	Slip on nut	8	13,0	1/2"	8	1/2-14	35,8	41,0	27,0
1232712	C12A20893-08100	Slip on nut	8	13,0	1/2"	10	5/8-14	41,6	43,5	27,0
1232713	C12A20893-08120	Slip on nut	8	13,0	1/2"	12	3/4-14	41,8	43,0	32,0
1232703	C12A20891-10100	Crimped	10	16,0	5/8"	10	5/8-14	47,9	47,0	27,0
1232714	C12A20893-10120	Slip on nut	10	16,0	5/8"	12	3/4-14	51,9	49,0	32,0
1232704	C12A20891-12120	Crimped	12	19,0	3/4"	12	3/4-14	49,1	53,0	32,0
1232715	C12A20893-12160	Slip on nut	12	19,0	3/4"	16	1-11	54,1	60,5	38,0
1232705	C12A20891-16160	Crimped	16	25,0	1"	16	1-11	75,1	69,0	38,0
1232716	C12A20893-16200	Slip on nut	16	25,0	1"	20	1 1/4-11	75,1	88,5	50,0

Image: insert with Slip on Nut.

// C12A20581

**90° Compact BSPP Female 60° Cone
DKR 90**

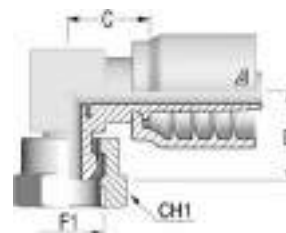

Item Code	Product Code	Nut Type	ID (Dash)	ID (mm)	ID (in)	F1 Dash	F1	C (mm)	D Drop (mm)	CH1 (mm)
1232668	C12A20581-06060	Crimped	6	10,0	3/8"	6	3/8-19	18,8	22,0	22,0
1232669	C12A20581-08080	Crimped	8	13,0	1/2"	8	1/2-14	22,6	24,5	27,0
1232670	C12A20581-12120	Crimped	12	19,0	3/4"	12	3/4-14	26,7	31,0	32,0

Design and dimensions shown may be changed without prior notice

// C12A20613

BSPF Female Flat Seat

DKR FD

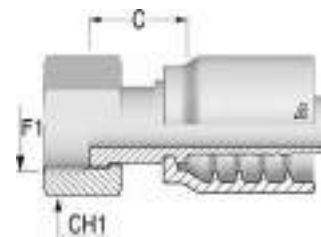

Item Code	Product Code	Nut Type	ID (Dash)	ID (mm)	ID (in)	F1 Dash	F1	C (mm)	CH1 (mm)
1232672	C12A20613-06060	Slip on nut	6	10,0	3/8"	6	3/8-19	20,3	22,0
1232673	C12A20613-06080	Slip on nut	6	10,0	3/8"	8	1/2-14	20,8	27,0
1232674	C12A20613-08080	Slip on nut	8	13,0	1/2"	8	1/2-14	21,6	27,0
1232671	C12A20611-12120	Crimped	12	19,0	3/4"	12	3/4-14	18,1	32,0

Image: insert with Slip on Nut.

// DIN METRIC INSERTS

// C12A11110

Metric Male 24° Seat
DIN 3853 - Light Series
CEL

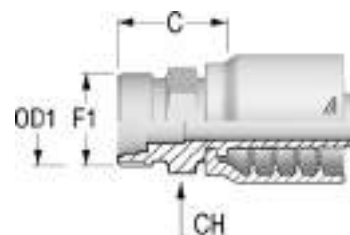

Item Code	Product Code	ID (Dash)	ID (mm)	ID (in)	F1	OD1	C (mm)	CH (mm)
1232573	C12A11110-04160	4	6,0	1/4"	M16X1.5	10	23,3	17,0
1232571	C12A11110-04120	4	6,0	1/4"	M12X1.5	6	21,3	14,0
1232572	C12A11110-04140	4	6,0	1/4"	M14X1.5	8	21,3	14,0
1232575	C12A11110-05180	5	8,0	5/16"	M18X1.5	12	24,3	19,0
1232574	C12A11110-05160	5	8,0	5/16"	M16X1.5	10	23,3	17,0
1232577	C12A11110-06180	6	10,0	3/8"	M18X1.5	12	24,3	19,0
1232578	C12A11110-06220	6	10,0	3/8"	M22X1.5	15	25,3	22,0
1232576	C12A11110-06160	6	10,0	3/8"	M16X1.5	10	23,3	17,0
1232579	C12A11110-08220	8	13,0	1/2"	M22X1.5	15	26,1	22,0
1232580	C12A11110-08260	8	13,0	1/2"	M26X1.5	18	27,1	27,0
1232581	C12A11110-10260	10	16,0	5/8"	M26X1.5	18	27,1	27,0
1232582	C12A11110-12300	12	19,0	3/4"	M30X2	22	31,6	32,0
1232583	C12A11110-16360	16	25,0	1"	M36X2	28	34,4	36,0

// C12A21513

Metric Female 24° Cone with O-Ring
ISO 8434-1 - Light Series
DKOL

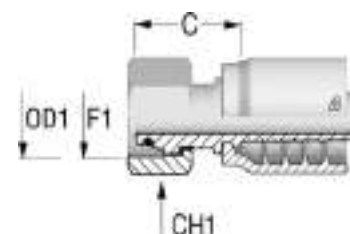

Item Code	Product Code	Nut Type	ID (Dash)	ID (mm)	ID (in)	F1	OD1	C (mm)	CH1 (mm)
1232717	C12A21511-04120	Crimped	4	6,0	1/4"	M12X1.5	6	24,8	14,0
1232718	C12A21513-04140	Slip on nut	4	6,0	1/4"	M14X1.5	8	24,4	17,0
1232719	C12A21513-04160	Slip on nut	4	6,0	1/4"	M16X1.5	10	25,4	19,0
1232720	C12A21513-05160	Slip on nut	5	8,0	5/16"	M16X1.5	10	25,4	19,0
1232722	C12A21513-06180	Slip on nut	6	10,0	3/8"	M18X1.5	12	25,4	22,0
1232723	C12A21513-06220	Slip on nut	6	10,0	3/8"	M22X1.5	15	27,4	27,0
1232724	C12A21513-08220	Slip on nut	8	13,0	1/2"	M22X1.5	15	28,2	27,0
1232725	C12A21513-08260	Slip on nut	8	13,0	1/2"	M26X1.5	18	29,2	32,0
1232726	C12A21513-10260	Slip on nut	10	16,0	5/8"	M26X1.5	18	29,2	32,0
1232727	C12A21513-12300	Slip on nut	12	19,0	3/4"	M30X2	22	31,7	36,0
1232728	C12A21513-16360	Slip on nut	16	25,0	1"	M36X2	28	33,6	41,0

Image: insert with Slip on Nut.

Design and dimensions shown may be changed without prior notice

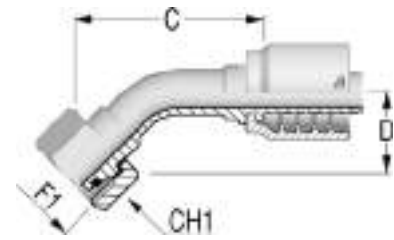
// C12A21543**45° Metric Female 24° Cone with O-Ring****ISO 8434-1 - Light Series****DKOL 45****Solid one piece**

Item Code	Product Code	Nut Type	ID (Dash)	ID (mm)	ID (in)	F1	OD1	C (mm)	D Drop (mm)	CH1 (mm)
1232729	C12A21543-04140	Slip on nut	4	6,0	1/4"	M14X1.5	8	43,0	17,5	17,0
1232730	C12A21543-04160	Slip on nut	4	6,0	1/4"	M16X1.5	10	42,0	20,0	19,0
1232731	C12A21543-05160	Slip on nut	5	8,0	5/16"	M16X1.5	10	47,5	20,0	19,0
1232733	C12A21543-06180	Slip on nut	6	10,0	3/8"	M18X1.5	12	46,8	19,5	22,0
1232734	C12A21543-08220	Slip on nut	8	13,0	1/2"	M22X1.5	15	55,0	21,0	22,0
1232735	C12A21543-10260	Slip on nut	10	16,0	5/8"	M26X1.5	18	65,3	24,0	32,0
1232736	C12A21543-12300	Slip on nut	12	19,0	3/4"	M30X2	22	69,4	32,0	36,0
1232737	C12A21543-16360	Slip on nut	16	25,0	1"	M36X2	28	91,4	32,0	41,0

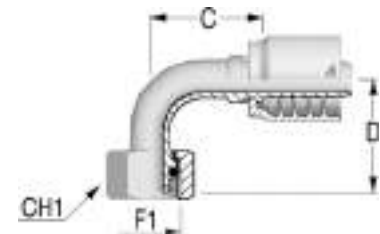
// C12A21593**90° Metric Female 24° Cone with O-Ring****ISO 8434-1 - Light Series****DKOL 90****Solid one piece**

Item Code	Product Code	Nut Type	ID (Dash)	ID (mm)	ID (in)	F1	OD1	C (mm)	D Drop (mm)	CH1 (mm)
1232738	C12A21591-04120	Crimped	4	6,0	1/4"	M12X1.5	6	29,5	26,0	14,0
1232739	C12A21593-04140	Slip on nut	4	6,0	1/4"	M14X1.5	8	28,3	32,5	17,0
1232740	C12A21593-04160	Slip on nut	4	6,0	1/4"	M16X1.5	10	28,3	32,5	19,0
1232741	C12A21593-04180	Slip on nut	4	6,0	1/4"	M18X1.5	12	28,8	35,0	22,0
1232742	C12A21593-05160	Slip on nut	5	8,0	5/16"	M16X1.5	10	33,7	38,0	19,0
1232744	C12A21593-06180	Slip on nut	6	10,0	3/8"	M18X1.5	12	32,8	39,0	22,0
1232745	C12A21593-08220	Slip on nut	8	13,0	1/2"	M22X1.5	15	39,8	40,5	27,0
1232746	C12A21593-10260	Slip on nut	10	16,0	5/8"	M26X1.5	18	51,4	48,0	32,0
1232747	C12A21593-10300	Slip on nut	10	16,0	5/8"	M30X2	22	52,4	49,0	36,0
1232748	C12A21593-12300	Slip on nut	12	19,0	3/4"	M30X2	22	52,1	59,0	36,0
1232749	C12A21593-16360	Slip on nut	16	25,0	1"	M36X2	28	77,6	68,0	41,0

Image: insert with Slip on Nut.

// C12A11210

**Metric Male 24° Seat
DIN 3853 - Heavy Series
CES**

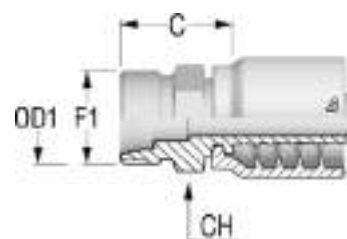

Item Code	Product Code	ID (Dash)	ID (mm)	ID (in)	F1	OD1	C (mm)	CH (mm)
1232584	C12A11210-04180	4	6,0	1/4"	M18X1.5	10	25,3	19,0
1232585	C12A11210-05200	5	8,0	5/16"	M20X1.5	12	25,3	22,0
1232586	C12A11210-06200	6	10,0	3/8"	M20X1.5	12	25,3	22,0
1232587	C12A11210-06220	6	10,0	3/8"	M22X1.5	14	27,3	22,0
1232588	C12A11210-08240	8	13,0	1/2"	M24X1.5	16	29,1	24,0
1232589	C12A11210-10300	10	16,0	5/8"	M30X2	20	33,1	32,0
1232590	C12A11210-12300	12	19,0	3/4"	M30X2	20	33,6	32,0
1232591	C12A11210-12360	12	19,0	3/4"	M36X2	25	37,6	36,0
1232592	C12A11210-16420	16	25,0	1"	M42X2	30	42,4	46,0

// C12A21613

**Metric Female 24° Cone with O-Ring
ISO 8434-1 - Heavy Series
DKOS**

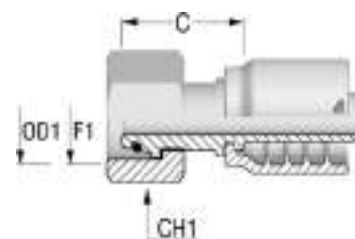

Item Code	Product Code	Nut Type	ID (Dash)	ID (mm)	ID (in)	F1	OD1	C (mm)	CH1 (mm)
1232750	C12A21613-04160	Slip on nut	4	6,0	1/4"	M16X1.5	8	27,7	19,0
1232751	C12A21613-04180	Slip on nut	4	6,0	1/4"	M18X1.5	10	27,6	22,0
1232752	C12A21613-05200	Slip on nut	5	8,0	5/16"	M20X1.5	12	27,6	24,0
1232754	C12A21613-06200	Slip on nut	6	10,0	3/8"	M20X1.5	12	27,6	24,0
1232755	C12A21613-06220	Slip on nut	6	10,0	3/8"	M22X1.5	14	31,1	27,0
1232757	C12A21613-08240	Slip on nut	8	13,0	1/2"	M24X1.5	16	31,7	30,0
1232758	C12A21613-10300	Slip on nut	10	16,0	5/8"	M30X2	20	36,5	36,0
1232759	C12A21613-12300	Slip on nut	12	19,0	3/4"	M30X2	20	37,0	36,0
1232760	C12A21613-12360	Slip on nut	12	19,0	3/4"	M36X2	25	40,2	46,0
1232761	C12A21613-16360	Slip on nut	16	25,0	1"	M36X2	25	41,0	46,0
1232762	C12A21613-16420	Slip on nut	16	25,0	1"	M42X2	30	43,1	50,0

Design and dimensions shown may be changed without prior notice

// C12A21643

45° Metric Female 24° Cone with O-Ring

ISO 8434-1 - Heavy Series

DKOS 45

Solid one piece

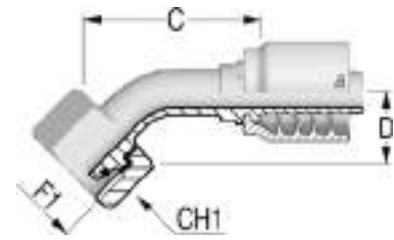

Item Code	Product Code	Nut Type	ID (Dash)	ID (mm)	ID (in)	F1	OD1	C (mm)	D Drop (mm)	CH1 (mm)
1232763	C12A21643-04160	Slip on nut	4	6,0	1/4"	M16X1.5	8	48,6	16,0	19,0
1232764	C12A21643-04180	Slip on nut	4	6,0	1/4"	M18X1.5	10	43,5	19,0	22,0
1232765	C12A21643-05200	Slip on nut	5	8,0	5/16"	M20X1.5	12	48,1	21,0	24,0
1232766	C12A21643-06200	Slip on nut	6	10,0	3/8"	M20X1.5	12	50,6	20,0	24,0
1232767	C12A21643-06220	Slip on nut	6	10,0	3/8"	M22X1.5	14	52,9	21,0	27,0
1232768	C12A21643-08240	Slip on nut	8	13,0	1/2"	M24X1.5	16	55,8	21,5	30,0
1232769	C12A21643-10300	Slip on nut	10	16,0	5/8"	M30X2	20	66,3	30,0	36,0
1232770	C12A21643-12360	Slip on nut	12	19,0	3/4"	M36X2	25	69,5	33,0	46,0
1232771	C12A21643-16420	Slip on nut	16	25,0	1"	M42X2	30	110,3	40,5	50,0

// C12A21693

90° Metric Female 24° Cone with O-Ring

ISO 8434-1 - Heavy Series

DKOS 90

Solid one piece

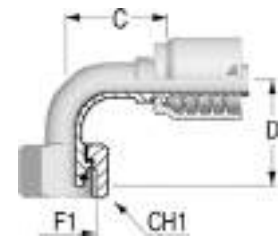

Item Code	Product Code	Nut Type	ID (Dash)	ID (mm)	ID (in)	F1	OD1	C (mm)	D Drop (mm)	CH1 (mm)
1232772	C12A21693-04160	Slip on nut	4	6,0	1/4"	M16X1.5	8	27,3	33,0	19,0
1232773	C12A21693-04180	Slip on nut	4	6,0	1/4"	M18X1.5	10	26,8	34,0	22,0
1232774	C12A21693-05200	Slip on nut	5	8,0	5/16"	M20X1.5	12	33,2	39,0	24,0
1232775	C12A21692-06180	Thrust wire nut	6	10,0	3/8"	M18X1.5	10	35,0	38,0	22,0
1232776	C12A21693-06200	Slip on nut	6	10,0	3/8"	M20X1.5	12	34,3	38,5	24,0
1232777	C12A21693-06220	Slip on nut	6	10,0	3/8"	M22X1.5	14	34,3	40,5	27,0
1232778	C12A21693-08240	Slip on nut	8	13,0	1/2"	M24X1.5	16	39,8	41,5	30,0
1232779	C12A21693-10300	Slip on nut	10	16,0	5/8"	M30X2	20	47,9	55,0	36,0
1232780	C12A21693-12300	Slip on nut	12	19,0	3/4"	M30X2	20	50,6	58,0	36,0
1232781	C12A21693-12360	Slip on nut	12	19,0	3/4"	M36X2	25	50,6	59,5	46,0
1232782	C12A21693-16420	Slip on nut	16	25,0	1"	M42X2	30	75,6	79,0	50,0

Image: insert with Slip on Nut.

// C12A52010

Metric Straight Standpipe

DIN 2353

RSL/RSS

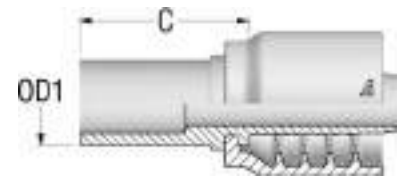

Item Code	Product Code	ID (Dash)	ID (mm)	ID (in)	OD1	C (mm)
1233002	C12A52010-04080	4	6,0	1/4"	8	30,2
1233003	C12A52010-06100	6	10,0	3/8"	10	30,3
1233004	C12A52010-08150	8	13,0	1/2"	15	32,1
1233005	C12A52010-08160	8	13,0	1/2"	16	37,1

Design and dimensions shown may be changed without prior notice

// SAE INSERTS

// C12A13B10

SAE Male Flareless

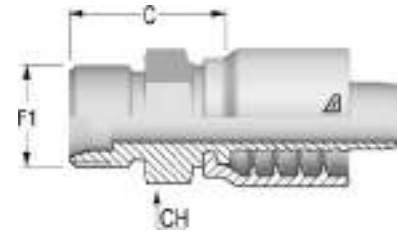

Item Code	Product Code	ID (Dash)	ID (mm)	ID (in)	F1 Dash	F1	C (mm)	CH (mm)
1240072	C12A13B10-04040	4	6,0	1/4"	4	7/16-20	21,8	12,0
1242131	C12A13B10-05060	5	8,0	5/16"	6	9/16-18	24,2	16,0
1239967	C12A13B10-06060	6	10,0	3/8"	6	9/16-18	24,2	16,0
1242132	C12A13B10-06080	6	10,0	3/8"	8	3/4-16	27,6	22,0
1237777	C12A13B10-08080	8	13,0	1/2"	8	3/4-16	28,4	22,0
1242133	C12A13B10-12120	12	19,0	3/4"	12	1 1/16-12	33,1	30,0
1242135	C12A13B10-16160	16	25,0	1"	16	1 5/16-12	37,9	36,0

// C12A26611

SAE Female Swivel 45° Seat

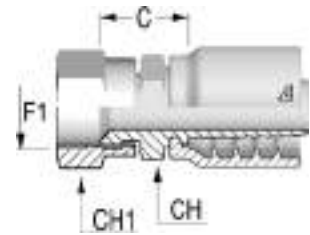

Item Code	Product Code	Nut Type	ID (Dash)	ID (mm)	ID (in)	F1 Dash	F1	C (mm)	CH (mm)	CH1 (mm)
1232955	C12A26611-06060	Crimped	6	10,0	3/8"	6	5/8-18	23,3	19,0	22,0
1232956	C12A26611-12120	Crimped	12	19,0	3/4"	12	1 1/16-14	28,6	27,0	32,0

// C12A13010

SAE Male Solid - O-Ring Boss

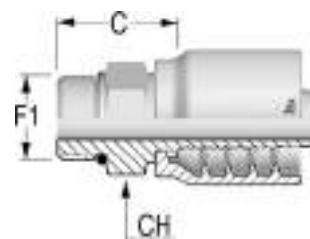

Item Code	Product Code	ID (Dash)	ID (mm)	ID (in)	F1 Dash	F1	C (mm)	CH (mm)
1232654	C12A13010-04040	4	6,0	1/4"	4	7/16-20	20,3	14,0
1232655	C12A13010-04050	4	6,0	1/4"	5	1/2-20	21,3	16,0
1232656	C12A13010-04060	4	6,0	1/4"	6	9/16-18	22,3	17,0
1232657	C12A13010-06060	6	10,0	3/8"	6	9/16-18	23,3	19,0
1232658	C12A13010-06080	6	10,0	3/8"	8	3/4-16	24,3	22,0
1232659	C12A13010-06100	6	10,0	3/8"	10	7/8-14	26,8	27,0
1232660	C12A13010-08080	8	13,0	1/2"	8	3/4-16	25,1	22,0
1232661	C12A13010-08100	8	13,0	1/2"	10	7/8-14	27,6	27,0
1232662	C12A13010-08120	8	13,0	1/2"	12	1 1/16-12	32,1	32,0
1232663	C12A13010-10120	10	16,0	5/8"	12	1 1/16-12	32,1	32,0
1232664	C12A13010-12100	12	19,0	3/4"	10	7/8-14	28,1	27,0
1232665	C12A13010-12120	12	19,0	3/4"	12	1 1/16-12	32,6	32,0
1232666	C12A13010-12160	12	19,0	3/4"	16	1 5/16-12	34,6	38,0
1232667	C12A13010-16160	16	25,0	1"	16	1 5/16-12	35,4	38,0

// C12A13011

SAE Male Swivel O-Ring Boss

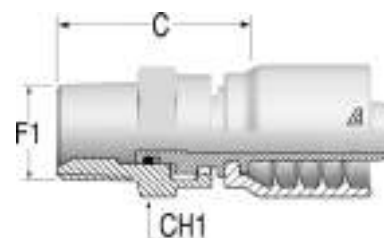

Item Code	Product Code	Nut Type	ID (Dash)	ID (mm)	ID (in)	F1 Dash	F1	C (mm)	CH (mm)
1240619	C12A13011-04040	Crimped	4	6,0	1/4"	4	7/16-20	33,1	17,0
1240621	C12A13011-04060	Crimped	4	6,0	1/4"	4	7/16-20	42,5	22,0
1240622	C12A13011-06060	Crimped	6	10,0	3/8"	6	9/16-18	40,5	22,0
1240623	C12A13011-06080	Crimped	6	10,0	3/8"	8	3/4-16	43,5	25,0
1240624	C12A13011-08080	Crimped	8	13,0	1/2"	8	3/4-16	42,3	25,0
1240625	C12A13011-08100	Crimped	8	13,0	1/2"	8	3/4-16	43,8	25,0
1240626	C12A13011-12120	Crimped	12	19,0	3/4"	12	1 1/16-12	49,6	32,0
1240627	C12A13011-16160	Crimped	16	25,0	1"	16	1 5/16-12	53,9	41,0

Design and dimensions shown may be changed without prior notice

// C12A13081

90° Compact SAE Male Swivel - O-Ring Boss

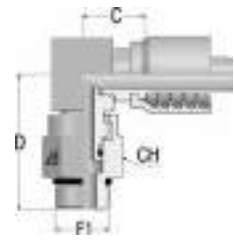

Item Code	Product Code	Nut Type	ID (Dash)	ID (mm)	ID (in)	F1 Dash	F1	C (mm)	D Drop (mm)	CH (mm)
1240611	C12A13081-04040	Crimped	4	6,0	1/4"	4	7/16-20	17,0	35,0	17,0
1240612	C12A13081-04050	Crimped	4	6,0	1/4"	5	1/2-20	17,0	35,0	17,0
1240613	C12A13081-04060	Crimped	4	6,0	1/4"	6	9/16-18	19,0	42,0	22,0
1240614	C12A13081-06060	Crimped	6	10,0	3/8"	6	9/16-18	20,0	44,0	22,0
1240615	C12A13081-06080	Crimped	6	10,0	3/8"	8	3/4-16	22,0	45,0	25,0
1240616	C12A13081-08080	Crimped	8	13,0	1/2"	8	3/4-16	23,0	48,0	25,0
1240001	C12A13081-08100	Crimped	8	13,0	1/2"	10	7/8-14	23,0	50,0	25,0
1240617	C12A13081-12120	Crimped	12	19,0	3/4"	12	1 1/16-12	27,0	60,0	32,0
1240618	C12A13081-16160	Crimped	16	25,0	1"	16	1 5/16-12	33,4	67,5	41,0

// JIC 37° INSERTS

// C12A12510

JIC Male 37° Cone

AGJ

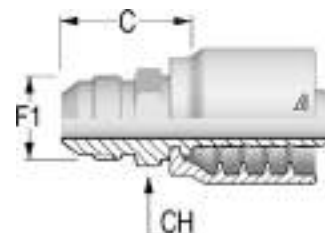

Item Code	Product Code	ID (Dash)	ID (mm)	ID (in)	F1 Dash	F1	C (mm)	CH (mm)
1232606	C12A12510-04040	4	6,0	1/4"	4	7/16-20	25,3	12,0
1232607	C12A12510-04050	4	6,0	1/4"	5	1/2-20	25,3	14,0
1232608	C12A12510-04060	4	6,0	1/4"	6	9/16-18	26,3	17,0
1232609	C12A12510-05050	5	8,0	5/16"	5	1/2-20	25,3	14,0
1232610	C12A12510-05060	5	8,0	5/16"	6	9/16-18	26,3	17,0
1232611	C12A12510-06060	6	10,0	3/8"	6	9/16-18	26,3	17,0
1232612	C12A12510-06080	6	10,0	3/8"	8	3/4-16	29,8	19,0
1232613	C12A12510-06100	6	10,0	3/8"	10	7/8-14	33,8	24,0
1232614	C12A12510-08080	8	13,0	1/2"	8	3/4-16	30,6	19,0
1232615	C12A12510-08100	8	13,0	1/2"	10	7/8-14	34,6	24,0
1232616	C12A12510-08120	8	13,0	1/2"	12	1 1/16-12	37,1	27,0
1232617	C12A12510-10100	10	16,0	5/8"	10	7/8-14	34,6	24,0
1232618	C12A12510-10120	10	16,0	5/8"	12	1 1/16-12	37,1	27,0
1232619	C12A12510-12120	12	19,0	3/4"	12	1 1/16-12	37,6	27,0
1232620	C12A12510-12140	12	19,0	3/4"	14	1 3/16-12	40,1	32,0
1232621	C12A12510-12160	12	19,0	3/4"	16	1 5/16-12	42,6	36,0
1232622	C12A12510-16160	16	25,0	1"	16	1 5/16-12	43,4	36,0
1232623	C12A12510-16200	16	25,0	1"	20	1 5/8-12	46,9	46,0

Design and dimensions shown may be changed without prior notice

// C12A22511

JIC Female 37° Seat

DKJ

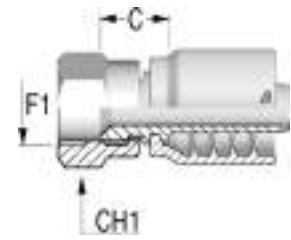

Item Code	Product Code	Nut Type	ID (Dash)	ID (mm)	ID (in)	F1 Dash	F1	C (mm)	CH1 (mm)
1232848	C12A22511-04040	Crimped	4	6,0	1/4"	4	7/16-20	14,6	16,0
1232849	C12A22511-04050	Crimped	4	6,0	1/4"	5	1/2-20	15,3	17,0
1232850	C12A22511-04060	Crimped	4	6,0	1/4"	6	9/16-18	15,3	19,0
1232851	C12A22511-05050	Crimped	5	8,0	5/16"	5	1/2-20	15,3	17,0
1232852	C12A22511-05060	Crimped	5	8,0	5/16"	6	9/16-18	15,3	19,0
1232853	C12A22511-06060	Crimped	6	10,0	3/8"	6	9/16-18	15,3	19,0
1232854	C12A22511-06080	Crimped	6	10,0	3/8"	8	3/4-16	17,8	25,0
1232855	C12A22511-08080	Crimped	8	13,0	1/2"	8	3/4-16	18,6	25,0
1232856	C12A22511-08100	Crimped	8	13,0	1/2"	10	7/8-14	19,6	27,0
1232857	C12A22511-08120	Crimped	8	13,0	1/2"	12	1 1/16-12	22,1	32,0
1232858	C12A22511-10100	Crimped	10	16,0	5/8"	10	7/8-14	19,6	27,0
1232859	C12A22511-10120	Crimped	10	16,0	5/8"	12	1 1/16-12	20,1	32,0
1232860	C12A22511-12100	Crimped	12	19,0	3/4"	10	7/8-14	20,1	27,0
1232861	C12A22511-12120	Crimped	12	19,0	3/4"	12	1 1/16-12	20,6	32,0
1232862	C12A22511-12140	Crimped	12	19,0	3/4"	14	1 3/16-12	19,9	36,0
1232863	C12A22511-12160	Crimped	12	19,0	3/4"	16	1 5/16-12	22,1	38,0
1232864	C12A22511-16160	Crimped	16	25,0	1"	16	1 5/16-12	23,9	38,0
1232865	C12A22512-16200	Thrust wire nut	16	25,0	1"	20	1 5/8-12	26,5	50,0

Image: insert with Crimped Nut.

// C12A26511

**JIC Female 37° Seat with Stem Hexagon
DKJ**

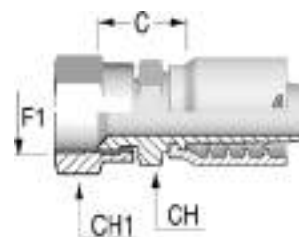

Item Code	Product Code	Nut Type	ID (Dash)	ID (mm)	ID (in)	F1 Dash	F1	C (mm)	CH (mm)	CH1 (mm)
1232933	C12A26511-04040	Crimped	4	6,0	1/4"	4	7/16-20	19,6	14,0	16,0
1232934	C12A26511-04050	Crimped	4	6,0	1/4"	5	1/2-20	20,3	14,0	17,0
1232935	C12A26511-04060	Crimped	4	6,0	1/4"	6	9/16-18	20,3	14,0	19,0
1232936	C12A26511-05060	Crimped	5	8,0	5/16"	6	9/16-18	20,3	14,0	19,0
1232937	C12A26511-06040	Crimped	6	10,0	3/8"	4	7/16-20	20,6	17,0	16,0
1232938	C12A26511-06060	Crimped	6	10,0	3/8"	6	9/16-18	21,3	17,0	19,0
1232939	C12A26511-06080	Crimped	6	10,0	3/8"	8	3/4-16	24,8	19,0	25,0
1232940	C12A26511-06100	Crimped	6	10,0	3/8"	10	7/8-14	25,8	22,0	27,0
1232941	C12A26511-08060	Crimped	8	13,0	1/2"	6	9/16-18	23,1	19,0	19,0
1232942	C12A26511-08080	Crimped	8	13,0	1/2"	8	3/4-16	25,6	19,0	25,0
1232944	C12A26511-08120	Crimped	8	13,0	1/2"	12	1 1/16-12	28,1	25,0	32,0
1232945	C12A26511-10080	Crimped	10	16,0	5/8"	8	3/4-16	26,6	24,0	25,0
1232946	C12A26511-10100	Crimped	10	16,0	5/8"	10	7/8-14	27,6	24,0	27,0
1232947	C12A26511-10120	Crimped	10	16,0	5/8"	12	1 1/16-12	28,1	25,0	32,0
1232948	C12A26511-12100	Crimped	12	19,0	3/4"	10	7/8-14	28,1	27,0	27,0
1232949	C12A26511-12120	Crimped	12	19,0	3/4"	12	1 1/16-12	28,6	27,0	32,0
1232950	C12A26511-12140	Crimped	12	19,0	3/4"	14	1 3/16-12	29,9	32,0	36,0
1232951	C12A26511-12160	Crimped	12	19,0	3/4"	16	1 5/16-12	32,1	32,0	38,0
1232952	C12A26511-16120	Crimped	16	25,0	1"	12	1 1/16-12	31,4	32,0	32,0
1232953	C12A26511-16160	Crimped	16	25,0	1"	16	1 5/16-12	32,9	32,0	38,0
1232954	C12A26512-16200	Thrust wire nut	16	25,0	1"	20	1 5/8-12	37,5	41,0	50,0

Image: insert with Crimped Nut.

// C12A26514 NEW

**JIC Female 37° Seat with double Hexagon
DKJ and solid nut**

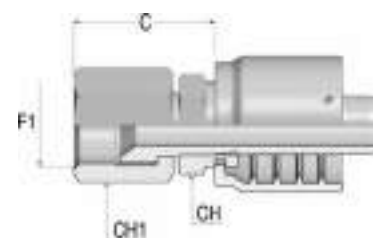

Item Code	Product Code	Nut Type	ID (Dash)	ID (mm)	ID (in)	F1 Dash	F1	C (mm)	CH (mm)	CH1 (mm)
1251034	C12A26514-04040	Slip on nut	4	6,0	1/4"	4	7/16-20	19,0	14,0	14,0
1251035	C12A26514-04050	Slip on nut	4	6,0	1/4"	5	1/2-20	19,0	14,0	17,0
1251036	C12A2651K-04060	Slip on nut	4	6,0	1/4"	6	9/16-18	22,0	14,0	19,0
1251037	C12A26514-05060	Slip on nut	5	8,0	5/16"	6	9/16-18	22,0	14,0	19,0
1251038	C12A26514-06060	Slip on nut	6	10,0	3/8"	6	9/16-18	22,0	17,0	19,0
1251583	C12A2651K-06080	Slip on nut	6	10,0	3/8"	8	3/4-16	28,3	17,0	22,0
1250047	C12A26514-08080	Slip on nut	8	13,0	1/2"	8	3/4-16	25,7	19,0	22,0
1249628	C12A2651K-08100	Slip on nut	8	13,0	1/2"	10	7/8-14	29,0	22,0	27,0
1251039	C12A26514-10100	Slip on nut	10	16,0	5/8"	10	7/8-14	29,2	24,0	27,0
1249959	C12A2651K-10120	Crimped	10	16,0	5/8"	12	1 1/16-12	28,6	24,0	32,0
1249637	C12A26514-12120	Slip on nut	12	19,0	3/4"	12	1 1/16-12	29,7	27,0	32,0
1249721	C12A2651K-12160	Slip on nut	12	19,0	3/4"	16	1 5/16-12	36,1	32,0	38,0
1249818	C12A26514-16160	Slip on nut	16	25,0	1"	16	1 5/16-12	32,9	32,0	41,0

Product Codes roots ending with K: insert with double hexagon knurled (ex. C12A2651K).

Design and dimensions shown may be changed without prior notice

// C12A22541-M

45° JIC Female 37° Seat

Medium Drop

DKJ 45M

Solid one piece

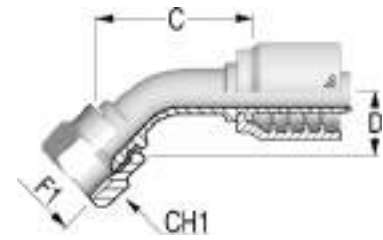

Item Code	Product Code	Nut Type	ID (Dash)	ID (mm)	ID (in)	F1 Dash	F1	C (mm)	D Drop (mm)	CH1 (mm)
1232866	C12A22541-0404M	Crimped	4	6,0	1/4"	4	7/16-20	36,6	10,0	16,0
1232867	C12A22541-0405M	Crimped	4	6,0	1/4"	5	1/2-20	37,2	12,0	17,0
1232868	C12A22541-0406M	Crimped	4	6,0	1/4"	6	9/16-18	39,4	11,0	19,0
1232869	C12A22541-0506M	Crimped	5	8,0	5/16"	6	9/16-18	42,8	12,0	19,0
1232870	C12A22541-0606M	Crimped	6	10,0	3/8"	6	9/16-18	46,3	11,0	19,0
1232871	C12A22541-0608M	Crimped	6	10,0	3/8"	8	3/4-16	47,2	15,0	25,0
1232872	C12A22541-0808M	Crimped	8	13,0	1/2"	8	3/4-16	51,6	15,0	25,0
1232873	C12A22541-0810M	Crimped	8	13,0	1/2"	10	7/8-14	50,7	16,0	27,0
1232874	C12A22541-0812M	Crimped	8	13,0	1/2"	12	1 1/16-12	57,0	21,0	32,0
1232875	C12A22541-1010M	Crimped	10	16,0	5/8"	10	7/8-14	62,2	19,0	27,0
1232876	C12A22541-1012M	Crimped	10	16,0	5/8"	12	1 1/16-12	68,6	21,0	32,0
1232877	C12A22541-1212M	Crimped	12	19,0	3/4"	12	1 1/16-12	67,5	21,0	32,0
1232878	C12A22541-1216M	Crimped	12	19,0	3/4"	16	1 5/16-12	71,4	26,0	38,0
1232879	C12A22541-1616M	Crimped	16	25,0	1"	16	1 5/16-12	79,4	24,0	38,0
1232880	C12A22542-1620M	Thrust wire nut	16	25,0	1"	20	1 5/8-12	83,8	37,0	50,0

Image: insert with Crimped Nut.

// C12A26544-M **NEW**

45° JIC Female 37° Seat

Medium Drop

DKJ 45M

Solid nut and double Hexagon crimped

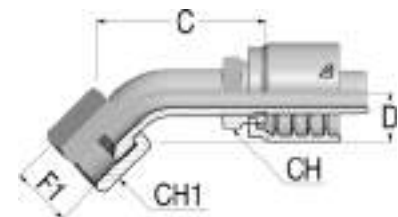

Item Code	Product Code	Nut Type	ID (Dash)	ID (mm)	ID (in)	F1 Dash	F1	C (mm)	D Drop (mm)	CH (mm)	CH1 (mm)
1253028	C12A26544-0404M	Slip on nut	4	6,0	1/4"	4	7/16-20	37,0	10,0	14,0	14,0
1252508	C12A26544-0406M	Slip on nut	4	6,0	1/4"	6	9/16-18	39,0	11,0	14,0	19,0
1253029	C12A26544-0606M	Slip on nut	6	10,0	3/8"	6	9/16-18	46,0	11,0	17,0	19,0
1253030	C12A26544-0608M	Slip on nut	6	10,0	3/8"	8	3/4-16	47,0	15,0	17,0	22,0
1253031	C12A26544-0808M	Slip on nut	8	13,0	1/2"	8	3/4-16	52,0	15,0	19,0	22,0
1253032	C12A26544-0810M	Slip on nut	8	13,0	1/2"	10	7/8-14	51,0	16,0	19,0	27,0
1253033	C12A26544-1010M	Slip on nut	10	16,0	5/8"	10	7/8-14	65,0	16,0	24,0	27,0
1253034	C12A26544-1012M	Slip on nut	10	16,0	5/8"	12	1 1/16-12	69,0	21,0	24,0	32,0
1252209	C12A26544-1212M	Slip on nut	12	19,0	3/4"	12	1 1/16-12	67,0	21,0	27,0	32,0
1253035	C12A26544-1216M	Slip on nut	12	19,0	3/4"	16	1 5/16-12	71,0	24,0	27,0	41,0
1253036	C12A26544-1616M	Slip on nut	16	25,0	1"	16	1 5/16-12	80,0	24,0	32,0	41,0

// C12A22591-S
90° JIC Female 37° Seat
Short Drop
DKJ 90S
Solid one piece

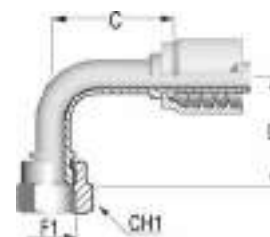

Item Code	Product Code	Nut Type	ID (Dash)	ID (mm)	ID (in)	F1 Dash	F1	C (mm)	D Drop (mm)	CH1 (mm)
1232883	C12A22591-0404S	Crimped	4	6,0	1/4"	4	7/16-20	27,0	21,0	16,0
1232885	C12A22591-0405S	Crimped	4	6,0	1/4"	5	1/2-20	26,5	23,5	17,0
1232887	C12A22591-0406S	Crimped	4	6,0	1/4"	6	9/16-18	31,0	23,0	19,0
1232895	C12A22591-0608S	Crimped	6	10,0	3/8"	8	3/4-16	48,8	29,0	25,0
1232898	C12A22591-0808S	Crimped	8	13,0	1/2"	8	3/4-16	46,4	29,0	25,0
1232901	C12A22591-0810S	Crimped	8	13,0	1/2"	10	7/8-14	45,8	32,0	27,0
1232903	C12A22591-0812S	Crimped	8	13,0	1/2"	12	1 1/16-12	37,3	46,0	32,0
1232907	C12A22591-1012S	Crimped	10	16,0	5/8"	12	1 1/16-12	47,9	48,0	32,0
1232910	C12A22591-1212S	Crimped	12	19,0	3/4"	12	1 1/16-12	58,2	46,0	32,0
1232912	C12A22591-1216S	Crimped	12	19,0	3/4"	16	1 5/16-12	53,6	53,0	38,0
1232915	C12A22591-1616S	Crimped	16	25,0	1"	16	1 5/16-12	74,0	56,0	38,0

// C12A26594-S NEW
90° JIC Female 37° Seat
Short Drop
Solid Nut and double Hexagon crimped

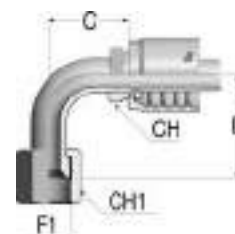

Item Code	Product Code	Nut Type	ID (Dash)	ID (mm)	ID (in)	F1 Dash	F1	C (mm)	D Drop (mm)	CH (mm)	CH1 (mm)
1253039	C12A26594-0404S	Slip on nut	4	6,0	1/4"	4	7/16-20	27,0	21,0	14,0	14,0
1253042	C12A26594-0405S	Slip on nut	4	6,0	1/4"	5	1/2-20	26,5	21,0	14,0	17,0
1253044	C12A26594-0406S	Slip on nut	4	6,0	1/4"	6	9/16-18	31,0	23,0	14,0	19,0
1253052	C12A26594-0506S	Slip on nut	5	8,0	5/16"	6	9/16-18	41,0	23,0	14,0	19,0
1253055	C12A26594-0606S	Slip on nut	6	10,0	3/8"	6	9/16-18	40,0	24,5	17,0	19,0
1253057	C12A26594-0608S	Slip on nut	6	10,0	3/8"	8	3/4-16	49,0	29,0	17,0	22,0
1252206	C12A26594-0808S	Slip on nut	8	13,0	1/2"	8	3/4-16	48,0	29,0		22,0
1253061	C12A26594-0810S	Slip on nut	8	13,0	1/2"	10	7/8-14	46,0	32,0	19,0	27,0
1253064	C12A26594-1012S	Slip on nut	10	16,0	5/8"	12	1 1/16-12	42,5	37,0	24,0	32,0
1252213	C12A26594-1212S	Slip on nut	12	19,0	3/4"	12	1 1/16-12	58,2	46,0		32,0
1253068	C12A26594-1616S	Slip on nut	16	25,0	1"	16	1 5/16-12	74,0	56,0	32,0	41,0

Product Codes roots ending with 3: insert with turned ring (ex. C12A22593).

Design and dimensions shown may be changed without prior notice

// C12A22591-M

90° JIC Female 37° Seat

Medium Drop

DKJ 90M

Solid one piece

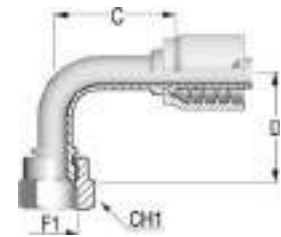

Item Code	Product Code	Nut Type	ID (Dash)	ID (mm)	ID (in)	F1 Dash	F1	C (mm)	D Drop (mm)	CH1 (mm)
1232882	C12A22591-0404M	Crimped	4	6,0	1/4"	4	7/16-20	34,2	32,0	16,0
1232884	C12A22591-0405M	Crimped	4	6,0	1/4"	5	1/2-20	25,7	30,0	17,0
1232886	C12A22591-0406M	Crimped	4	6,0	1/4"	6	9/16-18	28,5	38,0	19,0
1232888	C12A22591-0505M	Crimped	5	8,0	5/16"	5	1/2-20	34,2	32,0	17,0
1232889	C12A22591-0506M	Crimped	5	8,0	5/16"	6	9/16-18	33,2	35,0	19,0
1232891	C12A22591-0606M	Crimped	6	10,0	3/8"	6	9/16-18	31,3	35,0	19,0
1232894	C12A22591-0608M	Crimped	6	10,0	3/8"	8	3/4-16	39,5	41,0	25,0
1232897	C12A22591-0808M	Crimped	8	13,0	1/2"	8	3/4-16	37,2	40,0	25,0
1232902	C12A22591-0812M	Crimped	8	13,0	1/2"	12	1 1/16-12	42,8	58,0	32,0
1232905	C12A22591-1010M	Crimped	10	16,0	5/8"	10	7/8-14	49,4	48,0	27,0
1232906	C12A22591-1012M	Crimped	10	16,0	5/8"	12	1 1/16-12	47,9	58,0	32,0
1232909	C12A22591-1212M	Crimped	12	19,0	3/4"	12	1 1/16-12	52,4	54,0	32,0
1232911	C12A22591-1216M	Crimped	12	19,0	3/4"	16	1 5/16-12	52,6	72,0	38,0
1232914	C12A22591-1616M	Crimped	16	25,0	1"	16	1 5/16-12	72,6	71,5	38,0
1232916	C12A22592-1620M	Thrust wire nut	16	25,0	1"	20	1 5/8-12	72,6	78,0	50,0

Image: insert with Crimped Nut.

// C12A26594-M **NEW**

90° JIC Female 37° Seat

Medium Drop

Solid Nut and double Hexagon crimped

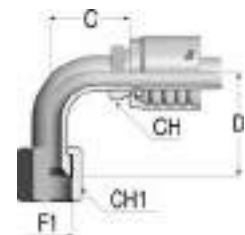

Item Code	Product Code	Nut Type	ID (Dash)	ID (mm)	ID (in)	F1 Dash	F1	C (mm)	D Drop (mm)	CH (mm)	CH1 (mm)
1253038	C12A26594-0404M	Slip on nut	4	6,0	1/4"	4	7/16-20	34,0	32,0	14,0	14,0
1253041	C12A26594-0405M	Slip on nut	4	6,0	1/4"	5	1/2-20	26,0	32,0	14,0	17,0
1253043	C12A22593-0406M	Slip on nut	4	6,0	1/4"	6	9/16-18	31,0	38,0		19,0
1253050	C12A26594-0505M	Slip on nut	5	8,0	5/16"	5	1/2-20	34,0	32,0	14,0	17,0
1253051	C12A26594-0506M	Slip on nut	5	8,0	5/16"	6	9/16-18	38,0	35,0	14,0	19,0
1253054	C12A26594-0606M	Slip on nut	6	10,0	3/8"	6	9/16-18	31,5	38,0	17,0	19,0
1253056	C12A22593-0608M	Slip on nut	6	10,0	3/8"	8	3/4-16	41,0	39,5		22,0
1252208	C12A26594-0808M	Slip on nut	8	13,0	1/2"	8	3/4-16	37,2	41,0		22,0
1253060	C12A26594-0810M	Slip on nut	8	13,0	1/2"	10	7/8-14	43,5	47,0	19,0	27,0
1253063	C12A26594-1010M	Slip on nut	10	16,0	5/8"	10	7/8-14	49,5	47,0	24,0	27,0
1253009	C12A26594-1012M	Slip on nut	10	16,0	5/8"	12	1 1/16-12	48,0	58,0	24,0	32,0
1252211	C12A26594-1212M	Slip on nut	12	19,0	3/4"	12	1 1/16-12	52,4	54,0		32,0
1253101	C12A22593-1216M	Slip on nut	12	19,0	3/4"	16	1 5/16-12	52,5	71,0		41,0
1253067	C12A26594-1616M	Slip on nut	16	25,0	1"	16	1 5/16-12	73,0	71,0	32,0	41,0

Product Codes roots ending with 3: insert with turned ring (ex. C12A22593).

// C12A22591-L

90° JIC Female 37° Seat

Long Drop

DKJ 90L

Solid one piece

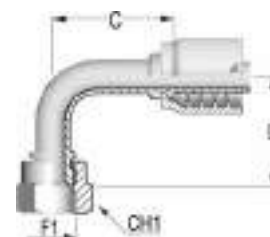

Item Code	Product Code	Nut Type	ID (Dash)	ID (mm)	ID (in)	F1 Dash	F1	C (mm)	D Drop (mm)	CH1 (mm)
1232890	C12A22591-0606L	Crimped	6	10,0	3/8"	6	9/16-18	43,3	54,0	19,0
1232893	C12A22591-0608L	Crimped	6	10,0	3/8"	8	3/4-16	46,8	64,0	25,0
1232899	C12A22591-0810L	Crimped	8	13,0	1/2"	10	7/8-14	37,3	65,0	27,0
1232904	C12A22591-1010L	Crimped	10	16,0	5/8"	10	7/8-14	49,9	65,0	27,0
1232908	C12A22591-1212L	Crimped	12	19,0	3/4"	12	1 1/16-12	54,1	95,0	32,0

// C12A26594-L NEW

90° JIC Female 37° Seat

Long Drop

Solid Nut and double Hexagon crimped

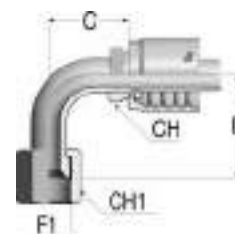

Item Code	Product Code	Nut Type	ID (Dash)	ID (mm)	ID (in)	F1 Dash	F1	C (mm)	D Drop (mm)	CH (mm)	CH1 (mm)
1253037	C12A26594-0404L	Slip on nut	4	6,0	1/4"	4	7/16-20	31,0	46,0	14,0	14,0
1253040	C12A26594-0405L	Slip on nut	4	6,0	1/4"	5	1/2-20	31,0	46,0	14,0	17,0
1253053	C12A26594-0606L	Slip on nut	6	10,0	3/8"	6	9/16-18	43,5	54,0	17,0	19,0
1253058	C12A26594-0808L	Slip on nut	8	13,0	1/2"	8	3/4-16	50,0	64,0	19,0	22,0
1253059	C12A26594-0810L	Slip on nut	8	13,0	1/2"	10	7/8-14	37,0	65,0	19,0	27,0
1253062	C12A26594-1010L	Slip on nut	10	16,0	5/8"	10	7/8-14	50,0	70,0	24,0	27,0
1253065	C12A26594-1212L	Slip on nut	12	19,0	3/4"	12	1 1/16-12	54,0	96,0	27,0	32,0
1253066	C12A26594-1616L	Slip on nut	16	25,0	1"	16	1 5/16-12	79,0	114,0	32,0	41,0

Product Codes roots ending with 3: insert with turned ring (ex. C12A22593).

Design and dimensions shown may be changed without prior notice

// NPTF INSERTS

// C12A12810

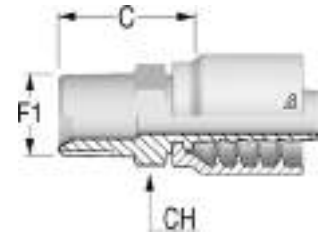
NPTF Male 60° Seat
AGN

Item Code	Product Code	ID (Dash)	ID (mm)	ID (in)	F1 Dash	F1	C (mm)	CH (mm)
1232624	C12A12810-04020	4	6,0	1/4"	2	1/8-27	21,3	14,0
1232650	C12A1281P-04040	4	6,0	1/4"	4	1/4-18	26,8	14,3
1232625	C12A12810-04060	4	6,0	1/4"	6	3/8-18	27,8	17,0
1232626	C12A12810-04080	4	6,0	1/4"	8	1/2-14	31,3	22,0
1232627	C12A12810-05040	5	8,0	5/16"	4	1/4-18	26,8	19,0
1232628	C12A12810-05060	5	8,0	5/16"	6	3/8-18	27,8	22,0
1232629	C12A12810-06040	6	10,0	3/8"	4	1/4-18	26,8	17,0
1232630	C12A12810-06060	6	10,0	3/8"	6	3/8-18	27,8	19,0
1232631	C12A12810-06080	6	10,0	3/8"	8	1/2-14	31,3	22,0
1232632	C12A12810-08060	8	13,0	1/2"	6	3/8-18	28,6	17,0
1232633	C12A12810-08080	8	13,0	1/2"	8	1/2-14	32,1	19,0
1232634	C12A12810-08120	8	13,0	1/2"	12	3/4-14	34,1	22,0
1232635	C12A12810-10080	10	16,0	5/8"	8	1/2-14	33,1	22,0
1232636	C12A12810-10120	10	16,0	5/8"	12	3/4-14	34,1	25,0
1232637	C12A12810-12080	12	19,0	3/4"	8	1/2-14	33,6	19,0
1232638	C12A12810-12120	12	19,0	3/4"	12	3/4-14	34,6	22,0
1232639	C12A12810-12160	12	19,0	3/4"	16	1-11 1/2	43,6	22,0
1232640	C12A12810-16160	16	25,0	1"	16	1-11 1/2	44,4	25,0
1232641	C12A12810-16200	16	25,0	1"	20	1 1/4-11 1/2	47,4	27,0

// C12A22810

NPTF Female Solid

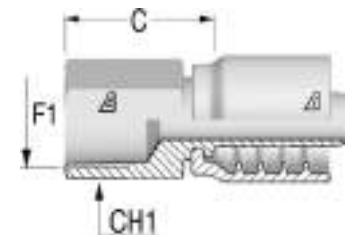

Item Code	Product Code	ID (Dash)	ID (mm)	ID (in)	F1 Dash	F1	C (mm)	CH (mm)
1232917	C12A22810-04040	4	6,0	1/4"	4	1/4-18	27,8	19,0
1232918	C12A22810-06060	6	10,0	3/8"	6	3/8-18	28,8	22,0
1232919	C12A22810-08080	8	13,0	1/2"	8	1/2-14	35,6	25,0
1232920	C12A22810-12120	12	19,0	3/4"	12	3/4-14	38,1	32,0
1232921	C12A22810-16160	16	25,0	1"	16	1-11 1/2	44,9	38,0

// C12A12811
NPTF Male Swivel 60° Seat

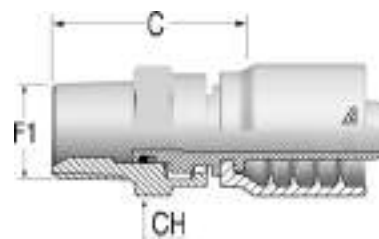

Item Code	Product Code	Nut Type	ID (Dash)	ID (mm)	ID (in)	F1 Dash	F1	C (mm)	CH (mm)
1232642	C12A12811-04040	Crimped	4	6,0	1/4"	4	1/4-18	37,6	24,0
1232643	C12A12811-06040	Crimped	6	10,0	3/8"	4	1/4-18	39,6	27,0
1232644	C12A12811-06060	Crimped	6	10,0	3/8"	6	3/8-18	37,5	27,0
1232645	C12A12811-06080	Crimped	6	10,0	3/8"	8	1/2-14	43,5	32,0
1232646	C12A12811-08060	Crimped	8	13,0	1/2"	6	3/8-18	38,3	36,0
1232647	C12A12811-08080	Crimped	8	13,0	1/2"	8	1/2-14	42,3	36,0
1232648	C12A12811-12120	Crimped	12	19,0	3/4"	12	3/4-14	50,1	41,0
1232649	C12A12811-16160	Crimped	16	25,0	1"	16	1-11 1/2	57,9	41,0

// C12A12881
90° Compact NPTF Male Swivel 60° Seat

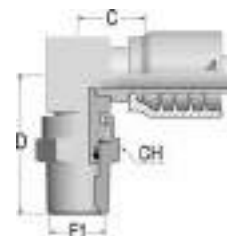

Item Code	Product Code	Nut Type	ID (Dash)	ID (mm)	ID (in)	F1 Dash	F1	C (mm)	D Drop (mm)	CH (mm)
1232651	C12A12881-04040	Crimped	4	6,0	1/4"	4	1/4-18	17,0	39,0	17,0
1232652	C12A12881-06060	Crimped	6	10,0	3/8"	6	3/8-18	20,0	41,0	22,0
1232653	C12A12881-08080	Crimped	8	13,0	1/2"	8	1/2-14	23,0	48,0	22,0

Design and dimensions shown may be changed without prior notice

// NPSM INSERTS

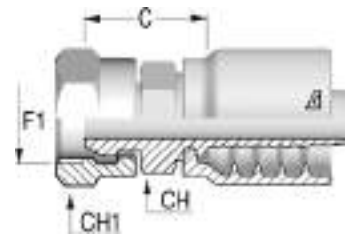
// C12A27311
NPSM Female

Item Code	Product Code	Nut Type	ID (Dash)	ID (mm)	ID (in)	F1 Dash	F1	C (mm)	CH (mm)	CH1 (mm)
1232957	C12A27311-04040	Crimped	4	6,0	1/4"	4	1/4-18	24,3	19,0	19,0
1232958	C12A27311-06060	Crimped	6	10,0	3/8"	6	3/8-18	24,8	22,0	22,0
1232959	C12A27311-08080	Crimped	8	13,0	1/2"	8	1/2-14	26,6	22,0	27,0
1232960	C12A27311-12120	Crimped	12	19,0	3/4"	12	3/4-14	28,6	32,0	32,0
1232961	C12A27311-16160	Crimped	16	25,0	1"	16	1-11 1/2	35,4	36,0	38,0

// ORFS INSERTS

// C12A12410 ORFS Male

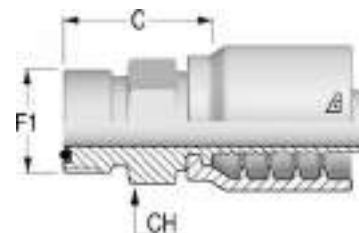

Item Code	Product Code	ID (Dash)	ID (mm)	ID (in)	F1 Dash	F1	C (mm)	CH (mm)
1232593	C12A12410-04040	4	6,0	1/4"	4	9/16-18	22,3	17,0
1232594	C12A12410-04060	4	6,0	1/4"	6	11/16-16	24,3	19,0
1232595	C12A12410-06060	6	10,0	3/8"	6	11/16-16	24,3	19,0
1232596	C12A12410-06080	6	10,0	3/8"	8	13/16-16	26,3	22,0
1232597	C12A12410-06100	6	10,0	3/8"	10	1-14	29,8	27,0
1232598	C12A12410-08080	8	13,0	1/2"	8	13/16-16	27,1	22,0
1232599	C12A12410-08100	8	13,0	1/2"	10	1-14	30,6	27,0
1232600	C12A12410-08120	8	13,0	1/2"	12	1 3/16-12	34,1	32,0
1232601	C12A12410-10100	10	16,0	5/8"	10	1-14	30,6	27,0
1232602	C12A12410-10120	10	16,0	5/8"	12	1 3/16-12	34,1	32,0
1232603	C12A12410-12120	12	19,0	3/4"	12	1 3/16-12	34,6	32,0
1232604	C12A12410-12160	12	19,0	3/4"	16	1 7/16-12	38,1	41,0
1232605	C12A12410-16160	16	25,0	1"	16	1 7/16-12	37,9	38,0

// C12A22414 **NEW** ORFS Female with support Hexagon knurled

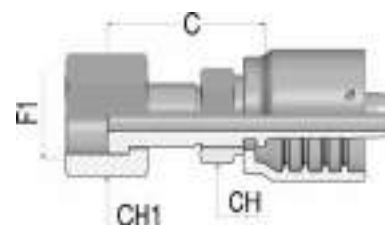

Item Code	Product Code	Nut Type	ID (Dash)	ID (mm)	ID (in)	F1 Dash	F1	C (mm)	CH (mm)	CH1 (mm)
1249411	C12A22414-04040	Slip on nut	4	6,0	1/4"	4	9/16-18	29,5	14,0	17,0
1249412	C12A22414-04060	Slip on nut	4	6,0	1/4"	6	11/16-16	31,8	17,0	22,0
1249413	C12A22414-04080	Slip on nut	4	6,0	1/4"	8	13/16-16	35,8	22,0	24,0
1249414	C12A22414-05060	Slip on nut	5	8,0	5/16"	6	11/16-16	30,8	17,0	22,0
1249415	C12A22414-06060	Slip on nut	6	10,0	3/8"	6	11/16-16	30,8	17,0	22,0
1249416	C12A22414-06080	Slip on nut	6	10,0	3/8"	8	13/16-16	39,3	22,0	24,0
1249418	C12A22414-08080	Slip on nut	8	13,0	1/2"	8	13/16-16	40,5	22,0	24,0
1249419	C12A22414-08100	Slip on nut	8	13,0	1/2"	10	1-14	43,0	24,0	30,0
1249420	C12A22414-08120	Slip on nut	8	13,0	1/2"	12	1 3/16-12	42,1	30,0	36,0
1249421	C12A22414-10100	Slip on nut	10	16,0	5/8"	10	1-14	45,0	24,0	30,0
1249422	C12A22414-10120	Slip on nut	10	16,0	5/8"	12	1 3/16-12	42,1	30,0	36,0
1249423	C12A22414-12120	Slip on nut	12	19,0	3/4"	12	1 3/16-12	42,6	30,0	36,0
1249424	C12A22414-12160	Slip on nut	12	19,0	3/4"	16	1 7/16-12	42,6	36,0	41,0
1249425	C12A22414-16160	Slip on nut	16	25,0	1"	16	1 7/16-12	51,4	36,0	41,0

Design and dimensions shown may be changed without prior notice

// C12A22443-S
45° ORFS Female
Short Drop
DK ORFS 45M
Solid one piece

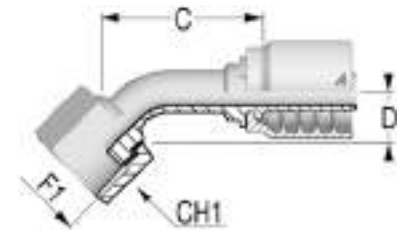

Item Code	Product Code	Nut Type	ID (Dash)	ID (mm)	ID (in)	F1 Dash	F1	C (mm)	D Drop (mm)	CH1 (mm)
1232802	C12A22443-0404S	Slip on nut	4	6,0	1/4"	4	9/16-18	41,1	11,0	17,0
1232803	C12A22443-0406S	Slip on nut	4	6,0	1/4"	6	11/16-16	46,1	11,0	22,0
1232804	C12A22443-0506S	Slip on nut	5	8,0	5/16"	6	11/16-16	46,3	12,0	22,0
1232805	C12A22443-0606S	Slip on nut	6	10,0	3/8"	6	11/16-16	47,4	12,0	22,0
1232806	C12A22443-0608S	Slip on nut	6	10,0	3/8"	8	13/16-16	51,2	15,0	24,0
1232801	C12A22441-0808S	Crimped	8	13,0	1/2"	8	13/16-16	47,1	16,0	24,0
1232807	C12A22443-0810S	Slip on nut	8	13,0	1/2"	10	1-14	50,4	16,5	30,0
1232808	C12A22443-1010S	Slip on nut	10	16,0	5/8"	10	1-14	57,7	17,0	30,0
1232809	C12A22443-1012S	Slip on nut	10	16,0	5/8"	12	1 3/16-12	63,1	21,0	36,0
1232810	C12A22443-1212S	Slip on nut	12	19,0	3/4"	12	1 3/16-12	63,5	21,0	36,0
1232811	C12A22443-1216S	Slip on nut	12	19,0	3/4"	16	1 7/16-12	70,7	24,0	41,0
1232812	C12A22443-1616S	Slip on nut	16	25,0	1"	16	1 7/16-12	82,4	26,0	41,0
1232813	C12A22443-1620S	Slip on nut	16	25,0	1"	20	1 11/16-12	85,4	26,0	50,0

Image: insert with Slip on Nut.

// C12A22493-S
90° ORFS Female
Short Drop
DK ORFS 90S
Solid one piece

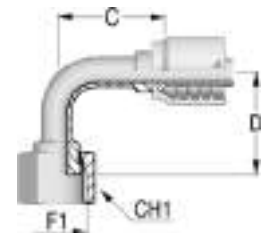

Item Code	Product Code	Nut Type	ID (Dash)	ID (mm)	ID (in)	F1 Dash	F1	C (mm)	D Drop (mm)	CH1 (mm)
1232819	C12A22493-0404S	Slip on nut	4	6,0	1/4"	4	9/16-18	28,5	21,0	17,0
1232822	C12A22493-0406S	Slip on nut	4	6,0	1/4"	6	11/16-16	32,0	23,0	22,0
1232826	C12A22493-0606S	Slip on nut	6	10,0	3/8"	6	11/16-16	41,8	25,0	22,0
1232829	C12A22493-0608S	Slip on nut	6	10,0	3/8"	8	13/16-16	41,8	29,0	24,0
1232816	C12A22491-0808S	Crimped	8	13,0	1/2"	8	13/16-16	39,8	29,0	24,0
1232832	C12A22493-0810S	Slip on nut	8	13,0	1/2"	10	1-14	46,3	32,5	30,0
1232835	C12A22493-1010S	Slip on nut	10	16,0	5/8"	10	1-14	52,3	32,5	30,0
1232837	C12A22493-1012S	Slip on nut	10	16,0	5/8"	12	1 3/16-12	55,4	49,0	36,0
1232840	C12A22493-1212S	Slip on nut	12	19,0	3/4"	12	1 3/16-12	60,6	51,0	36,0
1232842	C12A22493-1216S	Slip on nut	12	19,0	3/4"	16	1 7/16-12	61,6	56,0	41,0
1232845	C12A22493-1616S	Slip on nut	16	25,0	1"	16	1 7/16-12	80,0	58,0	41,0
1232847	C12A22493-1620S	Slip on nut	16	25,0	1"	20	1 11/16-12	82,6	64,0	50,0

Image: insert with Slip on Nut.

// C12A22493-M

90° ORFS Female
Medium Drop
DK ORFS 90M
Solid one piece

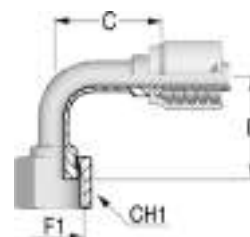

Item Code	Product Code	Nut Type	ID (Dash)	ID (mm)	ID (in)	F1 Dash	F1	C (mm)	D Drop (mm)	CH1 (mm)
1232818	C12A22493-0404M	Slip on nut	4	6,0	1/4"	4	9/16-18	29,8	32,0	17,0
1232821	C12A22493-0406M	Slip on nut	4	6,0	1/4"	6	11/16-16	37,3	38,0	22,0
1232823	C12A22493-0506M	Slip on nut	5	8,0	5/16"	6	11/16-16	40,7	34,0	22,0
1232825	C12A22493-0606M	Slip on nut	6	10,0	3/8"	6	11/16-16	41,8	38,0	22,0
1232828	C12A22493-0608M	Slip on nut	6	10,0	3/8"	8	13/16-16	43,8	41,0	24,0
1232815	C12A22491-0808M	Crimped	8	13,0	1/2"	8	13/16-16	34,8	42,0	24,0
1232831	C12A22493-0810M	Slip on nut	8	13,0	1/2"	10	1-14	48,3	47,0	30,0
1232834	C12A22493-1010M	Slip on nut	10	16,0	5/8"	10	1-14	55,4	44,0	30,0
1232836	C12A22493-1012M	Slip on nut	10	16,0	5/8"	12	1 3/16-12	55,4	58,0	36,0
1232839	C12A22493-1212M	Slip on nut	12	19,0	3/4"	12	1 3/16-12	61,6	58,0	36,0
1232841	C12A22493-1216M	Slip on nut	12	19,0	3/4"	16	1 7/16-12	65,6	71,0	41,0
1232844	C12A22493-1616M	Slip on nut	16	25,0	1"	16	1 7/16-12	82,6	66,0	41,0
1232846	C12A22493-1620M	Slip on nut	16	25,0	1"	20	1 11/16-12	82,6	78,0	50,0

Image: insert with Slip on Nut.

// C12A22493-L

90° ORFS Female
Long Drop
DK ORFS 90L
Solid one piece

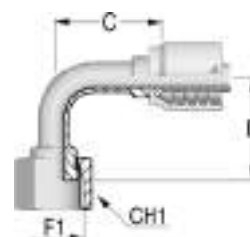

Item Code	Product Code	Nut Type	ID (Dash)	ID (mm)	ID (in)	F1 Dash	F1	C (mm)	D Drop (mm)	CH1 (mm)
1232817	C12A22493-0404L	Crimped	4	6,0	1/4"	4	9/16-18	32,8	46,0	24,0
1232820	C12A22493-0406L	Slip on nut	4	6,0	1/4"	6	11/16-16	34,8	54,0	30,0
1232824	C12A22493-0606L	Slip on nut	6	10,0	3/8"	6	11/16-16	41,8	54,0	30,0
1232827	C12A22493-0608L	Slip on nut	6	10,0	3/8"	8	13/16-16	46,8	64,0	30,0
1232814	C12A22491-0808L	Crimped	8	13,0	1/2"	8	13/16-16	38,3	64,0	30,0
1232830	C12A22493-0810L	Slip on nut	8	13,0	1/2"	10	1-14	46,3	70,0	36,0
1232833	C12A22493-1010L	Slip on nut	10	16,0	5/8"	10	1-14	55,4	70,0	36,0
1232838	C12A22493-1212L	Slip on nut	12	19,0	3/4"	12	1 3/16-12	61,6	96,0	41,0
1232843	C12A22493-1616L	Slip on nut	16	25,0	1"	16	1 7/16-12	82,6	114,0	41,0

Image: insert with Slip on Nut.

Design and dimensions shown may be changed without prior notice

// JIS INSERTS

// C12A2381Z

JIS Female 60° Seat Flare - B 8363 (type F)

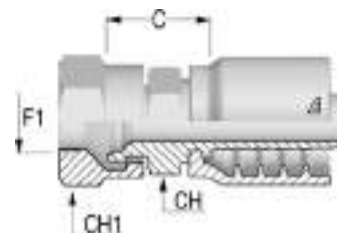

Item Code	Product Code	Nut Type	ID (Dash)	ID (mm)	ID (in)	F1 Dash	F1	C (mm)	CH (mm)	CH1 (mm)
1232922	C12A2381Z-04040	Crimped	4	6,0	1/4"	4	1/4-19	20,8	17,0	19,0
1232923	C12A2381Z-06060	Crimped	6	10,0	3/8"	6	3/8-19	21,8	19,0	22,0
1232924	C12A2381Z-08080	Crimped	8	13,0	1/2"	8	1/2-14	23,6	22,0	27,0
1232925	C12A2381Z-12120	Crimped	12	19,0	3/4"	12	3/4-14	27,1	30,0	36,0
1232926	C12A2381Z-16160	Crimped	16	25,0	1"	16	1-11	32,9	36,0	41,0

// KOMATSU INSERTS

// C12A24011

Komatsu Female

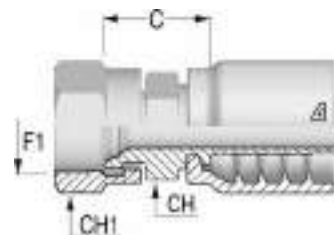

Item Code	Product Code	Nut Type	ID (Dash)	ID (mm)	ID (in)	F1 Dash	F1	C (mm)	CH (mm)	CH1 (mm)
1232927	C12A24011-04140	Crimped	4	6,0	1/4"	14	M14X1.5	20,8	17,0	19,0
1232928	C12A24011-06180	Crimped	6	10,0	3/8"	18	M18X1.5	21,8	19,0	22,0
1232929	C12A24011-08220	Crimped	8	13,0	1/2"	22	M22X1.5	23,6	22,0	27,0
1232930	C12A24011-10240	Crimped	10	16,0	5/8"	24	M24X1.5	27,1	32,0	32,0
1232931	C12A24011-12300	Crimped	12	19,0	3/4"	30	M30X1.5	27,6	30,0	36,0
1232932	C12A24011-16330	Crimped	16	25,0	1"	33	M33X1.5	35,7	41,0	41,0

Design and dimensions shown may be changed without prior notice

// SAE FLANGES

// C12A43310

Flange SAE 3000 psi J518 Code 61
SFL

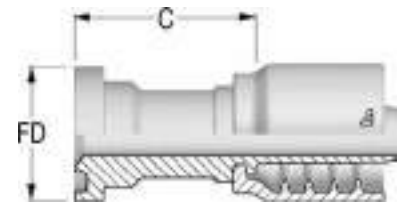

Item Code	Product Code	ID (Dash)	ID (mm)	ID (in)	F1 Dash	F1	FD (mm)	C (mm)	WP (psi)
1232962	C12A43310-08080	8	13,0	1/2"	8	1/2	30,2	41,0	5000
1232963	C12A43310-08120	8	13,0	1/2"	12	3/4	38,1	42,0	5000
1232964	C12A43310-12120	12	19,0	3/4"	12	3/4	38,1	42,5	5000
1232965	C12A43310-12160	12	19,0	3/4"	16	1	44,5	50,5	5000
1232966	C12A43310-16160	16	25,0	1"	16	1	44,5	51,4	5000
1232967	C12A43310-16200	16	25,0	1"	20	1 1/4	50,8	53,9	4000

Diametres from 1/2" include Whip Check Retention Nut.

// C12A43340

45° Flange SAE 3000 psi J518 Code 61
SFL 45
Solid one piece

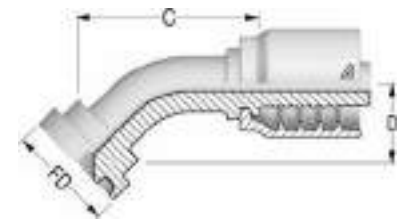

Item Code	Product Code	ID (Dash)	ID (mm)	ID (in)	F1 Dash	F1	FD (mm)	C (mm)	D Drop (mm)	WP (psi)
1232968	C12A43340-08080	8	13,0	1/2"	8	1/2	30,2	52,9	22,0	5000
1232969	C12A43340-08120	8	13,0	1/2"	12	3/4	38,1	60,3	26,0	5000
1232970	C12A43340-10120	10	16,0	5/8"	12	3/4	38,1	65,0	26,0	5000
1232971	C12A43340-12120	12	19,0	3/4"	12	3/4	38,1	73,7	32,0	5000
1232972	C12A43340-12160	12	19,0	3/4"	16	1	44,5	77,9	29,0	5000
1232973	C12A43340-16160	16	25,0	1"	16	1	44,5	82,7	33,5	5000
1232974	C12A43340-16200	16	25,0	1"	20	1 1/4	50,8	82,2	36,0	4000

// C12A43390

90° Flange SAE 3000 psi J518 Code 61

SFL 90

Solid one piece

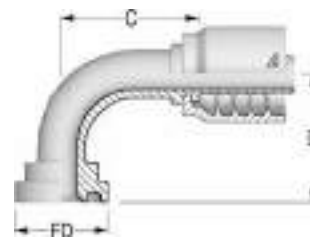

Item Code	Product Code	ID (Dash)	ID (mm)	ID (in)	F1 Dash	F1	FD (mm)	C (mm)	D Drop (mm)	WP (psi)
1232975	C12A43390-08080	8	13,0	1/2"	8	1/2	30,2	45,8	42,0	5000
1232976	C12A43390-08120	8	13,0	1/2"	12	3/4	38,1	45,3	51,0	5000
1232977	C12A43390-12120	12	19,0	3/4"	12	3/4	38,1	59,7	58,0	5000
1232978	C12A43390-12160	12	19,0	3/4"	16	1	44,5	66,2	64,5	5000
1232979	C12A43390-16160	16	25,0	1"	16	1	44,5	70,6	67,0	5000
1232980	C12A43390-16200	16	25,0	1"	20	1 1/4	50,8	73,6	71,0	4000
1232981	C12A43390-16240	16	25,0	1"	24	1 1/2	60,3	93,1	75,0	3000

// C12A43610

Flange SAE 6000 psi J518 Code 62

SFS

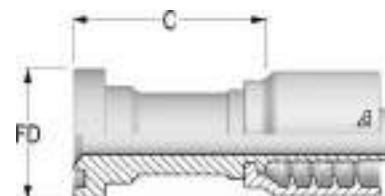

Item Code	Product Code	ID (Dash)	ID (mm)	ID (in)	F1 Dash	F1	FD (mm)	C (mm)	WP (psi)
1232982	C12A43610-08080	8	13,0	1/2"	8	1/2	31,8	47,0	6000
1232983	C12A43610-08120	8	13,0	1/2"	12	3/4	41,3	52,0	6000
1232984	C12A43610-12120	12	19,0	3/4"	12	3/4	41,3	52,5	6000
1232985	C12A43610-12160	12	19,0	3/4"	16	1	47,6	55,5	6000
1232986	C12A43610-16120	16	25,0	1"	12	3/4	41,3	56,4	6000
1232987	C12A43610-16160	16	25,0	1"	16	1	47,6	56,4	6000
1232988	C12A43610-16200	16	25,0	1"	20	1 1/4	54,0	63,4	6000

Diameters from 1/2" include Whip Check Retention Nut.

// C12A43640

45° Flange SAE 6000 psi J518 Code 62

SFS 45

Solid one piece

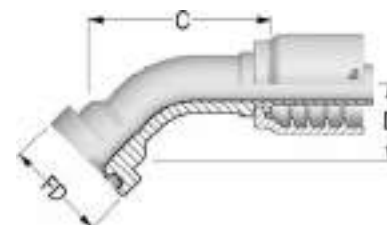

Item Code	Product Code	ID (Dash)	ID (mm)	ID (in)	F1 Dash	F1	FD (mm)	C (mm)	D Drop (mm)	WP (psi)
1232989	C12A43640-08080	8	13,0	1/2"	8	1/2	31,8	56,5	23,0	6000
1232990	C12A43640-08120	8	13,0	1/2"	12	3/4	41,3	79,9	30,5	6000
1232991	C12A43640-12120	12	19,0	3/4"	12	3/4	41,3	84,1	31,0	6000
1232992	C12A43640-12160	12	19,0	3/4"	16	1	47,6	80,0	33,5	6000
1232993	C12A43640-16160	16	25,0	1"	16	1	47,6	96,7	36,0	6000
1232994	C12A43640-16200	16	25,0	1"	20	1 1/4	54,0	96,1	39,0	6000

Design and dimensions shown may be changed without prior notice

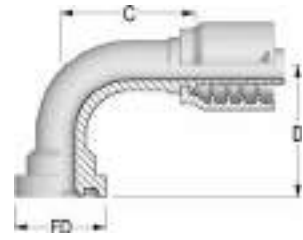
// C12A43690**90° Flange SAE 6000 psi J518 Code 62****SFS 90****Solid one piece**

Item Code	Product Code	ID (Dash)	ID (mm)	ID (in)	F1 Dash	F1	FD (mm)	C (mm)	D Drop (mm)	WP (psi)
1232995	C12A43690-08080	8	13,0	1/2"	8	1/2	31,8	47,8	46,0	6000
1232996	C12A43690-08120	8	13,0	1/2"	12	3/4	41,3	47,8	54,0	6000
1232997	C12A43690-10120	10	16,0	5/8"	12	3/4	41,3	49,9	55,0	6000
1232998	C12A43690-12120	12	19,0	3/4"	12	3/4	41,3	63,2	61,0	6000
1232999	C12A43690-12160	12	19,0	3/4"	16	1	47,6	63,2	66,0	6000
1233000	C12A43690-16160	16	25,0	1"	16	1	47,6	73,6	75,0	6000
1233001	C12A43690-16200	16	25,0	1"	20	1 1/4	54,0	77,6	78,0	6000



// ALFACRIMP C124 - ONE PIECE - FITTINGS

// BSP INSERTS.....	183	// NPTF INSERTS.....	197
// DIN METRIC INSERTS.....	186	// ORFS INSERTS.....	199
// SAE INSERTS.....	190	// SAE FLANGES.....	202
// JIC 37° INSERTS.....	191	// C122 SAE FLANGES.....	205

Design and dimensions shown may be changed without prior notice

// BSP INSERTS

// C12410510

BSPP Male 60° Flare
AGR

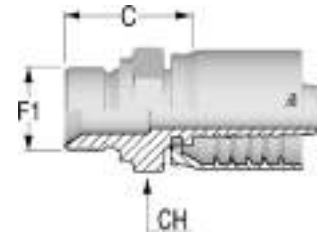

Item Code	Product Code	ID (Dash)	ID (mm)	ID (in)	F1 Dash	F1	C (mm)	CH (mm)
1215573	C12410510-06060	6	10,0	3/8"	6	3/8-19	27,8	22,0
1233019	C12410510-06080	6	10,0	3/8"	8	1/2-14	31,3	27,0
1233020	C12410510-08060	8	13,0	1/2"	6	3/8-19	28,6	22,0
1233021	C12410510-08080	8	13,0	1/2"	8	1/2-14	32,1	27,0
1233022	C12410510-08100	8	13,0	1/2"	10	5/8-14	34,1	30,0
1215574	C12410510-08120	8	13,0	1/2"	12	3/4-14	36,1	32,0
1233023	C12410510-10100	10	16,0	5/8"	10	5/8-14	34,1	30,0
1233024	C12410510-10120	10	16,0	5/8"	12	3/4-14	36,1	32,0
1215575	C12410510-12120	12	19,0	3/4"	12	3/4-14	36,6	32,0
1233025	C12410510-12160	12	19,0	3/4"	16	1-11	41,6	41,0
1215576	C12410510-16160	16	25,0	1"	16	1-11	42,4	41,0
1233026	C12410510-16200	16	25,0	1"	20	1 1/4-11	46,4	50,0
1215577	C12410510-20200	20	32,0	1 1/4"	20	1 1/4-11	48,0	50,0
1215578	C12410510-24240	24	38,0	1 1/2"	24	1 1/2-11	51,0	55,0
1215579	C12410510-32320	32	51,0	2"	32	2-11	53,5	70,0

// C12410710

BSPT Male
AGR K

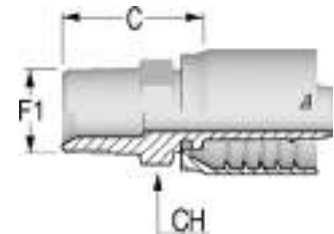

Item Code	Product Code	ID (Dash)	ID (mm)	ID (in)	F1 Dash	F1	C (mm)	CH (mm)
1215580	C12410710-06060	6	10,0	3/8"	6	3/8-19	27,8	19,0
1215581	C12410710-06080	6	10,0	3/8"	8	1/2-14	32,3	22,0
1215582	C12410710-08080	8	13,0	1/2"	8	1/2-14	33,1	22,0
1215583	C12410710-10120	10	16,0	5/8"	12	3/4-14	34,1	27,0
1215584	C12410710-12120	12	19,0	3/4"	12	3/4-14	34,6	27,0
1215585	C12410710-12160	12	19,0	3/4"	16	1-11	43,6	36,0
1215586	C12410710-16160	16	25,0	1"	16	1-11	44,4	36,0
1215587	C12410710-20200	20	32,0	1 1/4"	20	1 1/4-11	49,0	46,0
1215588	C12410710-24240	24	38,0	1 1/2"	24	1 1/2-11	50,5	50,0
1215589	C12410710-32320	32	51,0	2"	32	2-11	54,2	65,0

// C12420813

**BSPF Female 60° Cone with O-Ring
DKOR**

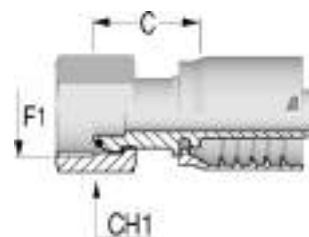

Item Code	Product Code	Nut Type	ID (Dash)	ID (mm)	ID (in)	F1 Dash	F1	C (mm)	CH1 (mm)
1215665	C12420813-06060	Slip on nut	6	10,0	3/8"	6	3/8-19	23,3	22,0
1215666	C12420813-06080	Slip on nut	6	10,0	3/8"	8	1/2-14	24,3	27,0
1215667	C12420813-08080	Slip on nut	8	13,0	1/2"	8	1/2-14	25,1	27,0
1215668	C12420813-08100	Slip on nut	8	13,0	1/2"	10	5/8-14	28,4	27,0
1215669	C12420813-08120	Slip on nut	8	13,0	1/2"	12	3/4-14	29,0	32,0
1215659	C12420811-10100	Crimped	10	16,0	5/8"	10	5/8-14	17,1	27,0
1215670	C12420813-10120	Slip on nut	10	16,0	5/8"	12	3/4-14	29,0	32,0
1215660	C12420811-12120	Crimped	12	19,0	3/4"	12	3/4-14	20,6	32,0
1215671	C12420813-12160	Slip on nut	12	19,0	3/4"	16	1-11	34,0	38,0
1215661	C12420811-16160	Crimped	16	25,0	1"	16	1-11	23,9	38,0
1215672	C12420813-16200	Slip on nut	16	25,0	1"	20	1 1/4-11	39,4	50,0
1215662	C12420812-20200	Thrust wire nut	20	32,0	1 1/4"	20	1 1/4-11	32,0	50,0
1215673	C12420813-20240	Slip on nut	20	32,0	1 1/4"	24	1 1/2-11	41,9	55,0
1215663	C12420812-24240	Thrust wire nut	24	38,0	1 1/2"	24	1 1/2-11	33,8	55,0
1215664	C12420812-32320	Thrust wire nut	32	51,0	2"	32	2-11	34,0	70,0

Image: insert with Slip on Nut.

// C12420843

**45° BSPF Female 60° Cone with O-Ring
DKOR 45
Solid one piece**

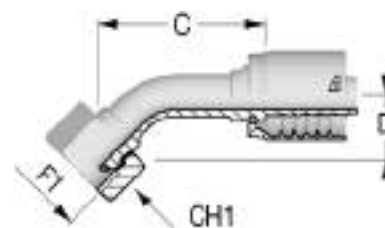

Item Code	Product Code	Nut Type	ID (Dash)	ID (mm)	ID (in)	F1 Dash	F1	C (mm)	D Drop (mm)	CH1 (mm)
1215681	C12420843-06060	Slip on nut	6	10,0	3/8"	6	3/8-19	49,9	20,5	22,0
1215682	C12420843-06080	Slip on nut	6	10,0	3/8"	8	1/2-14	45,7	21,0	27,0
1215683	C12420843-08080	Slip on nut	8	13,0	1/2"	8	1/2-14	55,0	21,0	27,0
1215684	C12420843-08100	Slip on nut	8	13,0	1/2"	10	5/8-14	57,2	23,0	27,0
1215685	C12420843-08120	Slip on nut	8	13,0	1/2"	12	3/4-14	56,7	23,0	32,0
1215674	C12420841-10100	Crimped	10	16,0	5/8"	10	5/8-14	64,0	21,5	27,0
1215686	C12420843-10120	Slip on nut	10	16,0	5/8"	12	3/4-14	66,5	22,5	32,0
1215675	C12420841-12120	Crimped	12	19,0	3/4"	12	3/4-14	70,0	28,0	32,0
1215687	C12420843-12160	Slip on nut	12	19,0	3/4"	16	1-11	74,6	31,5	38,0
1215677	C12420841-16160	Crimped	16	25,0	1"	16	1-11	84,0	34,0	38,0
1215678	C12420842-20200	Thrust wire nut	20	32,0	1 1/4"	20	1 1/4-11	100,8	40,0	50,0
1215679	C12420842-24240	Thrust wire nut	24	38,0	1 1/2"	24	1 1/2-11	115,7	46,0	55,0
1215680	C12420842-32320	Thrust wire nut	32	51,0	2"	32	2-11	151,5	60,0	70,0

Image: insert with Slip on Nut.

Design and dimensions shown may be changed without prior notice

// C12420893

90° BSPF Female 60° Cone with O-Ring

DKOR 90

Solid one piece

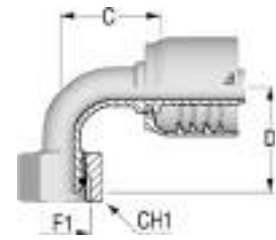

Item Code	Product Code	Nut Type	ID (Dash)	ID (mm)	ID (in)	F1 Dash	F1	C (mm)	D Drop (mm)	CH1 (mm)
1215696	C12420893-06060	Slip on nut	6	10,0	3/8"	6	3/8-19	34,8	42,0	22,0
1215697	C12420893-06080	Slip on nut	6	10,0	3/8"	8	1/2-14	34,3	35,5	27,0
1215698	C12420893-08080	Slip on nut	8	13,0	1/2"	8	1/2-14	35,8	41,0	27,0
1215699	C12420893-08100	Slip on nut	8	13,0	1/2"	10	5/8-14	41,6	43,5	27,0
1233027	C12420893-08120	Slip on nut	8	13,0	1/2"	12	3/4-14	41,8	43,0	32,0
1215690	C12420891-10100	Crimped	10	16,0	5/8"	10	5/8-14	47,9	47,0	27,0
1233028	C12420893-10120	Slip on nut	10	16,0	5/8"	12	3/4-14	51,9	49,0	32,0
1215691	C12420891-12120	Crimped	12	19,0	3/4"	12	3/4-14	49,1	53,0	32,0
1215700	C12420893-12160	Slip on nut	12	19,0	3/4"	16	1-11	54,1	60,5	38,0
1215692	C12420891-16160	Crimped	16	25,0	1"	16	1-11	75,1	69,0	38,0
1233029	C12420893-16200	Slip on nut	16	25,0	1"	20	1 1/4-11	75,1	88,5	50,0
1215693	C12420892-20200	Thrust wire nut	20	32,0	1 1/4"	20	1 1/4-11	82,3	83,0	50,0
1215694	C12420892-24240	Thrust wire nut	24	38,0	1 1/2"	24	1 1/2-11	95,7	96,0	55,0
1215695	C12420892-32320	Thrust wire nut	32	51,0	2"	32	2-11	128,5	136,0	70,0

Image: insert with Slip on Nut.

// DIN METRIC INSERTS

// C12411110

Metric Male 24° Seat
DIN 3853 - Light Series
CEL

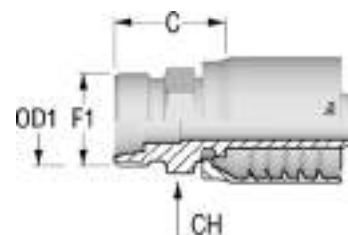

Item Code	Product Code	ID (Dash)	ID (mm)	ID (in)	F1	OD1	C (mm)	CH (mm)
1215591	C12411110-06180	6	10,0	3/8"	M18X1.5	12	24,3	19,0
1230378	C12411110-06220	6	10,0	3/8"	M22X1.5	15	25,3	22,0
1215590	C12411110-06160	6	10,0	3/8"	M16X1.5	10	23,3	17,0
1215592	C12411110-08220	8	13,0	1/2"	M22X1.5	15	26,1	22,0
1230379	C12411110-08260	8	13,0	1/2"	M26X1.5	18	27,1	27,0
1215593	C12411110-10260	10	16,0	5/8"	M26X1.5	18	27,1	27,0
1215594	C12411110-12300	12	19,0	3/4"	M30X2	22	31,6	32,0
1215595	C12411110-16360	16	25,0	1"	M36X2	28	34,4	36,0
1215596	C12411110-20450	20	32,0	1 1/4"	M45X2	35	40,0	46,0
1233030	C12411110-24520	24	38,0	1 1/2"	M52X2	42	42,0	55,0

// C12421513

Metric Female 24° Cone with O-Ring
ISO 8434-1 - Light Series
DKOL

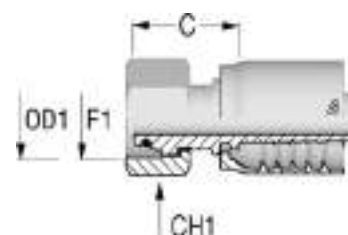

Item Code	Product Code	Nut Type	ID (Dash)	ID (mm)	ID (in)	F1	OD1	C (mm)	CH1 (mm)
1215702	C12421513-06180	Slip on nut	6	10,0	3/8"	M18X1.5	12	25,4	22,0
1215703	C12421513-08220	Slip on nut	8	13,0	1/2"	M22X1.5	15	28,2	27,0
1215704	C12421513-10260	Slip on nut	10	16,0	5/8"	M26X1.5	18	29,2	32,0
1215705	C12421513-12300	Slip on nut	12	19,0	3/4"	M30X2	22	31,7	36,0
1215706	C12421513-16360	Slip on nut	16	25,0	1"	M36X2	28	33,6	41,0
1215707	C12421513-20450	Slip on nut	20	32,0	1 1/4"	M45X2	35	40,1	50,0
1230386	C12421513-24520	Slip on nut	24	38,0	1 1/2"	M52X2	42	40,5	60,0

Design and dimensions shown may be changed without prior notice

// C12421543

45° Metric Female 24° Cone with O-Ring

ISO 8434-1 - Light Series

DKOL 45

Solid one piece

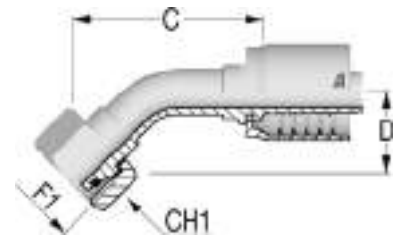

Item Code	Product Code	Nut Type	ID (Dash)	ID (mm)	ID (in)	F1	OD1	C (mm)	D Drop (mm)	CH1 (mm)
1215708	C12421543-06180	Slip on nut	6	10,0	3/8"	M18X1.5	12	46,8	19,5	22,0
1215709	C12421543-08220	Slip on nut	8	13,0	1/2"	M22X1.5	15	55,0	21,0	22,0
1215710	C12421543-10260	Slip on nut	10	16,0	5/8"	M26X1.5	18	65,3	24,0	32,0
1215711	C12421543-12300	Slip on nut	12	19,0	3/4"	M30X2	22	69,4	32,0	36,0
1215712	C12421543-16360	Slip on nut	16	25,0	1"	M36X2	28	91,4	32,0	41,0
1233031	C12421543-20450	Slip on nut	20	32,0	1 1/4"	M45X2	35	141,5	45,0	50,0

// C12421593

90° Metric Female 24° Cone with O-Ring

ISO 8434-1 - Light Series

DKOL 90

Solid one piece

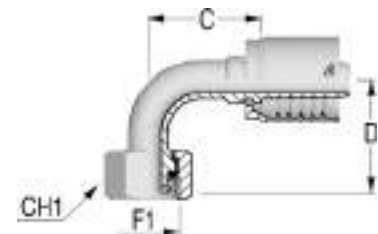

Item Code	Product Code	Nut Type	ID (Dash)	ID (mm)	ID (in)	F1	OD1	C (mm)	D Drop (mm)	CH1 (mm)
1215713	C12421593-06180	Slip on nut	6	10,0	3/8"	M18X1.5	12	32,8	39,0	22,0
1215714	C12421593-08220	Slip on nut	8	13,0	1/2"	M22X1.5	15	39,8	40,5	27,0
1215715	C12421593-10260	Slip on nut	10	16,0	5/8"	M26X1.5	18	51,4	48,0	32,0
1215716	C12421593-12300	Slip on nut	12	19,0	3/4"	M30X2	22	52,1	59,0	36,0
1215717	C12421593-16360	Slip on nut	16	25,0	1"	M36X2	28	77,6	68,0	41,0
1215718	C12421593-20450	Slip on nut	20	32,0	1 1/4"	M45X2	35	90,5	89,0	50,0
1230388	C12421593-24520	Slip on nut	24	38,0	1 1/2"	M52X2	42	106,5	100,0	60,0

// C12411210

Metric Male 24° Seat

DIN 3853 - Heavy Series

CES

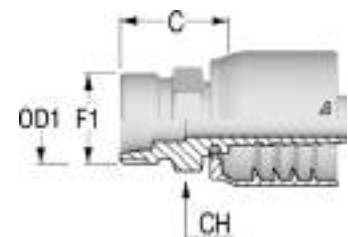

Item Code	Product Code	ID (Dash)	ID (mm)	ID (in)	F1	OD1	C (mm)	CH (mm)
1215597	C12411210-06200	6	10,0	3/8"	M20X1.5	12	25,3	22,0
1215598	C12411210-06220	6	10,0	3/8"	M22X1.5	14	27,3	22,0
1215599	C12411210-08240	8	13,0	1/2"	M24X1.5	16	29,1	24,0
1215600	C12411210-10300	10	16,0	5/8"	M30X2	20	33,1	32,0
1215601	C12411210-12300	12	19,0	3/4"	M30X2	20	33,6	32,0
1215602	C12411210-12360	12	19,0	3/4"	M36X2	25	37,6	36,0
1215603	C12411210-16420	16	25,0	1"	M42X2	30	42,4	46,0
1233032	C12411210-20520	20	32,0	1 1/4"	M52X2	38	48,0	55,0

// C12421613

Metric Female 24° Cone with O-Ring
ISO 8434-1 - Heavy Series
DKOS

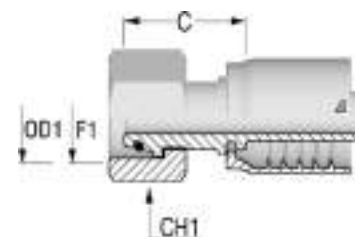

Item Code	Product Code	Nut Type	ID (Dash)	ID (mm)	ID (in)	F1	OD1	C (mm)	CH1 (mm)
1215720	C12421613-06200	Slip on nut	6	10,0	3/8"	M20X1.5	12	27,6	24,0
1215721	C12421613-06220	Slip on nut	6	10,0	3/8"	M22X1.5	14	31,1	27,0
1215722	C12421613-08240	Slip on nut	8	13,0	1/2"	M24X1.5	16	31,7	30,0
1215723	C12421613-10300	Slip on nut	10	16,0	5/8"	M30X2	20	36,5	36,0
1215724	C12421613-12300	Slip on nut	12	19,0	3/4"	M30X2	20	37,0	36,0
1215725	C12421613-12360	Slip on nut	12	19,0	3/4"	M36X2	25	40,2	46,0
1230389	C12421613-16360	Slip on nut	16	25,0	1"	M36X2	25	41,0	46,0
1215726	C12421613-16420	Slip on nut	16	25,0	1"	M42X2	30	43,1	50,0
1215727	C12421613-20420	Slip on nut	20	32,0	1 1/4"	M42X2	30	44,7	50,0
1215728	C12421613-20520	Slip on nut	20	32,0	1 1/4"	M52X2	38	48,1	60,0

// C12421643

45° Metric Female 24° Cone with O-Ring
ISO 8434-1 - Heavy Series
DKOS 45
Solid one piece

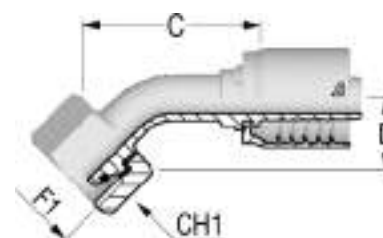

Item Code	Product Code	Nut Type	ID (Dash)	ID (mm)	ID (in)	F1	OD1	C (mm)	D Drop (mm)	CH1 (mm)
1215729	C12421643-06200	Slip on nut	6	10,0	3/8"	M20X1.5	12	50,6	20,0	24,0
1233033	C12421643-06220	Slip on nut	6	10,0	3/8"	M22X1.5	14	52,9	21,0	27,0
1215730	C12421643-08240	Slip on nut	8	13,0	1/2"	M24X1.5	16	55,8	21,5	30,0
1215731	C12421643-10300	Slip on nut	10	16,0	5/8"	M30X2	20	66,3	30,0	36,0
1215732	C12421643-12360	Slip on nut	12	19,0	3/4"	M36X2	25	69,5	33,0	46,0
1215733	C12421643-16420	Slip on nut	16	25,0	1"	M42X2	30	110,3	40,5	50,0
1215734	C12421643-20520	Slip on nut	20	32,0	1 1/4"	M52X2	38	109,0	45,0	60,0

Design and dimensions shown may be changed without prior notice

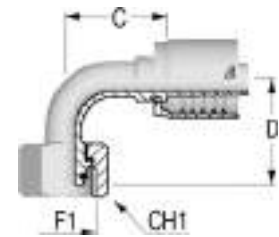
// C12421693**90° Metric Female 24° Cone with O-Ring****ISO 8434-1 - Heavy Series****DKOS 90****Solid one piece**

Item Code	Product Code	Nut Type	ID (Dash)	ID (mm)	ID (in)	F1	OD1	C (mm)	D Drop (mm)	CH1 (mm)
1215735	C12421693-06200	Slip on nut	6	10,0	3/8"	M20X1.5	12	34,3	38,5	24,0
1215736	C12421693-06220	Slip on nut	6	10,0	3/8"	M22X1.5	14	34,3	40,5	27,0
1215737	C12421693-08240	Slip on nut	8	13,0	1/2"	M24X1.5	16	39,8	41,5	30,0
1215738	C12421693-10300	Slip on nut	10	16,0	5/8"	M30X2	20	47,9	55,0	36,0
1215739	C12421693-12360	Slip on nut	12	19,0	3/4"	M36X2	25	50,6	59,5	46,0
1215740	C12421693-16420	Slip on nut	16	25,0	1"	M42X2	30	75,6	79,0	50,0
1215741	C12421693-20520	Slip on nut	20	32,0	1 1/4"	M52X2	38	94,0	92,0	60,0

// SAE INSERTS

// C12413010

SAE Male Solid - O-Ring Boss

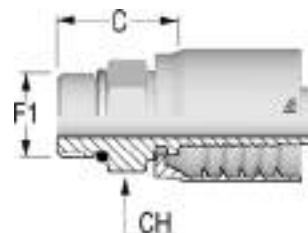

Item Code	Product Code	ID (Dash)	ID (mm)	ID (in)	F1 Dash	F1	C (mm)	CH (mm)
1233039	C12413010-06060	6	10,0	3/8"	6	9/16-18	23,3	19,0
1215653	C12413010-08080	8	13,0	1/2"	8	3/4-16	25,1	22,0
1233040	C12413010-08100	8	13,0	1/2"	10	7/8-14	27,6	27,0
1233041	C12413010-08120	8	13,0	1/2"	12	1 1/16-12	32,1	32,0
1233042	C12413010-10120	10	16,0	5/8"	12	1 1/16-12	32,1	32,0
1233043	C12413010-12100	12	19,0	3/4"	10	7/8-14	28,1	27,0
1215654	C12413010-12120	12	19,0	3/4"	12	1 1/16-12	32,6	32,0
1215655	C12413010-12160	12	19,0	3/4"	16	1 5/16-12	34,6	38,0
1215656	C12413010-16160	16	25,0	1"	16	1 5/16-12	35,4	38,0

Design and dimensions shown may be changed without prior notice

// JIC 37° INSERTS

// C12412510

JIC Male 37° Cone

AGJ

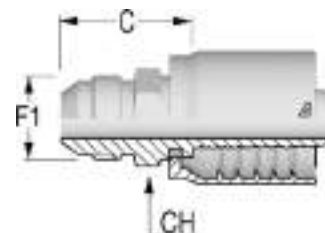

Item Code	Product Code	ID (Dash)	ID (mm)	ID (in)	F1 Dash	F1	C (mm)	CH (mm)
1215616	C12412510-06060	6	10,0	3/8"	6	9/16-18	26,3	17,0
1215617	C12412510-06080	6	10,0	3/8"	8	3/4-16	29,8	19,0
1215618	C12412510-08080	8	13,0	1/2"	8	3/4-16	30,6	19,0
1215619	C12412510-08100	8	13,0	1/2"	10	7/8-14	34,6	24,0
1215620	C12412510-08120	8	13,0	1/2"	12	1 1/16-12	37,1	27,0
1215621	C12412510-10100	10	16,0	5/8"	10	7/8-14	34,6	24,0
1215622	C12412510-10120	10	16,0	5/8"	12	1 1/16-12	37,1	27,0
1215623	C12412510-12120	12	19,0	3/4"	12	1 1/16-12	37,6	27,0
1215624	C12412510-12140	12	19,0	3/4"	14	1 3/16-12	40,1	32,0
1215625	C12412510-12160	12	19,0	3/4"	16	1 5/16-12	42,6	36,0
1215626	C12412510-16160	16	25,0	1"	16	1 5/16-12	43,4	36,0
1215627	C12412510-16200	16	25,0	1"	20	1 5/8-12	46,9	46,0
1215628	C12412510-20200	20	32,0	1 1/4"	20	1 5/8-12	48,5	46,0
1215630	C12412510-24240	24	38,0	1 1/2"	24	1 7/8-12	52,5	50,0

// C12422511

JIC Female 37° Seat

DKJ

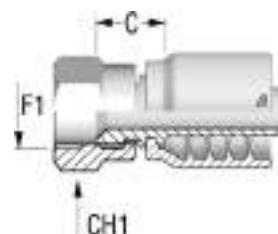

Item Code	Product Code	Nut Type	ID (Dash)	ID (mm)	ID (in)	F1 Dash	F1	C (mm)	CH1 (mm)
1215802	C12422511-06060	Crimped	6	10,0	3/8"	6	9/16-18	15,3	19,0
1233034	C12422511-06080	Crimped	6	10,0	3/8"	8	3/4-16	17,8	25,0
1230393	C12422511-08080	Crimped	8	13,0	1/2"	8	3/4-16	18,6	25,0
1215803	C12422511-08100	Crimped	8	13,0	1/2"	10	7/8-14	19,6	27,0
1215804	C12422511-08120	Crimped	8	13,0	1/2"	12	1 1/16-12	22,1	32,0
1215806	C12422511-10120	Crimped	10	16,0	5/8"	12	1 1/16-12	20,1	32,0
1215807	C12422511-12100	Crimped	12	19,0	3/4"	10	7/8-14	20,1	27,0
1215808	C12422511-12120	Crimped	12	19,0	3/4"	12	1 1/16-12	20,6	32,0
1215809	C12422511-12140	Crimped	12	19,0	3/4"	14	1 3/16-12	19,9	36,0
1233035	C12422511-12160	Crimped	12	19,0	3/4"	16	1 5/16-12	22,1	38,0
1230394	C12422511-16160	Crimped	16	25,0	1"	16	1 5/16-12	23,9	38,0
1233036	C12422512-16200	Thrust wire nut	16	25,0	1"	20	1 5/8-12	26,5	50,0
1215810	C12422512-20200	Thrust wire nut	20	32,0	1 1/4"	20	1 5/8-12	28,1	50,0
1233037	C12422512-20240	Thrust wire nut	20	32,0	1 1/4"	24	1 7/8-12	30,4	55,0
1215811	C12422512-24240	Thrust wire nut	24	38,0	1 1/2"	24	1 7/8-12	29,4	55,0
1215812	C12422512-32320	Thrust wire nut	32	51,0	2"	32	2 1/2-12	32,0	70,0

Image: insert with Crimped Nut.

// C12426511

**JIC Female 37° Seat with Stem Hexagon
DKJ**

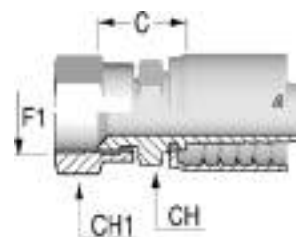

Item Code	Product Code	Nut Type	ID (Dash)	ID (mm)	ID (in)	F1 Dash	F1	C (mm)	CH (mm)	CH1 (mm)
1215874	C12426511-06060	Crimped	6	10,0	3/8"	6	9/16-18	21,3	17,0	19,0
1215875	C12426511-06080	Crimped	6	10,0	3/8"	8	3/4-16	24,8	19,0	25,0
1215876	C12426511-08060	Crimped	8	13,0	1/2"	6	9/16-18	23,1	19,0	19,0
1215877	C12426511-08080	Crimped	8	13,0	1/2"	8	3/4-16	25,6	19,0	25,0
1215878	C12426511-08100	Crimped	8	13,0	1/2"	10	7/8-14	26,6	22,0	27,0
1215879	C12426511-08120	Crimped	8	13,0	1/2"	12	1 1/16-12	28,1	25,0	32,0
1215880	C12426511-10080	Crimped	10	16,0	5/8"	8	3/4-16	26,6	24,0	25,0
1214172	C12426511-10100	Crimped	10	16,0	5/8"	10	7/8-14	27,6	24,0	27,0
1215881	C12426511-10120	Crimped	10	16,0	5/8"	12	1 1/16-12	28,1	25,0	32,0
1215883	C12426511-12120	Crimped	12	19,0	3/4"	12	1 1/16-12	28,6	27,0	32,0
1215885	C12426511-12160	Crimped	12	19,0	3/4"	16	1 5/16-12	32,1	32,0	38,0
1215886	C12426511-16120	Crimped	16	25,0	1"	12	1 1/16-12	31,4	32,0	32,0
1215887	C12426511-16160	Crimped	16	25,0	1"	16	1 5/16-12	32,9	32,0	38,0
1215888	C12426512-16200	Thrust wire nut	16	25,0	1"	20	1 5/8-12	37,5	41,0	50,0
1215889	C12426512-20200	Thrust wire nut	20	32,0	1 1/4"	20	1 5/8-12	39,1	41,0	50,0
1215890	C12426512-20240	Thrust wire nut	20	32,0	1 1/4"	24	1 7/8-12	43,4	50,0	55,0
1215891	C12426512-24240	Thrust wire nut	24	38,0	1 1/2"	24	1 7/8-12	43,4	50,0	55,0
1215892	C12426512-32320	Thrust wire nut	32	51,0	2"	32	2 1/2-12	49,0	65,0	70,0

Image: insert with Crimped Nut.

// C12426514 NEW

**JIC Female 37° Seat with double Hexagon
DKJ and solid nut**

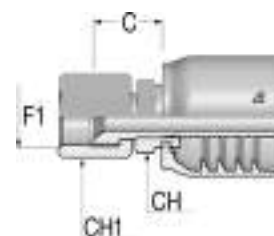

Item Code	Product Code	Nut Type	ID (Dash)	ID (mm)	ID (in)	F1 Dash	F1	C (mm)	CH (mm)	CH1 (mm)
1249661	C12426514-06060	Slip on nut	6	10,0	3/8"	6	9/16-18	22,1	17,0	19,0
1251030	C1242651K-06080	Slip on nut	6	10,0	3/8"	8	3/4-16	28,3	17,0	22,0
1249662	C12426514-08080	Slip on nut	8	13,0	1/2"	8	3/4-16	25,7	19,0	22,0
1249629	C1242651K-08100	Slip on nut	8	13,0	1/2"	10	7/8-14	29,0	22,0	27,0
1251031	C12426514-10100	Slip on nut	10	16,0	5/8"	10	7/8-14	29,2	24,0	27,0
1250371	C1242651K-10120	Slip on nut	10	16,0	5/8"	12	1 1/16-12	28,6	24,0	32,0
1249635	C12426514-12120	Slip on nut	12	19,0	3/4"	12	1 1/16-12	29,7	27,0	32,0
1251032	C1242651K-12160	Slip on nut	12	19,0	3/4"	16	1 5/16-12	36,1	32,0	41,0
1249563	C12426514-16160	Slip on nut	16	25,0	1"	16	1 5/16-12	33,9	32,0	41,0

Product Codes roots ending with K: insert with double hexagon knurled (ex. C1242651K).

Design and dimensions shown may be changed without prior notice

// C12422541-M
45° JIC Female 37° Seat
Medium Drop
DKJ 45M
Solid one piece

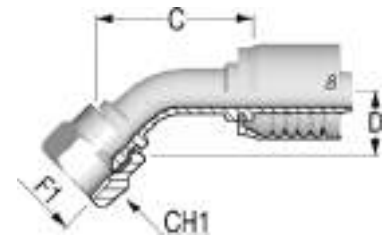

Item Code	Product Code	Nut Type	ID (Dash)	ID (mm)	ID (in)	F1 Dash	F1	C (mm)	D Drop (mm)	CH1 (mm)
1215813	C12422541-0606M	Crimped	6	10,0	3/8"	6	9/16-18	46,3	11,0	19,0
1215814	C12422541-0608M	Crimped	6	10,0	3/8"	8	3/4-16	47,2	15,0	25,0
1215815	C12422541-0808M	Crimped	8	13,0	1/2"	8	3/4-16	51,6	15,0	25,0
1215816	C12422541-0810M	Crimped	8	13,0	1/2"	10	7/8-14	50,7	16,0	27,0
1215817	C12422541-0812M	Crimped	8	13,0	1/2"	12	1 1/16-12	57,0	21,0	32,0
1215818	C12422541-1010M	Crimped	10	16,0	5/8"	10	7/8-14	62,2	19,0	27,0
1230395	C12422541-1012M	Crimped	10	16,0	5/8"	12	1 1/16-12	68,6	21,0	32,0
1215819	C12422541-1212M	Crimped	12	19,0	3/4"	12	1 1/16-12	67,5	21,0	32,0
1215821	C12422541-1216M	Crimped	12	19,0	3/4"	16	1 5/16-12	71,4	26,0	38,0
1215822	C12422541-1616M	Crimped	16	25,0	1"	16	1 5/16-12	79,4	24,0	38,0
1215824	C12422542-1620M	Thrust wire nut	16	25,0	1"	20	1 5/8-12	83,8	37,0	50,0
1215825	C12422542-2020M	Thrust wire nut	20	32,0	1 1/4"	20	1 5/8-12	97,1	37,0	50,0
1215827	C12422542-2424M	Thrust wire nut	24	38,0	1 1/2"	24	1 7/8-12	112,7	43,0	55,0
1215828	C12422542-3232M	Thrust wire nut	32	51,0	2"	32	2 1/2-12	159,9	67,0	70,0

Image: insert with Crimped Nut.

// C12426544-M NEW

45° JIC Female 37° Seat
Medium Drop
DKJ 45M
Solid nut and double Hexagon crimped

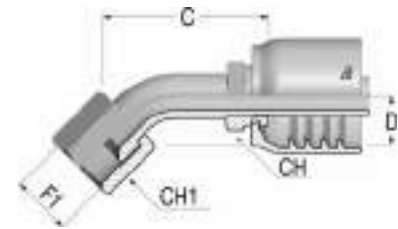

Item Code	Product Code	Nut Type	ID (Dash)	ID (mm)	ID (in)	F1 Dash	F1	C (mm)	D Drop (mm)	CH (mm)	CH1 (mm)
1253069	C12426544-0606M	Slip on nut	6	10,0	3/8"	6	9/16-18	46,0	11,0	17,0	19,0
1253070	C12426544-0608M	Slip on nut	6	10,0	3/8"	8	3/4-16	47,0	15,0	17,0	22,0
1253071	C12426544-0808M	Slip on nut	8	13,0	1/2"	8	3/4-16	52,0	15,0	19,0	22,0
1253072	C12426544-0810M	Slip on nut	8	13,0	1/2"	10	7/8-14	51,0	16,0	19,0	27,0
1253073	C12426544-1010M	Slip on nut	10	16,0	5/8"	10	7/8-14	65,0	16,0	24,0	27,0
1253074	C12426544-1012M	Slip on nut	10	16,0	5/8"	12	1 1/16-12	69,0	21,0	24,0	32,0
1252492	C12426544-1212M	Slip on nut	12	19,0	3/4"	12	1 1/16-12	67,0	21,0	27,0	32,0
1253075	C12426544-1216M	Slip on nut	12	19,0	3/4"	16	1 5/16-12	71,0	24,0	27,0	41,0
1253076	C12426544-1616M	Slip on nut	16	25,0	1"	16	1 5/16-12	80,0	24,0	32,0	41,0

// C12422591-S

90° JIC Female 37° Seat

Short Drop

DKJ 90S

Solid one piece

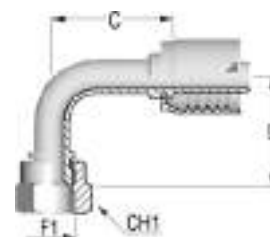

Item Code	Product Code	Nut Type	ID (Dash)	ID (mm)	ID (in)	F1 Dash	F1	C (mm)	D Drop (mm)	CH1 (mm)
1230396	C12422591-0812S	Crimped	8	13,0	1/2"	12	1 1/16-12	37,3	46,0	32,0
1215850	C12422591-1212S	Crimped	12	19,0	3/4"	12	1 1/16-12	58,2	46,0	32,0
1215854	C12422591-1216S	Crimped	12	19,0	3/4"	16	1 5/16-12	53,6	53,0	38,0
1215857	C12422591-1616S	Crimped	16	25,0	1"	16	1 5/16-12	74,0	56,0	38,0

// C12426594-S *NEW*

90° JIC Female 37° Seat

Short Drop

Solid Nut and double Hexagon crimped

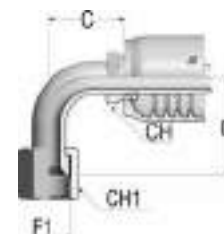

Item Code	Product Code	Nut Type	ID (Dash)	ID (mm)	ID (in)	F1 Dash	F1	C (mm)	D Drop (mm)	CH (mm)	CH1 (mm)
1253079	C12426594-0606S	Slip on nut	6	10,0	3/8"	6	9/16-18	40,0	24,5	17,0	19,0
1253081	C12426594-0608S	Slip on nut	6	10,0	3/8"	8	3/4-16	49,0	29,0	17,0	22,0
1253084	C12426594-0808S	Slip on nut	8	13,0	1/2"	8	3/4-16	48,0	29,0	19,0	22,0
1253087	C12426594-0810S	Slip on nut	8	13,0	1/2"	10	7/8-14	46,0	32,0	19,0	27,0
1253091	C12426594-1012S	Slip on nut	10	16,0	5/8"	12	1 1/16-12	48,0	48,0	24,0	32,0
1252212	C12426594-1212S	Slip on nut	12	19,0	3/4"	12	1 1/16-12	58,2	46,0		32,0
1253104	C12422593-1216S	Slip on nut	12	19,0	3/4"	16	1 5/16-12	53,5	53,0		41,0
1253095	C12426594-1616S	Slip on nut	16	25,0	1"	16	1 5/16-12	74,0	56,0	32,0	41,0

Product Codes roots ending with 3: insert with turned ring (ex. C12422593).

Design and dimensions shown may be changed without prior notice

// C12422591-M
90° JIC Female 37° Seat
Medium Drop
DKJ 90M
Solid one piece

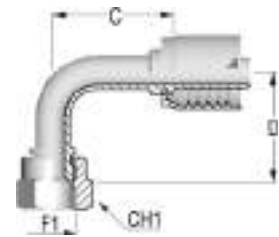

Item Code	Product Code	Nut Type	ID (Dash)	ID (mm)	ID (in)	F1 Dash	F1	C (mm)	D Drop (mm)	CH1 (mm)
1215830	C12422591-0606M	Crimped	6	10,0	3/8"	6	9/16-18	31,3	35,0	19,0
1215833	C12422591-0608M	Crimped	6	10,0	3/8"	8	3/4-16	39,5	41,0	25,0
1215836	C12422591-0808M	Crimped	8	13,0	1/2"	8	3/4-16	37,2	40,0	25,0
1215839	C12422591-0810M	Crimped	8	13,0	1/2"	10	7/8-14	43,3	47,0	27,0
1233038	C12422591-0812M	Crimped	8	13,0	1/2"	12	1 1/16-12	42,8	58,0	32,0
1215842	C12422591-1010M	Crimped	10	16,0	5/8"	10	7/8-14	49,4	48,0	27,0
1215845	C12422591-1012M	Crimped	10	16,0	5/8"	12	1 1/16-12	47,9	58,0	32,0
1215849	C12422591-1212M	Crimped	12	19,0	3/4"	12	1 1/16-12	52,4	54,0	32,0
1215853	C12422591-1216M	Crimped	12	19,0	3/4"	16	1 5/16-12	52,6	72,0	38,0
1215856	C12422591-1616M	Crimped	16	25,0	1"	16	1 5/16-12	72,6	71,5	38,0
1230398	C12422592-1620M	Thrust wire nut	16	25,0	1"	20	1 5/8-12	72,6	78,0	50,0
1215858	C12422592-2020M	Thrust wire nut	20	32,0	1 1/4"	20	1 5/8-12	82,4	78,0	50,0
1215860	C12422592-2424M	Thrust wire nut	24	38,0	1 1/2"	24	1 7/8-12	95,3	92,0	55,0

Image: insert with Crimped Nut.

// C12426594-M NEW

90° JIC Female 37° Seat
Medium Drop
Solid Nut and double Hexagon crimped

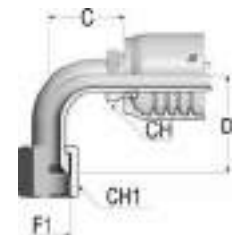

Item Code	Product Code	Nut Type	ID (Dash)	ID (mm)	ID (in)	F1 Dash	F1	C (mm)	D Drop (mm)	CH (mm)	CH1 (mm)
1253078	C12426594-0606M	Slip on nut	6	10,0	3/8"	6	9/16-18	31,5	38,0	17,0	19,0
1253080	C12422593-0608M	Slip on nut	6	10,0	3/8"	8	3/4-16	41,0	39,5		22,0
1253083	C12426594-0808M	Slip on nut	8	13,0	1/2"	8	3/4-16	37,0	41,0	19,0	22,0
1253086	C12426594-0810M	Slip on nut	8	13,0	1/2"	10	7/8-14	43,5	47,0	19,0	27,0
1253089	C12426594-1010M	Slip on nut	10	16,0	5/8"	10	7/8-14	49,5	47,0	24,0	27,0
1253090	C12426594-1012M	Slip on nut	10	16,0	5/8"	12	1 1/16-12	48,0	58,0	24,0	32,0
1252210	C12426594-1212M	Slip on nut	12	19,0	3/4"	12	1 1/16-12	52,4	54,0		32,0
1253103	C12422593-1216M	Slip on nut	12	19,0	3/4"	16	1 5/16-12	52,5	71,0		41,0
1253094	C12426594-1616M	Slip on nut	16	25,0	1"	16	1 5/16-12	73,0	71,0	32,0	41,0

Product Codes roots ending with 3: insert with turned ring (ex. C12A22593).

// C12422591-L
90° JIC Female 37° Seat
Long Drop
DKJ 90L
Solid one piece

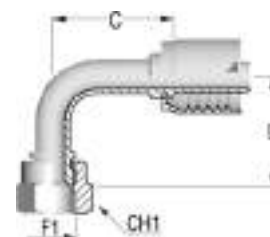

Item Code	Product Code	Nut Type	ID (Dash)	ID (mm)	ID (in)	F1 Dash	F1	C (mm)	D Drop (mm)	CH1 (mm)
1215829	C12422591-0606L	Crimped	6	10,0	3/8"	6	9/16-18	43,3	54,0	19,0
1215832	C12422591-0608L	Crimped	6	10,0	3/8"	8	3/4-16	46,8	64,0	25,0
1215835	C12422591-0808L	Crimped	8	13,0	1/2"	8	3/4-16	49,9	64,0	25,0
1215838	C12422591-0810L	Crimped	8	13,0	1/2"	10	7/8-14	37,3	65,0	27,0
1215841	C12422591-1010L	Crimped	10	16,0	5/8"	10	7/8-14	49,9	65,0	27,0
1215848	C12422591-1212L	Crimped	12	19,0	3/4"	12	1 1/16-12	54,1	95,0	32,0
1215855	C12422591-1616L	Crimped	16	25,0	1"	16	1 5/16-12	78,6	114,0	38,0

// C12426594-L NEW

90° JIC Female 37° Seat
Long Drop
Solid Nut and double Hexagon crimped

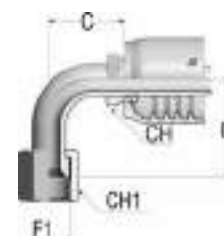

Item Code	Product Code	Nut Type	ID (Dash)	ID (mm)	ID (in)	F1 Dash	F1	C (mm)	D Drop (mm)	CH (mm)	CH1 (mm)
1253077	C12426594-0606L	Slip on nut	6	10,0	3/8"	6	9/16-18	43,5	54,0	17,0	19,0
1253100	C12422593-0608L	Slip on nut	6	10,0	3/8"	8	3/4-16	47,0	64,0		22,0
1253082	C12426594-0808L	Slip on nut	8	13,0	1/2"	8	3/4-16	50,0	64,0	19,0	22,0
1253085	C12426594-0810L	Slip on nut	8	13,0	1/2"	10	7/8-14	37,0	65,0	19,0	27,0
1253088	C12426594-1010L	Slip on nut	10	16,0	5/8"	10	7/8-14	50,0	70,0	24,0	27,0
1253092	C12426594-1212L	Slip on nut	12	19,0	3/4"	12	1 1/16-12	54,0	96,0	27,0	32,0
1253093	C12426594-1616L	Slip on nut	16	25,0	1"	16	1 5/16-12	79,0	114,0	32,0	41,0

Product Codes roots ending with 3: insert with turned ring (ex. C12422593).

Design and dimensions shown may be changed without prior notice

// NPTF INSERTS

// C12412810

NPTF Male 60° Seat
AGN

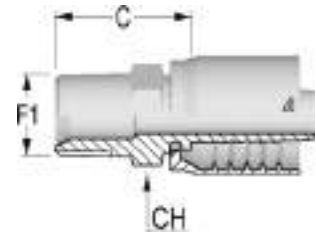

Item Code	Product Code	ID (Dash)	ID (mm)	ID (in)	F1 Dash	F1	C (mm)	CH (mm)
1215632	C12412810-06040	6	10,0	3/8"	4	1/4-18	26,8	17,0
1215633	C12412810-06060	6	10,0	3/8"	6	3/8-18	27,8	19,0
1215634	C12412810-06080	6	10,0	3/8"	8	1/2-14	31,3	22,0
1215635	C12412810-08060	8	13,0	1/2"	6	3/8-18	28,6	19,0
1215636	C12412810-08080	8	13,0	1/2"	8	1/2-14	32,1	22,0
1215637	C12412810-08120	8	13,0	1/2"	12	3/4-14	34,1	27,0
1215638	C12412810-10120	10	16,0	5/8"	12	3/4-14	34,1	27,0
1215639	C12412810-12080	12	19,0	3/4"	8	1/2-14	33,6	27,0
1215640	C12412810-12120	12	19,0	3/4"	12	3/4-14	34,6	27,0
1215641	C12412810-12160	12	19,0	3/4"	16	1-11 1/2	43,6	36,0
1215643	C12412810-16160	16	25,0	1"	16	1-11 1/2	44,4	36,0
1215644	C12412810-16200	16	25,0	1"	20	1 1/4-11 1/2	47,4	46,0
1215645	C12412810-20200	20	32,0	1 1/4"	20	1 1/4-11 1/2	49,0	46,0
1215646	C12412810-20240	20	32,0	1 1/4"	24	1 1/2-11 1/2	50,5	50,0
1215647	C12412810-24240	24	38,0	1 1/2"	24	1 1/2-11 1/2	50,5	50,0
1215648	C12412810-32320	32	51,0	2"	32	2-11 1/2	54,2	65,0

// C12422810

NPTF Female Solid

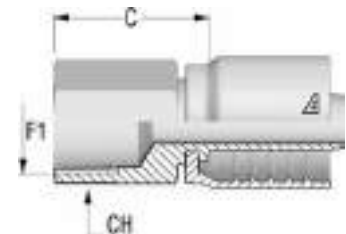

Item Code	Product Code	ID (Dash)	ID (mm)	ID (in)	F1 Dash	F1	C (mm)	CH (mm)
1215862	C12422810-12120	12	19,0	3/4"	12	3/4-14	38,1	32,0
1215863	C12422810-16160	16	25,0	1"	16	1-11 1/2	44,9	38,0

// C12412811
NPTF Male Swivel 60° Seat

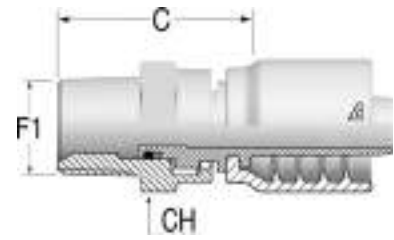

Item Code	Product Code	Nut Type	ID (Dash)	ID (mm)	ID (in)	F1 Dash	F1	C (mm)	CH (mm)
1215650	C12412811-08080	Crimped	8	13,0	1/2"	8	1/2-14	42,3	25,0
1215652	C12412811-16160	Crimped	16	25,0	1"	16	1-11 1/2	57,9	41,0

Design and dimensions shown may be changed without prior notice

// ORFS INSERTS

// C12412410

ORFS Male

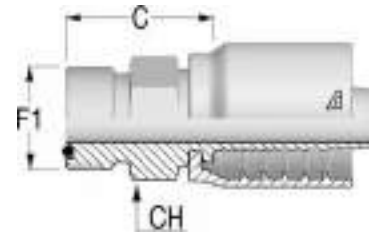

Item Code	Product Code	ID (Dash)	ID (mm)	ID (in)	F1 Dash	F1	C (mm)	CH (mm)
1215604	C12412410-06060	6	10,0	3/8"	6	11/16-16	24,3	19,0
1215606	C12412410-08080	8	13,0	1/2"	8	13/16-16	27,1	22,0
1215607	C12412410-08100	8	13,0	1/2"	10	1-14	30,6	27,0
1215611	C12412410-12120	12	19,0	3/4"	12	1 3/16-12	34,6	32,0
1215612	C12412410-12160	12	19,0	3/4"	16	1 7/16-12	38,1	41,0
1215613	C12412410-16160	16	25,0	1"	16	1 7/16-12	37,9	38,0
1215615	C12412410-20200	20	32,0	1 1/4"	20	1 11/16-12	41,5	46,0

// C12422414 **NEW**

ORFS Female with support Hexagon knurled

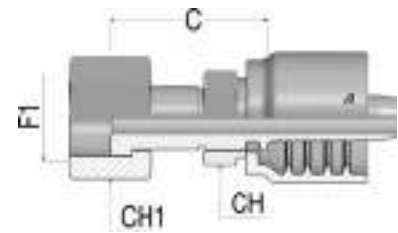

Item Code	Product Code	Nut Type	ID (Dash)	ID (mm)	ID (in)	F1 Dash	F1	C (mm)	CH (mm)	CH1 (mm)
1249426	C12422414-06060	Slip on nut	6	10,0	3/8"	6	11/16-16	32,3	17,0	22,0
1249427	C12422414-06080	Slip on nut	6	10,0	3/8"	8	13/16-16	39,3	22,0	24,0
1249428	C12422414-08080	Slip on nut	8	13,0	1/2"	8	13/16-16	40,5	22,0	24,0
1249429	C12422414-08100	Slip on nut	8	13,0	1/2"	10	1-14	43,0	24,0	30,0
1249430	C12422414-08120	Slip on nut	8	13,0	1/2"	12	1 3/16-12	42,1	30,0	36,0
1249431	C12422414-10100	Slip on nut	10	16,0	5/8"	10	1-14	45,0	24,0	30,0
1249432	C12422414-10120	Slip on nut	10	16,0	5/8"	12	1 3/16-12	42,1	30,0	36,0
1249433	C12422414-12120	Slip on nut	12	19,0	3/4"	12	1 3/16-12	42,6	30,0	36,0
1249434	C12422414-12160	Slip on nut	12	19,0	3/4"	16	1 7/16-12	50,6	36,0	41,0
1249435	C12422414-16160	Slip on nut	16	25,0	1"	16	1 7/16-12	51,4	36,0	41,0

// C12422443-S
45° ORFS Female
Short Drop
DK ORFS 45M
Solid one piece

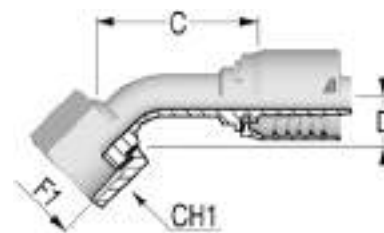

Item Code	Product Code	Nut Type	ID (Dash)	ID (mm)	ID (in)	F1 Dash	F1	C (mm)	D Drop (mm)	CH1 (mm)
1215759	C12422443-0606S	Slip on nut	6	10,0	3/8"	6	11/16-16	47,4	12,0	22,0
1215760	C12422443-0608S	Slip on nut	6	10,0	3/8"	8	13/16-16	51,2	15,0	24,0
1215757	C12422441-0808S	Crimped	8	13,0	1/2"	8	13/16-16	47,1	16,0	24,0
1215761	C12422443-0810S	Slip on nut	8	13,0	1/2"	10	1-14	50,4	16,5	30,0
1215762	C12422443-1010S	Slip on nut	10	16,0	5/8"	10	1-14	57,7	17,0	30,0
1230391	C12422443-1012S	Slip on nut	10	16,0	5/8"	12	1 3/16-12	63,1	21,0	36,0
1215763	C12422443-1212S	Slip on nut	12	19,0	3/4"	12	1 3/16-12	63,5	21,0	36,0
1215764	C12422443-1216S	Slip on nut	12	19,0	3/4"	16	1 7/16-12	70,7	24,0	41,0
1215765	C12422443-1616S	Slip on nut	16	25,0	1"	16	1 7/16-12	82,4	26,0	41,0
1215766	C12422443-1620S	Slip on nut	16	25,0	1"	20	1 11/16-12	85,4	26,0	50,0
1215767	C12422443-2020S	Slip on nut	20	32,0	1 1/4"	20	1 11/16-12	97,4	26,0	50,0
1215769	C12422443-2424S	Slip on nut	24	38,0	1 1/2"	24	2-12	104,4	28,0	60,0

Image: insert with Slip on Nut.

// C12422493-S
90° ORFS Female
Short Drop
DK ORFS 90S
Solid one piece

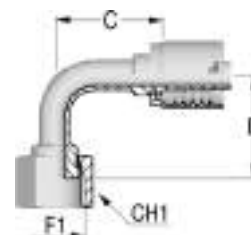

Item Code	Product Code	Nut Type	ID (Dash)	ID (mm)	ID (in)	F1 Dash	F1	C (mm)	D Drop (mm)	CH1 (mm)
1215777	C12422493-0606S	Slip on nut	6	10,0	3/8"	6	11/16-16	41,8	25,0	22,0
1215772	C12422491-0808S	Crimped	8	13,0	1/2"	8	13/16-16	39,8	29,0	24,0
1215781	C12422493-0810S	Slip on nut	8	13,0	1/2"	10	1-14	46,3	32,5	30,0
1233044	C12422493-1010S	Slip on nut	10	16,0	5/8"	10	1-14	52,3	32,5	30,0
1215786	C12422493-1212S	Slip on nut	12	19,0	3/4"	12	1 3/16-12	60,6	51,0	36,0
1215792	C12422493-1616S	Slip on nut	16	25,0	1"	16	1 7/16-12	80,0	58,0	41,0
1215795	C12422493-2020S	Slip on nut	20	32,0	1 1/4"	20	1 11/16-12	95,0	68,0	50,0

Image: insert with Slip on Nut.

Design and dimensions shown may be changed without prior notice

// C12422493-M

90° ORFS Female

Medium Drop

DK ORFS 90M

Solid one piece

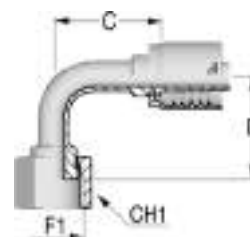

Item Code	Product Code	Nut Type	ID (Dash)	ID (mm)	ID (in)	F1 Dash	F1	C (mm)	D Drop (mm)	CH1 (mm)
1215776	C12422493-0606M	Slip on nut	6	10,0	3/8"	6	11/16-16	41,8	38,0	22,0
1215778	C12422493-0608M	Slip on nut	6	10,0	3/8"	8	13/16-16	43,8	41,0	24,0
1215771	C12422491-0808M	Crimped	8	13,0	1/2"	8	13/16-16	34,8	42,0	24,0
1215780	C12422493-0810M	Slip on nut	8	13,0	1/2"	10	1-14	48,3	47,0	30,0
1215782	C12422493-1010M	Slip on nut	10	16,0	5/8"	10	1-14	55,4	44,0	30,0
1230392	C12422493-1012M	Slip on nut	10	16,0	5/8"	12	1 3/16-12	55,4	58,0	36,0
1215785	C12422493-1212M	Slip on nut	12	19,0	3/4"	12	1 3/16-12	61,6	58,0	36,0
1215788	C12422493-1216M	Slip on nut	12	19,0	3/4"	16	1 7/16-12	65,6	71,0	41,0
1215791	C12422493-1616M	Slip on nut	16	25,0	1"	16	1 7/16-12	82,6	66,0	41,0
1215794	C12422493-2020M	Slip on nut	20	32,0	1 1/4"	20	1 11/16-12	97,0	78,0	50,0
1215800	C12422493-2424M	Slip on nut	24	38,0	1 1/2"	24	2-12	107,8	87,0	60,0

Image: insert with Slip on Nut.

// C12422493-L

90° ORFS Female

Long Drop

DK ORFS 90L

Solid one piece

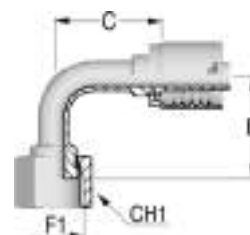

Item Code	Product Code	Nut Type	ID (Dash)	ID (mm)	ID (in)	F1 Dash	F1	C (mm)	D Drop (mm)	CH1 (mm)
1215775	C12422493-0606L	Slip on nut	6	10,0	3/8"	6	11/16-16	41,8	54,0	22,0
1215770	C12422491-0808L	Crimped	8	13,0	1/2"	8	13/16-16	38,3	64,0	24,0
1215779	C12422493-0810L	Slip on nut	8	13,0	1/2"	10	1-14	46,3	70,0	30,0
1233045	C12422493-1010L	Slip on nut	10	16,0	5/8"	10	1-14	55,4	70,0	30,0
1215784	C12422493-1212L	Slip on nut	12	19,0	3/4"	12	1 3/16-12	61,6	96,0	36,0
1215790	C12422493-1616L	Slip on nut	16	25,0	1"	16	1 7/16-12	82,6	114,0	41,0

Image: insert with Slip on Nut.

// SAE FLANGES

// C12443310

**Flange SAE 3000 psi J518 Code 61
SFL**

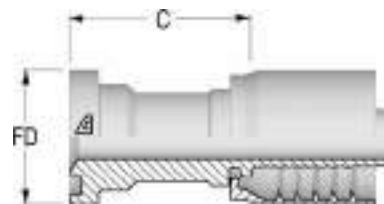

Item Code	Product Code	ID (Dash)	ID (mm)	ID (in)	F1 Dash	F1	FD (mm)	C (mm)	WP (psi)
1215898	C12443310-08080	8	13,0	1/2"	8	1/2	30,2	41,0	5000
1215899	C12443310-08120	8	13,0	1/2"	12	3/4	38,1	42,0	5000
1215901	C12443310-12120	12	19,0	3/4"	12	3/4	38,1	42,5	5000
1215902	C12443310-12160	12	19,0	3/4"	16	1	44,5	50,5	5000
1215903	C12443310-16160	16	25,0	1"	16	1	44,5	51,4	5000
1215904	C12443310-16200	16	25,0	1"	20	1 1/4	50,8	53,9	4000
1215906	C12443310-20200	20	32,0	1 1/4"	20	1 1/4	50,8	55,5	4000
1215907	C12443310-20240	20	32,0	1 1/4"	24	1 1/2	60,3	58,5	3000
1215908	C12443310-24240	24	38,0	1 1/2"	24	1 1/2	60,3	58,5	3000
1215910	C12443310-32320	32	51,0	2"	32	2	71,4	70,0	3000
1215911	C12443310-32400	32	51,0	2"	40	2 1/2	81,1	83,0	2500

Diameters from 1/2" include Whip Check Retention Nut.

// C12443340

**45° Flange SAE 3000 psi J518 Code 61
SFL 45
Solid one piece**

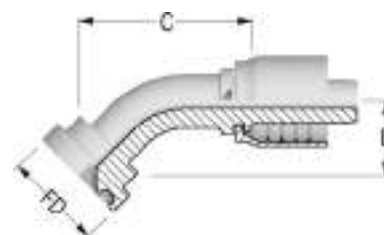

Item Code	Product Code	ID (Dash)	ID (mm)	ID (in)	F1 Dash	F1	FD (mm)	C (mm)	D Drop (mm)	WP (psi)
1215931	C12443340-08080	8	13,0	1/2"	8	1/2	30,2	52,9	22,0	5000
1215932	C12443340-08120	8	13,0	1/2"	12	3/4	38,1	60,3	26,0	5000
1215933	C12443340-12120	12	19,0	3/4"	12	3/4	38,1	73,7	32,0	5000
1215934	C12443340-12160	12	19,0	3/4"	16	1	44,5	77,9	29,0	5000
1215935	C12443340-16160	16	25,0	1"	16	1	44,5	82,7	33,5	5000
1215936	C12443340-16200	16	25,0	1"	20	1 1/4	50,8	82,2	36,0	4000
1215937	C12443340-20200	20	32,0	1 1/4"	20	1 1/4	50,8	95,1	37,5	4000
1215938	C12443340-20240	20	32,0	1 1/4"	24	1 1/2	60,3	104,1	40,0	3000
1215939	C12443340-24240	24	38,0	1 1/2"	24	1 1/2	60,3	116,7	48,0	3000
1215940	C12443340-24320	24	38,0	1 1/2"	32	2	71,4	135,6	55,5	3000
1215941	C12443340-32320	32	51,0	2"	32	2	71,4	140,8	47,5	3000

Design and dimensions shown may be changed without prior notice

// C12443390

90° Flange SAE 3000 psi J518 Code 61

SFL 90

Solid one piece



Item Code	Product Code	ID (Dash)	ID (mm)	ID (in)	F1 Dash	F1	FD (mm)	C (mm)	D Drop (mm)	WP (psi)
1215959	C12443390-08080	8	13,0	1/2"	8	1/2	30,2	45,8	42,0	5000
1215960	C12443390-08120	8	13,0	1/2"	12	3/4	38,1	45,3	51,0	5000
1215961	C12443390-12120	12	19,0	3/4"	12	3/4	38,1	59,7	58,0	5000
1215962	C12443390-12160	12	19,0	3/4"	16	1	44,5	66,2	64,5	5000
1215966	C12443390-16160	16	25,0	1"	16	1	44,5	70,6	67,0	5000
1215968	C12443390-16200	16	25,0	1"	20	1 1/4	50,8	73,6	71,0	4000
1215969	C12443390-16240	16	25,0	1"	24	1 1/2	60,3	93,1	75,0	3000
1215970	C12443390-20160	20	32,0	1 1/4"	16	1	44,5	94,4	65,0	5000
1215971	C12443390-20200	20	32,0	1 1/4"	20	1 1/4	50,8	88,0	84,0	4000
1215972	C12443390-20240	20	32,0	1 1/4"	24	1 1/2	60,3	91,5	87,5	3000
1215973	C12443390-24240	24	38,0	1 1/2"	24	1 1/2	60,3	104,8	91,0	3000
1215974	C12443390-24320	24	38,0	1 1/2"	32	2	71,4	104,8	115,0	3000
1215975	C12443390-32320	32	51,0	2"	32	2	71,4	129,3	130,0	3000

// C12443610

Flange SAE 6000 psi J518 Code 62

SFS

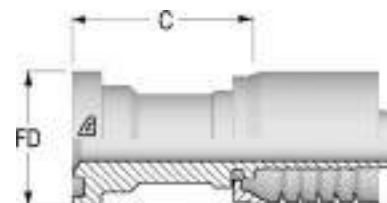

Item Code	Product Code	ID (Dash)	ID (mm)	ID (in)	F1 Dash	F1	FD (mm)	C (mm)	WP (psi)
1215977	C12443610-08080	8	13,0	1/2"	8	1/2	31,8	47,0	6000
1215978	C12443610-08120	8	13,0	1/2"	12	3/4	41,3	52,0	6000
1215979	C12443610-12120	12	19,0	3/4"	12	3/4	41,3	52,5	6000
1215980	C12443610-12160	12	19,0	3/4"	16	1	47,6	55,5	6000
1215981	C12443610-16120	16	25,0	1"	12	3/4	41,3	56,4	6000
1215982	C12443610-16160	16	25,0	1"	16	1	47,6	56,4	6000
1215983	C12443610-16200	16	25,0	1"	20	1 1/4	54,0	63,4	6000
1215984	C12443610-20200	20	32,0	1 1/4"	20	1 1/4	54,0	83,0	6000
1215985	C12443610-20240	20	32,0	1 1/4"	24	1 1/2	63,5	71,0	6000
1215986	C12443610-24240	24	38,0	1 1/2"	24	1 1/2	63,5	101,0	6000
1215988	C12443610-32320	32	51,0	2"	32	2	79,4	76,0	6000

Diametres from 1/2" include Whip Check Retention Nut.

// C12443640

45° Flange SAE 6000 psi J518 Code 62

SFS 45

Solid one piece

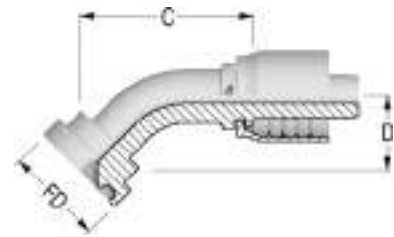

Item Code	Product Code	ID (Dash)	ID (mm)	ID (in)	F1 Dash	F1	FD (mm)	C (mm)	D Drop (mm)	WP (psi)
1215999	C12443640-08080	8	13,0	1/2"	8	1/2	31,8	56,5	23,0	6000
1216000	C12443640-08120	8	13,0	1/2"	12	3/4	41,3	79,9	30,5	6000
1216001	C12443640-12120	12	19,0	3/4"	12	3/4	41,3	84,1	31,0	6000
1216002	C12443640-12160	12	19,0	3/4"	16	1	47,6	80,0	33,5	6000
1216003	C12443640-16160	16	25,0	1"	16	1	47,6	96,7	36,0	6000
1216004	C12443640-16200	16	25,0	1"	20	1 1/4	54,0	96,1	39,0	6000
1216005	C12443640-20200	20	32,0	1 1/4"	20	1 1/4	54,0	108,6	40,0	6000
1216006	C12443640-20240	20	32,0	1 1/4"	24	1 1/2	63,5	114,8	45,5	6000
1216007	C12443640-24240	24	38,0	1 1/2"	24	1 1/2	63,5	122,9	45,0	6000
1216009	C12443640-32320	32	51,0	2"	32	2	79,4	156,6	60,0	6000

// C12443690

90° Flange SAE 6000 psi J518 Code 62

SFS 90

Solid one piece



Item Code	Product Code	ID (Dash)	ID (mm)	ID (in)	F1 Dash	F1	FD (mm)	C (mm)	D Drop (mm)	WP (psi)
1216015	C12443690-08080	8	13,0	1/2"	8	1/2	31,8	47,8	46,0	6000
1216016	C12443690-08120	8	13,0	1/2"	12	3/4	41,3	47,8	54,0	6000
1216017	C12443690-10120	10	16,0	5/8"	12	3/4	41,3	49,9	55,0	6000
1216018	C12443690-12120	12	19,0	3/4"	12	3/4	41,3	63,2	61,0	6000
1216019	C12443690-12160	12	19,0	3/4"	16	1	47,6	63,2	66,0	6000
1216021	C12443690-16160	16	25,0	1"	16	1	47,6	73,6	75,0	6000
1216022	C12443690-16200	16	25,0	1"	20	1 1/4	54,0	77,6	78,0	6000
1216023	C12443690-20200	20	32,0	1 1/4"	20	1 1/4	54,0	94,5	89,0	6000
1216024	C12443690-20240	20	32,0	1 1/4"	24	1 1/2	63,5	98,0	94,0	6000
1216025	C12443690-24240	24	38,0	1 1/2"	24	1 1/2	63,5	99,6	105,0	6000
1216027	C12443690-32320	32	51,0	2"	32	2	79,4	143,3	132,0	6000

Design and dimensions shown may be changed without prior notice

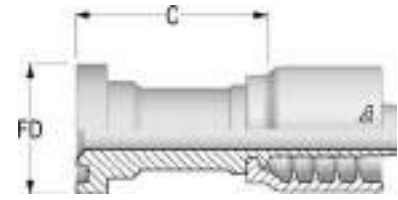
// C122 SAE FLANGES**// C12243310****Flange SAE 3000 psi J518 Code 61
SFL**

Item Code	Product Code	ID (Dash)	ID (mm)	ID (in)	F1 Dash	F1	FD (mm)	C (mm)	WP (psi)
1203199	C12243310-48480	48	76,0	3"	48	3	101,6	55,0	2000
1214123	C12243310-64640	64	102,0	4"	64	4	127,0	130,0	525

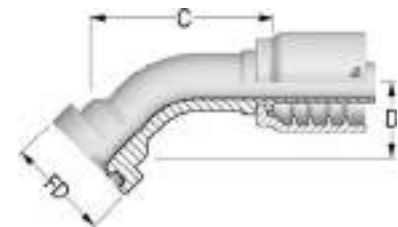
// C12243340**45° Flange SAE 3000 psi J518 Code 61
SFL 45
Solid one piece**

Item Code	Product Code	ID (Dash)	ID (mm)	ID (in)	F1 Dash	F1	FD (mm)	C (mm)	D Drop (mm)	WP (psi)
1214132	C12243340-48480	48	76,0	3"	48	3	101,6	140,0	54,0	2000
1214133	C12243340-64640	64	102,0	4"	64	4	127,0	264,5	161,0	525

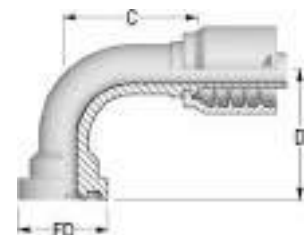
// C12243390**90° Flange SAE 3000 psi J518 Code 61
SFL 90
Solid one piece**

Item Code	Product Code	ID (Dash)	ID (mm)	ID (in)	F1 Dash	F1	FD (mm)	C (mm)	D Drop (mm)	WP (psi)
1203198	C12243390-48480	48	76,0	3"	48	3	101,6	149,3	140,0	2000
1214145	C12243390-64640	64	102,0	4"	64	4	127,0	187,4	190,0	525



// ALFACRIMP C126 - ONE PIECE - FITTINGS

// JIC 37° INSERTS.....	207	// SAE FLANGES.....	211
// NPTF INSERTS.....	208	// SUPERCAT FLANGES.....	213
// API INSERTS.....	209	// HAMMER UNION.....	215
// ORFS INSERTS.....	210		

Design and dimensions shown may be changed without prior notice

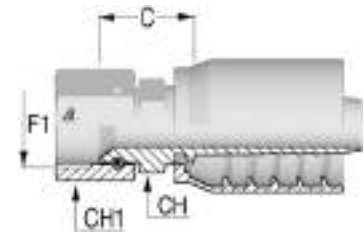
// JIC 37° INSERTS**// C12626512****JIC Female 37° Seat with Stem Hexagon
DKJ**

Item Code	Product Code	Nut Type	ID (Dash)	ID (mm)	ID (in)	F1 Dash	F1	C (mm)	CH (mm)	CH1 (mm)
1216077	C12626512-12120	Thrust wire nut	12	19,0	3/4"	12	1 1/16-12	30,2	27,0	32,0
1216080	C12626512-16160	Thrust wire nut	16	25,0	1"	16	1 5/16-12	38,0	36,0	38,0
1216082	C12626512-20200	Thrust wire nut	20	32,0	1 1/4"	20	1 5/8-12	43,1	41,0	50,0
1216084	C12626512-24240	Thrust wire nut	24	38,0	1 1/2"	24	1 7/8-12	49,4	50,0	55,0

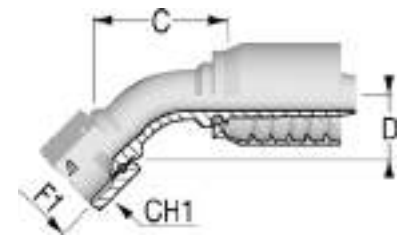
// C12622542**45° JIC Female 37° Seat
DKJ 45
Solid one piece**

Item Code	Product Code	Nut Type	ID (Dash)	ID (mm)	ID (in)	F1 Dash	F1	C (mm)	D Drop (mm)	CH1 (mm)
1216067	C12622542-12120	Thrust wire nut	12	19,0	3/4"	12	1 1/16-12	66,0	27,5	32,0
1216068	C12622542-16160	Thrust wire nut	16	25,0	1"	16	1 5/16-12	79,5	31,0	38,0
1216069	C12622542-20200	Thrust wire nut	20	32,0	1 1/4"	20	1 5/8-12	93,7	37,0	50,0
1216070	C12622542-24240	Thrust wire nut	24	38,0	1 1/2"	24	1 7/8-12	107,0	43,5	55,0

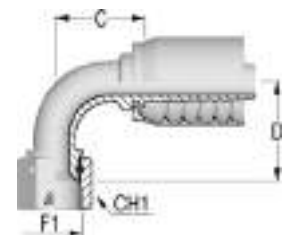
// C12622592**90° JIC Female 37° Seat
DKJ 90
Solid one piece**

Item Code	Product Code	Nut Type	ID (Dash)	ID (mm)	ID (in)	F1 Dash	F1	C (mm)	D Drop (mm)	CH1 (mm)
1216071	C12622592-12120	Thrust wire nut	12	19,0	3/4"	12	1 1/16-12	45,0	57,0	32,0
1216074	C12622592-16160	Thrust wire nut	16	25,0	1"	16	1 5/16-12	71,0	67,0	38,0
1216076	C12622592-20200	Thrust wire nut	20	32,0	1 1/4"	20	1 5/8-12	79,2	78,0	50,0
1214175	C12622592-24240	Thrust wire nut	24	38,0	1 1/2"	24	1 7/8-12	94,5	92,0	55,0

// NPTF INSERTS

// C12612810

NPTF Male 60° Seat

AGN

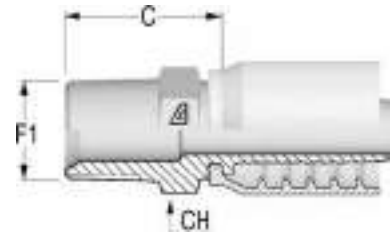

Item Code	Product Code	ID (Dash)	ID (mm)	ID (in)	F1 Dash	F1	C (mm)	CH (mm)
1216038	C12612810-12120	12	19,0	3/4"	12	3/4-14	35,5	27,0
1216039	C12612810-16160	16	25,0	1"	16	1-11 1/2	46,5	36,0
1216040	C12612810-20200	20	32,0	1 1/4"	20	1 1/4-11 1/2	52,0	46,0
1216041	C12612810-24240	24	38,0	1 1/2"	24	1 1/2-11 1/2	55,5	50,0

Design and dimensions shown may be changed without prior notice

// API INSERTS

// C1261281Z

API Male - Extra Long Hexagon

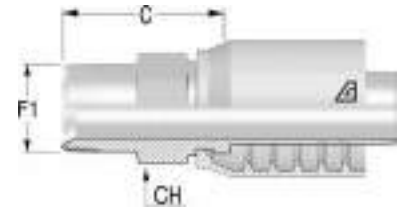

Item Code	Product Code	ID (Dash)	ID (mm)	ID (in)	F1 Dash	F1	C (mm)	CH (mm)
1216043	C1261281Z-32320	32	51,0	2"	32	2-11 1/2	114,5	65,0

// ORFS INSERTS

// C12622411

ORFS Female with Stem Hexagon

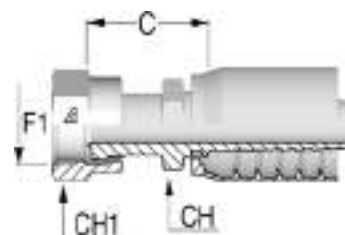

Item Code	Product Code	Nut Type	ID (Dash)	ID (mm)	ID (in)	F1 Dash	F1	C (mm)	CH (mm)	CH1 (mm)
1214173	C12622411-12120	Crimped	12	19,0	3/4"	12	1 3/16-12	40,0	30,0	36,0
1214174	C12622411-12160	Crimped	12	19,0	3/4"	16	1 7/16-12	43,0	36,0	41,0
1216051	C12622411-16160	Crimped	16	25,0	1"	16	1 7/16-12	47,0	36,0	41,0
1216052	C12622411-16200	Crimped	16	25,0	1"	20	1 11/16-12	49,0	46,0	50,0
1216053	C12622411-20200	Crimped	20	32,0	1 1/4"	20	1 11/16-12	47,2	46,0	50,0

210

FITTINGS

// C12622441

45° ORFS Female

DK ORFS 45

Solid one piece

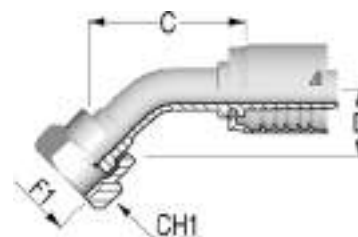

Item Code	Product Code	Nut Type	ID (Dash)	ID (mm)	ID (in)	F1 Dash	F1	C (mm)	D Drop (mm)	CH1 (mm)
1216055	C12622441-12120	Crimped	12	19,0	3/4"	12	1 3/16-12	77,7	26,0	36,0
1216056	C12622441-12160	Crimped	12	19,0	3/4"	16	1 7/16-12	68,4	28,0	41,0
1216057	C12622441-16160	Crimped	16	25,0	1"	16	1 7/16-12	114,0	28,0	41,0

// C12622491

90° ORFS Female

DK ORFS 90

Solid one piece

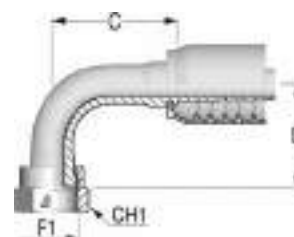

Item Code	Product Code	Nut Type	ID (Dash)	ID (mm)	ID (in)	F1 Dash	F1	C (mm)	D Drop (mm)	CH1 (mm)
1216059	C12622491-12120	Crimped	12	19,0	3/4"	12	1 3/16-12	64,2	58,0	36,0
1216060	C12622491-12160	Crimped	12	19,0	3/4"	16	1 7/16-12	66,2	58,0	41,0
1216061	C12622491-16160	Crimped	16	25,0	1"	16	1 7/16-12	75,2	66,0	41,0
1216062	C12622491-20200	Crimped	20	32,0	1 1/4"	20	1 11/16-12	91,7	81,0	50,0

Design and dimensions shown may be changed without prior notice

// SAE FLANGES

// C12643310

Flange SAE 3000 psi J518 Code 61
SFL

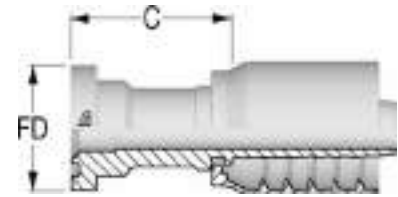

Item Code	Product Code	ID (Dash)	ID (mm)	ID (in)	F1 Dash	F1	FD (mm)	C (mm)	WP (psi)
1216086	C12643310-12120	12	19,0	3/4"	12	3/4	38,1	43,5	5000
1216087	C12643310-12160	12	19,0	3/4"	16	1	44,5	51,5	5000
1216088	C12643310-16160	16	25,0	1"	16	1	44,5	53,5	5000
1216089	C12643310-16200	16	25,0	1"	20	1 1/4	50,8	56,0	4000
1216091	C12643310-20200	20	32,0	1 1/4"	20	1 1/4	50,8	58,5	4000
1216093	C12643310-24240	24	38,0	1 1/2"	24	1 1/2	60,3	63,5	3000
1216094	C12643310-24320	24	38,0	1 1/2"	32	2	71,4	75,0	3000
1237793	C12R43310-32320	32	51,0	2"	32	2	71,4	85,0	3000

// C12643610

Flange SAE 6000 psi J518 Code 62
SFS

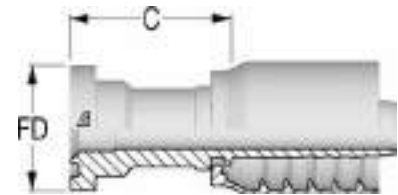

Item Code	Product Code	ID (Dash)	ID (mm)	ID (in)	F1 Dash	F1	FD (mm)	C (mm)	WP (psi)
1216120	C12643610-12120	12	19,0	3/4"	12	3/4	41,3	50,0	6000
1216121	C12643610-12160	12	19,0	3/4"	16	1	47,6	53,0	6000
1216123	C12643610-16160	16	25,0	1"	16	1	47,6	54,0	6000
1216124	C12643610-16200	16	25,0	1"	20	1 1/4	54,0	61,0	6000
1216125	C12643610-20200	20	32,0	1 1/4"	20	1 1/4	54,0	62,2	6000
1216126	C12643610-20240	20	32,0	1 1/4"	24	1 1/2	63,5	68,2	6000
1216127	C12643610-24240	24	38,0	1 1/2"	24	1 1/2	63,5	68,5	6000
1216128	C12643610-24320	24	38,0	1 1/2"	32	2	79,4	80,5	6000

// C12643640

45° Flange SAE 6000 psi J518 Code 62

SFS 45

Solid one piece

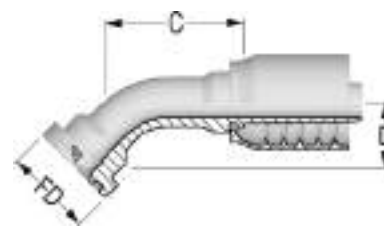

Item Code	Product Code	ID (Dash)	ID (mm)	ID (in)	F1 Dash	F1	FD (mm)	C (mm)	D Drop (mm)	WP (psi)
1216140	C12643640-12120	12	19,0	3/4"	12	3/4	41,3	72,1	30,0	6000
1216141	C12643640-12160	12	19,0	3/4"	16	1	47,6	76,8	33,0	6000
1216142	C12643640-16160	16	25,0	1"	16	1	47,6	94,8	38,5	6000
1216143	C12643640-16200	16	25,0	1"	20	1 1/4	54,0	105,3	44,0	6000
1216144	C12643640-20200	20	32,0	1 1/4"	20	1 1/4	54,0	102,0	41,0	6000
1216145	C12643640-20240	20	32,0	1 1/4"	24	1 1/2	63,5	111,7	48,0	6000
1216146	C12643640-24240	24	38,0	1 1/2"	24	1 1/2	63,5	136,3	48,0	6000
1216147	C12643640-24320	24	38,0	1 1/2"	32	2	79,4	129,1	55,0	6000

// C12643690

90° Flange SAE 6000 psi J518 Code 62

SFS 90

Solid one piece

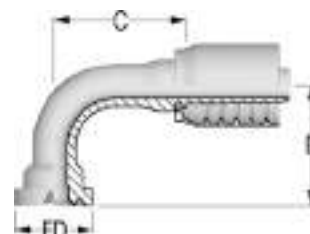

Item Code	Product Code	ID (Dash)	ID (mm)	ID (in)	F1 Dash	F1	FD (mm)	C (mm)	D Drop (mm)	WP (psi)
1216154	C12643690-12120	12	19,0	3/4"	12	3/4	41,3	61,2	64,0	6000
1216155	C12643690-12160	12	19,0	3/4"	16	1	47,6	61,2	66,0	6000
1216157	C12643690-16160	16	25,0	1"	16	1	47,6	70,4	74,0	6000
1216158	C12643690-16200	16	25,0	1"	20	1 1/4	54,0	77,2	85,0	6000
1216159	C12643690-20200	20	32,0	1 1/4"	20	1 1/4	54,0	88,2	91,0	6000
1216160	C12643690-20240	20	32,0	1 1/4"	24	1 1/2	63,5	92,9	103,5	6000
1216161	C12643690-24200	24	38,0	1 1/2"	20	1 1/4	54,0	105,0	85,0	6000
1216162	C12643690-24240	24	38,0	1 1/2"	24	1 1/2	63,5	106,3	109,0	6000
1216163	C12643690-24320	24	38,0	1 1/2"	32	2	79,4	106,5	121,5	6000

Design and dimensions shown may be changed without prior notice

// SUPERCAT FLANGES

// C12643910

Flange SUPERCAT

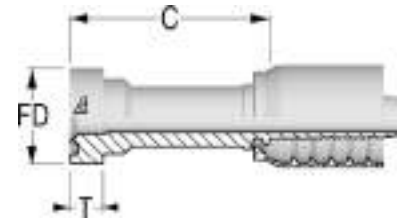

Item Code	Product Code	ID (Dash)	ID (mm)	ID (in)	F1 Dash	F1	FD (mm)	T (mm)	C (mm)	WP (psi)
1216165	C12643910-12120	12	19,0	3/4"	12	3/4	41,3	14,3	82,0	6000
1216166	C12643910-12160	12	19,0	3/4"	16	1	47,6	14,3	82,0	6000
1216167	C12643910-16160	16	25,0	1"	16	1	47,6	14,3	90,0	6000
1216168	C12643910-16200	16	25,0	1"	20	1 1/4	54,0	14,3	90,0	6000
1216169	C12643910-20200	20	32,0	1 1/4"	20	1 1/4	54,0	14,3	86,2	6000
1216170	C12643910-24240	24	38,0	1 1/2"	24	1 1/2	63,5	14,3	89,0	6000

// C12643930

30° Flange SUPERCAT

Solid one piece

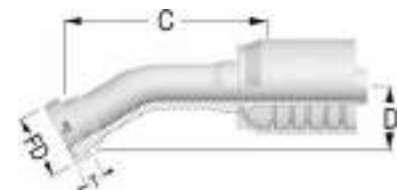

Item Code	Product Code	ID (Dash)	ID (mm)	ID (in)	F1 Dash	F1	FD (mm)	T (mm)	C (mm)	D Drop (mm)
1216173	C12643930-12120	12	19,0	3/4"	12	3/4	41,3	14,3	115,0	24,0
1216174	C12643930-12160	12	19,0	3/4"	16	1	47,6	14,3	118,0	26,5
1233049	C12643930-16160	16	25,0	1"	16	1	47,6	14,3	139,0	27,0
1233050	C12643930-16200	16	25,0	1"	20	1 1/4	54,0	14,3	137,0	25,5

// C12643940

45° Flange SUPERCAT

Solid one piece

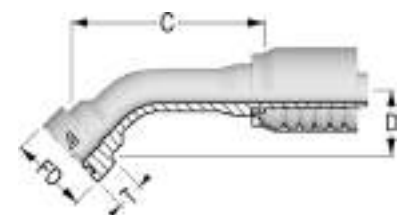

Item Code	Product Code	ID (Dash)	ID (mm)	ID (in)	F1 Dash	F1	FD (mm)	T (mm)	C (mm)	D Drop (mm)
1216177	C12643940-12120	12	19,0	3/4"	12	3/4	41,3	14,3	103,0	33,7
1216178	C12643940-12160	12	19,0	3/4"	16	1	47,6	14,3	87,4	35,8
1216179	C12643940-16160	16	25,0	1"	16	1	47,6	14,3	93,9	42,5
1216180	C12643940-16200	16	25,0	1"	20	1 1/4	54,0	14,3	95,4	40,0
1216181	C12643940-20200	20	32,0	1 1/4"	20	1 1/4	54,0	14,3	103,6	45,1
1245063	C12643940-32320	32	51,0	2"	32	2	79,4	14,3	179,0	63,0

// C12643960
60° Flange SUPERCAT
Solid one piece

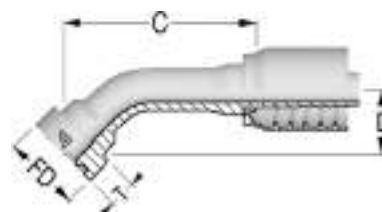

Item Code	Product Code	ID (Dash)	ID (mm)	ID (in)	F1 Dash	F1	FD (mm)	T (mm)	C (mm)	D Drop (mm)
1216182	C12643960-12120	12	19,0	3/4"	12	3/4	41,3	14,3	92,6	46,0
1216183	C12643960-12160	12	19,0	3/4"	16	1	47,6	14,3	95,6	48,5
1216184	C12643960-16160	16	25,0	1"	16	1	47,6	14,3	118,0	59,0
1216185	C12643960-16200	16	25,0	1"	20	1 1/4	54,0	14,3	118,0	57,0

// C126439Z0
67,5° Flange SUPERCAT
Solid one piece



Item Code	Product Code	ID (Dash)	ID (mm)	ID (in)	F1 Dash	F1	FD (mm)	T (mm)	C (mm)	D Drop (mm)
1216193	C126439Z0-12120	12	19,0	3/4"	12	3/4	41,3	14,3	86,1	51,8
1216194	C126439Z0-12160	12	19,0	3/4"	16	1	47,6	14,3	88,8	54,6
1233051	C126439Z0-16160	16	25,0	1"	16	1	47,6	14,3	111,0	67,0
1233052	C126439Z0-16200	16	25,0	1"	20	1 1/4	54,0	14,3	109,0	64,0
1233053	C126439Z0-20200	20	32,0	1 1/4"	20	1 1/4	54,0	14,3	119,3	70,6

// C12643990
90° Flange SUPERCAT
Solid one piece

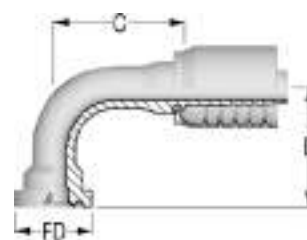

Item Code	Product Code	ID (Dash)	ID (mm)	ID (in)	F1 Dash	F1	FD (mm)	T (mm)	C (mm)	D Drop (mm)
1216188	C12643990-12120	12	19,0	3/4"	12	3/4	41,3	14,3	63,7	67,0
1216189	C12643990-12160	12	19,0	3/4"	16	1	47,6	14,3	65,2	70,0
1216190	C12643990-16160	16	25,0	1"	16	1	47,6	14,3	80,4	79,0
1216192	C12643990-16200	16	25,0	1"	20	1 1/4	54,0	14,3	75,4	82,5
1233054	C12643990-20200	20	32,0	1 1/4"	20	1 1/4	54,0	14,3	89,2	93,0
1245064	C12643990-32320	32	51,0	2"	32	2	79,4	14,3	152,0	138,5

Design and dimensions shown may be changed without prior notice

// HAMMER UNION

// C12613F13

Male Hammer Union Fig. 1502 Integral Fitting with Lug Nut

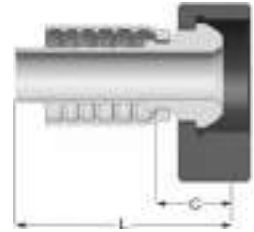

Item Code	Product Code	ID (Dash)	ID (mm)	ID (in)	C (mm)	L (mm)
1245065	C12613F13-32320	32	51,0	2"	71,0	185,5

// C12623F10

Female Hammer Union Fig. 1502 Integral Fitting with Rubber Ring

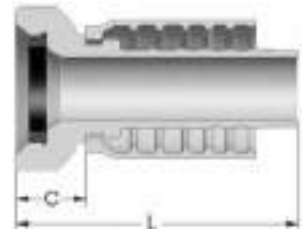

Item Code	Product Code	ID (Dash)	ID (mm)	ID (in)	C (mm)	L (mm)
1245061	C12623F10-32320	32	51,0	2"	67,5	182,0



// JIC 37° ADAPTERS

// MALE UNION.....	208	// SAE UNF.....	230
// MALE/FEMALE UNION.....	210	// NPTF.....	237
// BULKHEAD.....	213	// FLANGES.....	240
// BSPP-BSPT.....	216	// ACCESSORIES.....	243
// METRIC.....	226	// PLUG.....	244

Design and dimensions shown may be changed without prior notice

// MALE UNION

// R1A25M125M

Straight union JIC Male

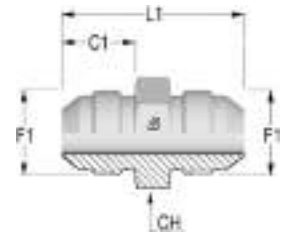

Item Code	Product Code	OD1	F1	C1 (mm)	L1 (mm)	CH (mm)
1203685	R1A25M125M-0404	1/4"	7/16-20	14,0	35,0	12,0
1203628	R1A25M125M-0505	5/16"	1/2-20	14,0	35,0	14,0
1203713	R1A25M125M-0606	3/8"	9/16-18	14,0	36,0	17,0
1203670	R1A25M125M-0808	1/2"	3/4-16	16,5	41,0	22,0
1203698	R1A25M125M-1010	5/8"	7/8-14	19,5	48,0	24,0
1203616	R1A25M125M-1212	3/4"	1 1/16-12	22,0	55,0	30,0
1216393	R1A25M125M-1414	7/8"	1 3/16-12	22,5	56,5	32,0
1203639	R1A25M125M-1616	1"	1 5/16-12	23,0	57,0	36,0
1203646	R1A25M125M-2020	1*1/4	1 5/8-12	24,5	61,5	46,0
1203653	R1A25M125M-2424	1*1/2	1 7/8-12	27,5	70,0	50,0

// R1A25M925M

90° union JIC Male

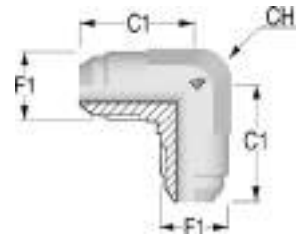

Item Code	Product Code	OD1	F1	C1 (mm)	CH (mm)
1203876	R1A25M925M-0404	1/4"	7/16-20	22,5	12,0
1203842	R1A25M925M-0505	5/16"	1/2-20	24,0	14,0
1203897	R1A25M925M-0606	3/8"	9/16-18	27,0	14,0
1203866	R1A25M925M-0808	1/2"	3/4-16	32,0	19,0
1203884	R1A25M925M-1010	5/8"	7/8-14	37,0	22,0
1203836	R1A25M925M-1212	3/4"	1 1/16-12	42,0	27,0
1216421	R1A25M925M-1414	7/8"	1 3/16-12	44,0	33,0
1203849	R1A25M925M-1616	1"	1 5/16-12	46,0	33,0
1203855	R1A25M925M-2020	1*1/4	1 5/8-12	52,5	41,0
1206334	R1A25M925M-2424	1*1/2	1 7/8-12	59,0	48,0

// R1A25MT25M

Branch Tee union JIC Male

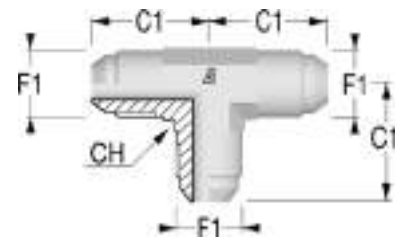

Item Code	Product Code	OD1	F1	C1 (mm)	CH (mm)
1203950	R1A25MT25M-0404	1/4"	7/16-20	22,5	12,0
1203945	R1A25MT25M-0505	5/16"	1/2-20	24,0	14,0
1203954	R1A25MT25M-0606	3/8"	9/16-18	27,0	14,0
1203948	R1A25MT25M-0808	1/2"	3/4-16	32,0	19,0
1203952	R1A25MT25M-1010	5/8"	7/8-14	37,0	22,0
1203944	R1A25MT25M-1212	3/4"	1 1/16-12	42,0	27,0
1216460	R1A25MT25M-1414	7/8"	1 3/16-12	44,0	33,0
1203947	R1A25MT25M-1616	1"	1 5/16-12	46,0	33,0
1205959	R1A25MT25M-2020	1"1/4	1 5/8-12	52,5	41,0
1206335	R1A25MT25M-2424	1"1/2	1 7/8-12	59,0	48,0

// R1A25MX25M

Cross union JIC Male

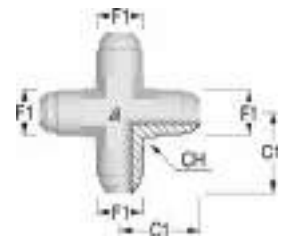

Item Code	Product Code	OD1	F1	C1 (mm)	CH (mm)
1205452	R1A25MX25M-1616	1"	1 5/16-12	46,0	33,0
1212824	R1A25MX25M-2424	1"1/2	1 7/8-12	59,0	48,0
1212823	R1A25MX25M-2020	1"1/4	1 5/8-12	52,5	41,0
1205453	R1A25MX25M-0808	1/2"	3/4-16	32,0	19,0
1206909	R1A25MX25M-0404	1/4"	7/16-20	22,5	12,0
1206835	R1A25MX25M-1212	3/4"	1 1/16-12	42,0	27,0
1205455	R1A25MX25M-0606	3/8"	9/16-18	27,0	14,0
1205451	R1A25MX25M-0505	5/16"	1/2-20	24,0	14,0
1205454	R1A25MX25M-1010	5/8"	7/8-14	37,0	22,0
1216494	R1A25MX25M-1414	7/8"	1 3/16-12	44,0	33,0

Design and dimensions shown may be changed without prior notice

// MALE/FEMALE UNION

// R1A253125M

Straight reducing JIC Female - Male

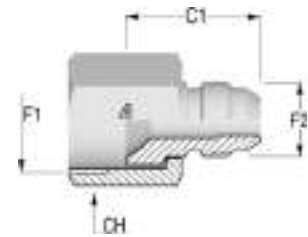

Item Code	Product Code	OD1	F1	F2	C1 (mm)	CH (mm)
1207357	R1A253125M-0604	3/8"	9/16-18	7/16-20	24,5	19,0
1207615	R1A253125M-0605	3/8"	9/16-18	1/2-20	25,0	19,0
1207358	R1A253125M-0804	1/2"	3/4-16	7/16-20	25,5	22,0
1207359	R1A253125M-0805	1/2"	3/4-16	1/2-20	25,5	22,0
1207360	R1A253125M-0806	1/2"	3/4-16	9/16-18	25,5	22,0
1207361	R1A253125M-1004	5/8"	7/8-14	7/16-20	26,5	27,0
1207362	R1A253125M-1006	5/8"	7/8-14	9/16-18	26,5	27,0
1207616	R1A253125M-1008	5/8"	7/8-14	3/4-16	32,5	27,0
1207363	R1A253125M-1204	3/4"	1 1/16-12	7/16-20	27,0	32,0
1207364	R1A253125M-1206	3/4"	1 1/16-12	9/16-18	27,0	32,0
1207365	R1A253125M-1208	3/4"	1 1/16-12	3/4-16	30,5	32,0
1207617	R1A253125M-1210	3/4"	1 1/16-12	7/8-14	34,5	32,0
1216344	R1A253125M-1412	7/8"	1 3/16-12	1 1/16-12	36,4	36,0
1216365	R1A253125M-1606	1"	1 5/16-12	9/16-18	28,5	41,0
1216366	R1A253125M-1608	1"	1 5/16-12	3/4-16	31,0	41,0
1208272	R1A253125M-1610	1"	1 5/16-12	7/8-14	34,0	41,0
1207367	R1A253125M-1612	1"	1 5/16-12	1 1/16-12	37,5	41,0
1213168	R1A253125M-1614	1"	1 5/16-12	1 3/16-12	39,5	38,0
1207366	R1A253125M-2012	1 1/4"	1 5/8-12	1 1/16-12	39,1	50,0
1207368	R1A253125M-2016	1 1/4"	1 5/8-12	1 5/16-12	40,0	50,0
1216367	R1A253125M-2416	1 1/2"	1 7/8-12	1 5/16-12	46,3	60,0
1207369	R1A253125M-2420	1 1/2"	1 7/8-12	1 5/8-12	47,8	60,0

// R1A25M4251

45° union JIC Male - Female

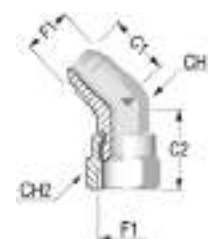

Item Code	Product Code	OD1	F1	C1 (mm)	C2 (mm)	CH (mm)	CH2 (mm)
1207343	R1A25M4251-0404	1/4"	7/16-20	18,5	23,7	12,0	16,0
1207342	R1A25M4251-0505	5/16"	1/2-20	20,0	25,5	14,0	17,0
1207341	R1A25M4251-0606	3/8"	9/16-18	21,5	28,5	14,0	19,0
1207344	R1A25M4251-0808	1/2"	3/4-16	24,5	32,7	19,0	25,0
1206944	R1A25M4251-1010	5/8"	7/8-14	28,0	36,7	22,0	27,0
1207345	R1A25M4251-1212	3/4"	1 1/16-12	32,5	38,3	27,0	32,0
1216410	R1A25M4251-1414	7/8"	1 3/16-12	35,4	43,0	33,0	36,0
1207346	R1A25M4251-1616	1"	1 5/16-12	36,5	44,6	33,0	38,0
1207347	R1A25M4252-2020	1 1/4"	1 5/8-12	40,5	51,4	41,0	50,0
1210765	R1A25M4252-2424	1 1/2"	1 7/8-12	45,0	57,1	48,0	55,0

// R1A25M9251

90° union JIC Male - Female



Item Code	Product Code	OD1	F1	C1 (mm)	C2 (mm)	CH (mm)	CH2 (mm)
1207266	R1A25M9251-0404	1/4"	7/16-20	22,5	25,2	12,0	16,0
1207267	R1A25M9251-0505	5/16"	1/2-20	24,5	27,0	14,0	17,0
1207268	R1A25M9251-0606	3/8"	9/16-18	27,0	32,0	14,0	19,0
1207269	R1A25M9251-0808	1/2"	3/4-16	32,5	35,2	19,0	25,0
1207270	R1A25M9251-1010	5/8"	7/8-14	36,5	41,5	22,0	27,0
1207271	R1A25M9251-1212	3/4"	1 1/16-12	42,0	44,3	27,0	32,0
1216420	R1A25M9251-1414	7/8"	1 3/16-12	45,5	48,0	33,0	36,0
1207272	R1A25M9251-1616	1"	1 5/16-12	46,0	50,6	33,0	38,0
1207273	R1A25M9252-2020	1*1/4	1 5/8-12	52,5	58,9	41,0	50,0
1207274	R1A25M9252-2424	1*1/2	1 7/8-12	59,0	65,6	48,0	55,0

// R1A25MT251

Branch Tee union JIC Male - Female

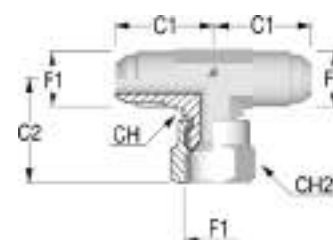

Item Code	Product Code	OD1	F1	C1 (mm)	C2 (mm)	CH (mm)	CH2 (mm)
1207304	R1A25MT251-0404	1/4"	7/16-20	22,5	22,5	12,0	16,0
1207305	R1A25MT251-0505	5/16"	1/2-20	24,0	24,0	14,0	17,0
1207306	R1A25MT251-0606	3/8"	9/16-18	27,0	27,0	14,0	19,0
1207307	R1A25MT251-0808	1/2"	3/4-16	32,0	32,0	19,0	25,0
1207308	R1A25MT251-1010	5/8"	7/8-14	36,5	36,5	22,0	27,0
1207309	R1A25MT251-1212	3/4"	1 1/16-12	42,0	42,0	27,0	32,0
1216459	R1A25MT251-1414	7/8"	1 3/16-12	45,5	45,5	33,0	36,0
1207310	R1A25MT251-1616	1"	1 5/16-12	46,0	46,0	33,0	38,0
1207311	R1A25MT252-2020	1*1/4	1 5/8-12	52,5	52,5	41,0	50,0
1207312	R1A25MT252-2424	1*1/2	1 7/8-12	59,0	59,0	48,0	50,0

Design and dimensions shown may be changed without prior notice

// R1A25ML251

Run Tee union JIC Male - Female

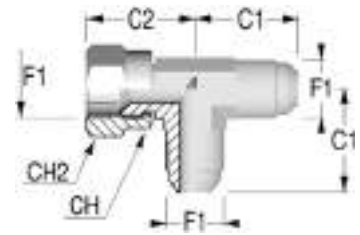

Item Code	Product Code	OD1	F1	C1 (mm)	C2 (mm)	CH (mm)	CH2 (mm)
1207283	R1A25ML251-0404	1/4"	7/16-20	22,5	25,2	12,0	16,0
1207284	R1A25ML251-0505	5/16"	1/2-20	24,0	27,0	14,0	17,0
1207285	R1A25ML251-0606	3/8"	9/16-18	27,0	32,0	14,0	19,0
1207286	R1A25ML251-0808	1/2"	3/4-16	32,0	35,2	19,0	25,0
1207287	R1A25ML251-1010	5/8"	7/8-14	36,5	41,5	22,0	27,0
1207288	R1A25ML251-1212	3/4"	1 1/16-12	42,0	44,3	27,0	32,0
1216434	R1A25ML251-1414	7/8"	1 3/16-12	45,5	46,5	33,0	36,0
1207289	R1A25ML251-1616	1"	1 5/16-12	46,0	50,5	33,0	38,0
1207290	R1A25ML252-2020	1" 1/4	1 5/8-12	52,5	59,0	41,0	50,0
1207291	R1A25ML252-2424	1" 1/2	1 7/8-12	59,0	65,6	48,0	55,0

// BULKHEAD

// R1A25M125T

Straight union JIC Bulkhead

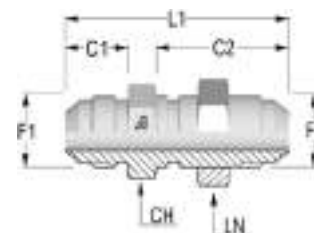

Item Code	Product Code	OD1	F1	C1 (mm)	C2 (mm)	L1 (mm)	CH (mm)	LN (mm)
1203686	R1A25M125T-0404	1/4"	7/16-20	14,0	30,5	52,5	17,0	17,0
1203629	R1A25M125T-0505	5/16"	1/2-20	14,0	30,5	52,5	19,0	19,0
1203714	R1A25M125T-0606	3/8"	9/16-18	14,0	32,5	55,5	22,0	22,0
1203671	R1A25M125T-0808	1/2"	3/4-16	16,5	36,5	62,0	24,0	24,0
1203699	R1A25M125T-1010	5/8"	7/8-14	19,5	40,0	69,5	30,0	30,0
1203617	R1A25M125T-1212	3/4"	1 1/16-12	22,0	44,5	78,5	36,0	36,0
1216394	R1A25M125T-1414	7/8"	1 3/16-12	22,5	44,5	79,2	38,0	41,0
1203640	R1A25M125T-1616	1"	1 5/16-12	23,0	44,5	80,0	41,0	41,0
1203647	R1A25M125T-2020	1 1/4"	1 5/8-12	24,5	45,5	84,0	50,0	50,0
1211675	R1A25M125T-2424	1 1/2"	1 7/8-12	27,5	46,0	89,5	55,0	55,0

// R1A25M425T

45° union JIC Bulkhead

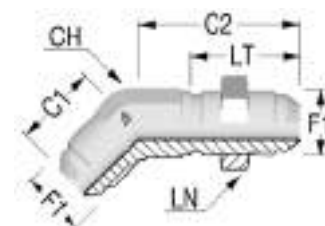

Item Code	Product Code	OD1	F1	C1 (mm)	C2 (mm)	LT (mm)	CH (mm)	LN (mm)
1210766	R1A25M425T-0404	1/4"	7/16-20	18,5	39,0	25,9	12,0	17,0
1211706	R1A25M425T-0505	5/16"	1/2-20	19,5	42,0	25,9	14,0	19,0
1208045	R1A25M425T-0606	3/8"	9/16-18	20,0	42,7	27,7	14,0	22,0
1210767	R1A25M425T-0808	1/2"	3/4-16	25,0	49,5	31,8	19,0	24,0
1210768	R1A25M425T-1010	5/8"	7/8-14	28,0	55,0	35,3	22,0	30,0
1210769	R1A25M425T-1212	3/4"	1 1/16-12	32,5	62,0	39,6	27,0	36,0
1216411	R1A25M425T-1414	7/8"	1 3/16-12	35,0	63,5	39,6	33,0	38,0
1210770	R1A25M425T-1616	1"	1 5/16-12	37,5	65,0	39,6	33,0	41,0
1211707	R1A25M425T-2020	1 1/4"	1 5/8-12	40,0	67,5	40,9	41,0	50,0
1211708	R1A25M425T-2424	1 1/2"	1 7/8-12	45,0	68,0	41,1	48,0	55,0

Design and dimensions shown may be changed without prior notice

// R1A25M925T

90° union JIC Bulkhead

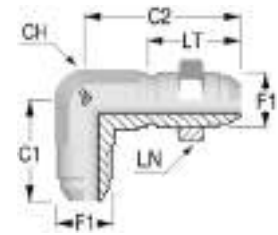

Item Code	Product Code	OD1	F1	C1 (mm)	C2 (mm)	LT (mm)	CH (mm)	LN (mm)
1205564	R1A25M925T-0404	1/4"	7/16-20	24,5	40,5	25,9	12,0	17,0
1206405	R1A25M925T-0505	5/16"	1/2-20	27,0	43,5	25,9	14,0	19,0
1203898	R1A25M925T-0606	3/8"	9/16-18	27,5	46,0	27,7	14,0	22,0
1203867	R1A25M925T-0808	1/2"	3/4-16	34,5	53,5	31,8	19,0	24,0
1203885	R1A25M925T-1010	5/8"	7/8-14	39,5	60,5	35,3	22,0	30,0
1206783	R1A25M925T-1212	3/4"	1 1/16-12	45,0	68,0	39,6	27,0	36,0
1216422	R1A25M925T-1414	7/8"	1 3/16-12	47,0	69,0	39,6	33,0	38,0
1211735	R1A25M925T-1616	1"	1 5/16-12	49,5	71,0	39,6	33,0	41,0
1211736	R1A25M925T-2020	1"1/4	1 5/8-12	55,0	79,0	40,9	41,0	50,0
1208117	R1A25M925T-2424	1"1/2	1 7/8-12	59,5	87,0	41,1	48,0	55,0

// R1A25MT25T

Branch Tee union JIC Bulkhead

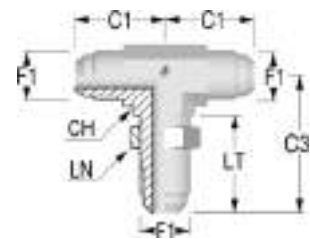

Item Code	Product Code	OD1	F1	C1 (mm)	C3 (mm)	LT (mm)	CH (mm)	LN (mm)
1208139	R1A25MT25T-0404	1/4"	7/16-20	24,5	40,5	25,9	12,0	17,0
1210747	R1A25MT25T-0505	5/16"	1/2-20	27,0	43,5	25,9	14,0	19,0
1210748	R1A25MT25T-0606	3/8"	9/16-18	27,5	46,0	27,7	14,0	22,0
1205586	R1A25MT25T-0808	1/2"	3/4-16	34,5	53,5	31,8	19,0	24,0
1211637	R1A25MT25T-1010	5/8"	7/8-14	39,5	60,5	35,3	22,0	30,0
1211638	R1A25MT25T-1212	3/4"	1 1/16-12	45,0	68,0	39,6	27,0	36,0
1216462	R1A25MT25T-1414	7/8"	1 3/16-12	49,0	69,0	39,6	33,0	38,0
1212775	R1A25MT25T-1616	1"	1 5/16-12	49,5	71,0	39,6	33,0	41,0
1208225	R1A25MT25T-2020	1"1/4	1 5/8-12	55,0	79,0	40,9	41,0	50,0
1212776	R1A25MT25T-2424	1"1/2	1 7/8-12	59,5	87,0	41,1	48,0	55,0

// R1A25ML25T

Run Tee union JIC Bulkhead

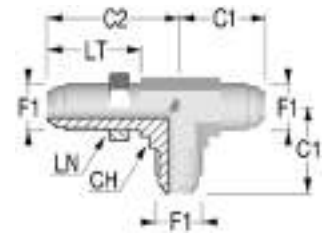

Item Code	Product Code	OD1	F1	C1 (mm)	C2 (mm)	LT (mm)	CH (mm)	LN (mm)
1211617	R1A25ML25T-0404	1/4"	7/16-20	24,5	40,5	25,9	12,0	17,0
1211618	R1A25ML25T-0505	5/16"	1/2-20	27,0	43,5	25,9	14,0	19,0
1206974	R1A25ML25T-0606	3/8"	9/16-18	27,5	46,0	27,7	14,0	22,0
1211619	R1A25ML25T-0808	1/2"	3/4-16	34,5	53,5	32,0	19,0	24,0
1210743	R1A25ML25T-1010	5/8"	7/8-14	39,5	60,5	35,3	22,0	30,0
1211620	R1A25ML25T-1212	3/4"	1 1/16-12	45,0	68,0	39,6	27,0	36,0
1216435	R1A25ML25T-1414	7/8"	1 3/16-12	47,0	69,0	39,6	33,0	38,0
1212713	R1A25ML25T-1616	1"	1 5/16-12	49,5	71,0	39,6	33,0	41,0
1212714	R1A25ML25T-2020	1"1/4	1 5/8-12	55,0	79,0	40,9	41,0	50,0
1212715	R1A25ML25T-2424	1"1/2	1 7/8-12	59,5	87,0	41,1	48,0	55,0

Design and dimensions shown may be changed without prior notice

// BSPP-BSPT

// R1A25M105M

Straight connector

JIC Male - BSP 60° Male

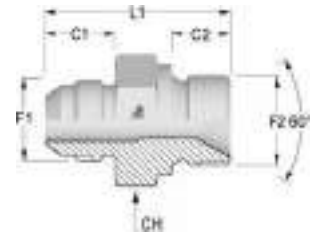

Item Code	Product Code	OD1	F1	F2	C1 (mm)	C2 (mm)	L1 (mm)	CH (mm)
1212826	R1A25M105M-0402	1/4"	7/16-20	1/8-28	14,0	9,5	29,0	14,0
1212827	R1A25M105M-0404	1/4"	7/16-20	1/4-19	14,0	13,0	34,0	19,0
1212828	R1A25M105M-0406	1/4"	7/16-20	3/8-19	14,0	15,5	35,5	22,0
1212829	R1A25M105M-0408	1/4"	7/16-20	1/2-14	14,0	17,0	40,0	27,0
1212830	R1A25M105M-0502	5/16"	1/2-20	1/8-28	14,0	9,5	29,0	14,0
1212831	R1A25M105M-0504	5/16"	1/2-20	1/4-19	14,0	13,0	32,0	19,0
1212832	R1A25M105M-0604	3/8"	9/16-18	1/4-19	14,0	13,0	34,0	19,0
1212833	R1A25M105M-0606	3/8"	9/16-18	3/8-19	14,0	15,5	35,5	22,0
1212834	R1A25M105M-0608	3/8"	9/16-18	1/2-14	14,0	17,0	41,0	27,0
1212835	R1A25M105M-0804	1/2"	3/4-16	1/4-19	16,5	13,0	36,0	19,0
1207735	R1A25M105M-0806	1/2"	3/4-16	3/8-19	16,5	15,5	38,0	22,0
1207736	R1A25M105M-0808	1/2"	3/4-16	1/2-14	16,5	17,0	41,0	27,0
1207737	R1A25M105M-0812	1/2"	3/4-16	3/4-14	16,5	20,0	45,5	32,0
1207738	R1A25M105M-1006	5/8"	7/8-14	3/8-19	19,5	15,5	41,5	24,0
1205996	R1A25M105M-1008	5/8"	7/8-14	1/2-14	19,5	17,0	45,5	27,0
1231525	R1A25M105M-1012	5/8"	7/8-14	3/4-14	19,5	20,0	48,5	32,0
1212837	R1A25M105M-1208	3/4"	1 1/16-12	1/2-14	22,0	17,0	50,0	32,0
1212838	R1A25M105M-1212	3/4"	1 1/16-12	3/4-14	22,0	20,0	50,0	32,0
1212839	R1A25M105M-1216	3/4"	1 1/16-12	1-11	22,0	18,0	53,0	41,0
1216372	R1A25M105M-1412	7/8"	1 3/16-12	3/4-14	22,5	20,0	51,5	32,0
1212840	R1A25M105M-1612	1"	1 5/16-12	3/4-14	23,0	20,0	55,0	36,0
1212841	R1A25M105M-1616	1"	1 5/16-12	1-11	23,0	22,0	54,0	41,0
1212842	R1A25M105M-1620	1"	1 5/16-12	1 1/4-11	23,0	23,0	56,0	50,0
1207739	R1A25M105M-2016	1 1/4"	1 5/8-12	1-11	24,5	22,0	58,5	46,0
1212843	R1A25M105M-2020	1 1/4"	1 5/8-12	1 1/4-11	24,5	23,0	59,5	50,0
1212844	R1A25M105M-2420	1 1/2"	1 7/8-12	1 1/4-11	27,5	23,0	62,5	50,0
1212845	R1A25M105M-2424	1 1/2"	1 7/8-12	1 1/2-11	27,5	25,0	64,5	55,0

// R1A25M106I

Straight connector

JIC Male - BSPP cylindric Male with elastomer

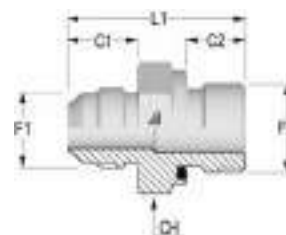

Item Code	Product Code	OD1	F1	F2	C1 (mm)	C2 (mm)	L1 (mm)	CH (mm)
1207410	R1A25M106I-0402	1/4"	7/16-20	1/8-28	14,0	8,0	30,0	14,0
1207411	R1A25M106I-0404	1/4"	7/16-20	1/4-19	14,0	12,0	36,0	19,0
1207412	R1A25M106I-0406	1/4"	7/16-20	3/8-19	14,0	12,0	35,5	22,0
1207413	R1A25M106I-0408	1/4"	7/16-20	1/2-14	14,0	14,0	39,0	27,0
1207993	R1A25M106I-0502	5/16"	1/2-20	1/8-28	14,0	8,0	30,5	14,0
1207414	R1A25M106I-0504	5/16"	1/2-20	1/4-19	14,0	12,0	35,0	19,0
1207415	R1A25M106I-0506	5/16"	1/2-20	3/8-19	14,0	12,0	35,5	22,0
1207416	R1A25M106I-0604	3/8"	9/16-18	1/4-19	14,0	12,0	35,0	19,0
1207417	R1A25M106I-0606	3/8"	9/16-18	3/8-19	14,0	12,0	36,0	22,0
1207418	R1A25M106I-0608	3/8"	9/16-18	1/2-14	14,0	14,0	39,5	27,0
1207419	R1A25M106I-0804	1/2"	3/4-16	1/4-19	16,5	12,0	38,5	19,0
1207420	R1A25M106I-0806	1/2"	3/4-16	3/8-19	16,5	12,0	38,5	22,0
1207421	R1A25M106I-0808	1/2"	3/4-16	1/2-14	16,5	14,0	42,0	27,0
1207422	R1A25M106I-0812	1/2"	3/4-16	3/4-14	16,5	16,0	45,5	32,0
1207423	R1A25M106I-1006	5/8"	7/8-14	3/8-19	19,5	12,0	42,5	24,0
1207424	R1A25M106I-1008	5/8"	7/8-14	1/2-14	19,5	14,0	44,5	27,0
1207425	R1A25M106I-1012	5/8"	7/8-14	3/4-14	19,5	16,0	49,5	32,0
1207426	R1A25M106I-1208	3/4"	1 1/16-12	1/2-14	22,0	14,0	49,0	32,0
1207427	R1A25M106I-1212	3/4"	1 1/16-12	3/4-14	22,0	16,0	51,0	32,0
1207428	R1A25M106I-1216	3/4"	1 1/16-12	1-11	22,0	18,0	53,5	41,0
1212875	R1A25M106I-1412	7/8"	1 3/16-12	3/4-14	22,5	16,0	53,5	32,0
1207429	R1A25M106I-1612	1"	1 5/16-12	3/4-14	23,0	16,0	51,5	36,0
1207430	R1A25M106I-1616	1"	1 5/16-12	1-11	23,0	18,0	54,5	41,0
1207431	R1A25M106I-1620	1"	1 5/16-12	1 1/4-11	23,0	20,0	58,5	50,0
1208006	R1A25M106I-2016	1" 1/4	1 5/8-12	1-11	24,5	18,0	62,0	46,0
1207432	R1A25M106I-2020	1" 1/4	1 5/8-12	1 1/4-11	24,5	20,0	60,0	50,0
1207433	R1A25M106I-2420	1" 1/2	1 7/8-12	1 1/4-11	27,5	20,0	64,0	50,0
1207434	R1A25M106I-2424	1" 1/2	1 7/8-12	1 1/2-11	27,5	22,0	67,0	55,0

Design and dimensions shown may be changed without prior notice

// R1A25M106H

Long connector

JIC Male - BSPP cylindric Male with elastomer

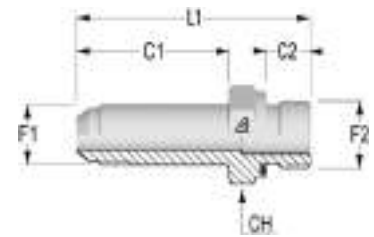

Item Code	Product Code	OD1	F1	F2	C1 (mm)	C2 (mm)	L1 (mm)	CH (mm)
1212846	R1A25M106H-0402	1/4"	7/16-20	1/8-28	35,0	8,0	50,0	14,0
1212847	R1A25M106H-0404	1/4"	7/16-20	1/4-19	35,0	12,0	55,5	19,0
1212848	R1A25M106H-0406	1/4"	7/16-20	3/8-19	35,0	12,0	56,8	22,0
1212849	R1A25M106H-0408	1/4"	7/16-20	1/2-14	35,0	14,0	60,3	27,0
1212850	R1A25M106H-0502	5/16"	1/2-20	1/8-28	37,0	8,0	53,3	14,0
1212851	R1A25M106H-0504	5/16"	1/2-20	1/4-19	37,0	12,0	57,5	19,0
1212852	R1A25M106H-0506	5/16"	1/2-20	3/8-19	37,0	12,0	57,5	22,0
1212853	R1A25M106H-0604	3/8"	9/16-18	1/4-19	39,0	12,0	59,5	19,0
1212854	R1A25M106H-0606	3/8"	9/16-18	3/8-19	39,5	12,0	62,0	22,0
1212855	R1A25M106H-0608	3/8"	9/16-18	1/2-14	39,0	14,0	63,0	27,0
1212856	R1A25M106H-0804	1/2"	3/4-16	1/4-19	47,8	12,0	69,8	22,0
1212857	R1A25M106H-0806	1/2"	3/4-16	3/8-19	47,8	12,0	70,8	22,0
1212858	R1A25M106H-0808	1/2"	3/4-16	1/2-14	48,0	14,0	73,5	27,0
1212859	R1A25M106H-0812	1/2"	3/4-16	3/4-14	48,0	16,0	76,8	32,0
1212860	R1A25M106H-1006	5/8"	7/8-14	3/8-19	53,0	12,0	74,0	24,0
1212861	R1A25M106H-1008	5/8"	7/8-14	1/2-14	53,1	14,0	78,1	27,0
1212862	R1A25M106H-1012	5/8"	7/8-14	3/4-14	53,1	16,0	84,1	32,0
1212863	R1A25M106H-1208	3/4"	1 1/16-12	1/2-14	63,5	14,0	90,5	30,0
1212864	R1A25M106H-1212	3/4"	1 1/16-12	3/4-14	64,0	16,0	92,5	32,0
1212865	R1A25M106H-1216	3/4"	1 1/16-12	1-11	63,5	18,0	95,0	41,0
1216388	R1A25M106H-1412	7/8"	1 3/16-12	3/4-14	68,3	16,0	99,3	32,0
1212866	R1A25M106H-1612	1"	1 5/16-12	3/4-14	72,0	16,0	100,0	36,0
1212867	R1A25M106H-1616	1"	1 5/16-12	1-11	72,1	18,0	103,6	41,0
1212868	R1A25M106H-1620	1"	1 5/16-12	1 1/4-11	72,1	20,0	107,6	50,0
1212869	R1A25M106H-2016	1" 1/4	1 5/8-12	1-11	88,0	18,0	123,0	46,0
1212870	R1A25M106H-2020	1" 1/4	1 5/8-12	1 1/4-11	88,1	20,0	123,6	50,0
1212871	R1A25M106H-2420	1" 1/2	1 7/8-12	1 1/4-11	98,6	20,0	135,1	50,0
1212872	R1A25M106H-2424	1" 1/2	1 7/8-12	1 1/2-11	98,6	22,0	138,1	55,0

// R1A25M406N

45° adjustable elbow connector

JIC Male - BSPP cylindric Male with O-Ring and retaining ring



Item Code	Product Code	OD1	F1	F2	C1 (mm)	C2 (mm)	CH (mm)	LN (mm)
1207325	R1A25M406N-0402	1/4"	7/16-20	1/8-28	19,5	26,5	12,0	14,0
1207326	R1A25M406N-0404	1/4"	7/16-20	1/4-19	21,0	29,0	14,0	19,0
1212959	R1A25M406N-0406	1/4"	7/16-20	3/8-19	22,0	33,0	17,0	22,0
1212960	R1A25M406N-0408	1/4"	7/16-20	1/2-14	22,5	38,5	22,0	27,0
1212961	R1A25M406N-0502	5/16"	1/2-20	1/8-28	19,5	26,5	14,0	14,0
1211702	R1A25M406N-0504	5/16"	1/2-20	1/4-19	19,5	26,5	14,0	19,0
1212962	R1A25M406N-0506	5/16"	1/2-20	3/8-19	21,0	32,5	17,0	22,0
1207327	R1A25M406N-0604	3/8"	9/16-18	1/4-19	21,0	29,0	14,0	19,0
1207328	R1A25M406N-0606	3/8"	9/16-18	3/8-19	22,0	33,0	17,0	22,0
1212963	R1A25M406N-0608	3/8"	9/16-18	1/2-14	22,5	38,5	22,0	27,0
1212964	R1A25M406N-0804	1/2"	3/4-16	1/4-19	25,5	30,0	19,0	19,0
1207329	R1A25M406N-0806	1/2"	3/4-16	3/8-19	25,5	33,0	19,0	22,0
1207330	R1A25M406N-0808	1/2"	3/4-16	1/2-14	25,5	38,5	22,0	27,0
1207331	R1A25M406N-1008	5/8"	7/8-14	1/2-14	28,0	38,5	22,0	27,0
1208292	R1A25M406N-1012	5/8"	7/8-14	3/4-14	30,0	44,0	27,0	36,0
1207333	R1A25M406N-1212	3/4"	1 1/16-12	3/4-14	32,5	44,0	27,0	36,0
1212967	R1A25M406N-1216	3/4"	1 1/16-12	1-11	37,0	47,0	33,0	41,0
1212968	R1A25M406N-1412	7/8"	1 3/16-12	3/4-14	35,0	45,5	33,0	36,0
1212969	R1A25M406N-1612	1"	1 5/16-12	3/4-14	37,0	47,0	33,0	36,0
1207334	R1A25M406N-1616	1"	1 5/16-12	1-11	37,0	47,0	33,0	41,0
1208380	R1A25M406N-2020	1"1/4	1 5/8-12	1 1/4-11	39,5	48,5	41,0	50,0
1211703	R1A25M406N-2424	1"1/2	1 7/8-12	1 1/2-11	45,0	48,0	48,0	55,0

Design and dimensions shown may be changed without prior notice

// R1A25M906N

90° adjustable elbow connector

JIC Male - BSPP cylindric Male with O-Ring and retaining ring

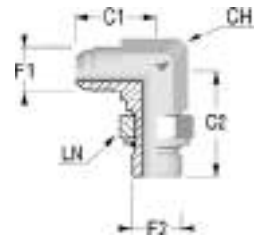

Item Code	Product Code	OD1	F1	F2	C1 (mm)	C2 (mm)	CH (mm)	LN (mm)
1207238	R1A25M906N-0402	1/4"	7/16-20	1/8-28	22,5	26,0	12,0	14,0
1207239	R1A25M906N-0404	1/4"	7/16-20	1/4-19	27,0	31,5	14,0	19,0
1213024	R1A25M906N-0406	1/4"	7/16-20	3/8-19	28,5	36,5	17,0	22,0
1213025	R1A25M906N-0408	1/4"	7/16-20	1/2-14	31,0	43,0	22,0	27,0
1207240	R1A25M906N-0502	5/16"	1/2-20	1/8-28	24,0	27,5	14,0	14,0
1207241	R1A25M906N-0504	5/16"	1/2-20	1/4-19	27,0	31,5	14,0	19,0
1207743	R1A25M906N-0506	5/16"	1/2-20	3/8-19	28,5	36,5	17,0	22,0
1207242	R1A25M906N-0604	3/8"	9/16-18	1/4-19	27,0	31,5	14,0	19,0
1207243	R1A25M906N-0606	3/8"	9/16-18	3/8-19	28,5	36,5	17,0	22,0
1208226	R1A25M906N-0608	3/8"	9/16-18	1/2-14	31,0	43,0	22,0	27,0
1207244	R1A25M906N-0804	1/2"	3/4-16	1/4-19	31,5	33,5	19,0	19,0
1207245	R1A25M906N-0806	1/2"	3/4-16	3/8-19	31,5	36,5	19,0	22,0
1207246	R1A25M906N-0808	1/2"	3/4-16	1/2-14	34,1	43,0	22,0	27,0
1213026	R1A25M906N-0812	1/2"	3/4-16	3/4-14	37,0	49,0	27,0	36,0
1207744	R1A25M906N-1006	5/8"	7/8-14	3/8-19	36,5	39,5	22,0	22,0
1207247	R1A25M906N-1008	5/8"	7/8-14	1/2-14	36,5	43,0	22,0	27,0
1207745	R1A25M906N-1012	5/8"	7/8-14	3/4-14	39,5	49,0	27,0	27,0
1207248	R1A25M906N-1208	3/4"	1 1/16-12	1/2-14	42,0	45,5	27,0	27,0
1207249	R1A25M906N-1212	3/4"	1 1/16-12	3/4-14	42,0	49,0	27,0	36,0
1207250	R1A25M906N-1216	3/4"	1 1/16-12	1-11	44,5	52,0	33,0	41,0
1213027	R1A25M906N-1412	7/8"	1 3/16-12	3/4-14	44,0	50,5	33,0	36,0
1207251	R1A25M906N-1612	1"	1 5/16-12	3/4-14	46,0	52,0	33,0	36,0
1207252	R1A25M906N-1616	1"	1 5/16-12	1-11	46,0	52,0	33,0	41,0
1207746	R1A25M906N-1620	1"	1 5/16-12	1 1/4-11	51,0	57,0	41,0	50,0
1207253	R1A25M906N-2016	1" 1/4	1 5/8-12	1-11	52,0	57,0	41,0	41,0
1207254	R1A25M906N-2020	1" 1/4	1 5/8-12	1 1/4-11	52,0	57,0	41,0	50,0
1213028	R1A25M906N-2420	1" 1/2	1 7/8-12	1 1/4-11	59,0	61,0	48,0	50,0
1207255	R1A25M906N-2424	1" 1/2	1 7/8-12	1 1/2-11	59,0	61,0	48,0	55,0

// R1A25M906Y

90° adjustable long elbow connector

JIC Male - BSPP cylindric Male with O-Ring and retaining ring

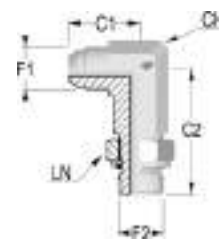

Item Code	Product Code	OD1	F1	F2	C1 (mm)	C2 (mm)	CH (mm)	LN (mm)
1213029	R1A25M906Y-0402	1/4"	7/16-20	1/8-28	24,0	46,0	14,0	14,0
1213030	R1A25M906Y-0404	1/4"	7/16-20	1/4-19	27,0	56,5	14,0	19,0
1213031	R1A25M906Y-0406	1/4"	7/16-20	3/8-19	28,5	67,0	17,0	22,0
1213032	R1A25M906Y-0408	1/4"	7/16-20	1/2-14	31,0	78,0	22,0	27,0
1213033	R1A25M906Y-0502	5/16"	1/2-20	1/8-28	24,0	49,5	14,0	14,0
1213034	R1A25M906Y-0504	5/16"	1/2-20	1/4-19	27,0	56,5	14,0	19,0
1213035	R1A25M906Y-0506	5/16"	1/2-20	3/8-19	28,5	61,0	17,0	22,0
1213036	R1A25M906Y-0604	3/8"	9/16-18	1/4-19	27,0	56,5	14,0	19,0
1213037	R1A25M906Y-0606	3/8"	9/16-18	3/8-19	28,5	67,0	17,0	22,0
1213038	R1A25M906Y-0608	3/8"	9/16-18	1/2-14	28,5	78,0	22,0	27,0
1213039	R1A25M906Y-0804	1/2"	3/4-16	1/4-19	31,5	64,0	22,0	19,0
1213040	R1A25M906Y-0806	1/2"	3/4-16	3/8-19	31,5	67,0	22,0	22,0
1213041	R1A25M906Y-0808	1/2"	3/4-16	1/2-14	34,1	78,0	22,0	27,0
1213042	R1A25M906Y-0812	1/2"	3/4-16	3/4-14	37,0	92,0	27,0	36,0
1213043	R1A25M906Y-1006	5/8"	7/8-14	3/8-19	36,5	75,0	22,0	22,0
1213044	R1A25M906Y-1008	5/8"	7/8-14	1/2-14	36,5	78,0	22,0	27,0
1213045	R1A25M906Y-1012	5/8"	7/8-14	3/4-14	39,5	92,0	27,0	36,0
1213046	R1A25M906Y-1208	3/4"	1 1/16-12	1/2-14	42,0	88,0	27,0	27,0
1213047	R1A25M906Y-1216	3/4"	1 1/16-12	1-11	44,5	105,0	33,0	41,0
1216418	R1A25M906Y-1412	7/8"	1 3/16-12	3/4-14	44,0	99,0	33,0	36,0
1213048	R1A25M906Y-1616	1"	1 5/16-12	1-11	46,0	105,0	33,0	41,0
1213049	R1A25M906Y-1620	1"	1 5/16-12	1 1/4-11	51,0	123,0	41,0	50,0
1213050	R1A25M906Y-2016	1"1/4	1 5/8-12	1-11	52,0	124,0	41,0	41,0
1213051	R1A25M906Y-2020	1"1/4	1 5/8-12	1 1/4-11	52,0	123,0	41,0	50,0
1213052	R1A25M906Y-2420	1"1/2	1 7/8-12	1 1/4-11	59,0	134,0	48,0	50,0
1213053	R1A25M906Y-2424	1"1/2	1 7/8-12	1 1/2-11	59,0	135,0	48,0	55,0

Design and dimensions shown may be changed without prior notice

// R1A25MT06N

Branch Tee adjustable elbow connector

JIC Male - BSPP cylindric Male with O-Ring and retaining ring

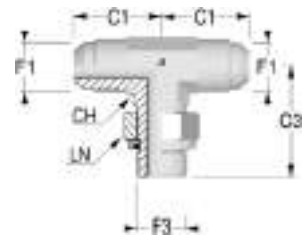

Item Code	Product Code	OD1	F1	F3	C1 (mm)	C3 (mm)	CH (mm)	LN (mm)
1208134	R1A25MT06N-0402	1/4"	7/16-20	1/8-28	24,5	26,0	12,0	14,0
1210701	R1A25MT06N-0404	1/4"	7/16-20	1/4-19	27,0	31,5	14,0	19,0
1212762	R1A25MT06N-0406	1/4"	7/16-20	3/8-19	28,5	36,5	17,0	22,0
1212763	R1A25MT06N-0408	1/4"	7/16-20	1/2-14	31,0	43,0	22,0	27,0
1212764	R1A25MT06N-0502	5/16"	1/2-20	1/8-28	24,0	27,5	14,0	14,0
1207314	R1A25MT06N-0504	5/16"	1/2-20	1/4-19	27,0	31,5	14,0	19,0
1212765	R1A25MT06N-0506	5/16"	1/2-20	3/8-19	28,5	36,5	17,0	22,0
1207313	R1A25MT06N-0604	3/8"	9/16-18	1/4-19	27,0	31,5	14,0	19,0
1210744	R1A25MT06N-0606	3/8"	9/16-18	3/8-19	28,5	36,5	17,0	22,0
1212766	R1A25MT06N-0608	3/8"	9/16-18	1/2-14	31,0	43,0	22,0	27,0
1212767	R1A25MT06N-0804	1/2"	3/4-16	1/4-19	31,5	33,5	19,0	19,0
1240190	R1A25MT06N-0806	1/2"	3/4-16	3/8-19	31,5	36,5	19,0	22,0
1207316	R1A25MT06N-0808	1/2"	3/4-16	1/2-14	34,0	43,0	22,0	27,0
1212768	R1A25MT06N-0812	1/2"	3/4-16	3/4-14	37,0	49,0	27,0	36,0
1212769	R1A25MT06N-1006	5/8"	7/8-14	3/8-19	36,5	39,5	22,0	22,0
1207317	R1A25MT06N-1008	5/8"	7/8-14	1/2-14	36,5	43,0	22,0	27,0
1212770	R1A25MT06N-1012	5/8"	7/8-14	3/4-14	36,5	43,0	27,0	36,0
1207318	R1A25MT06N-1208	3/4"	1 1/16-12	1/2-14	42,0	45,5	27,0	27,0
1207319	R1A25MT06N-1212	3/4"	1 1/16-12	3/4-14	42,0	49,0	27,0	27,0
1212771	R1A25MT06N-1216	3/4"	1 1/16-12	1-11	44,5	52,0	33,0	41,0
1216449	R1A25MT06N-1412	7/8"	1 3/16-12	3/4-14	44,0	50,5	33,0	27,0
1212772	R1A25MT06N-1612	1"	1 5/16-12	3/4-14	46,0	52,0	33,0	27,0
1207320	R1A25MT06N-1616	1"	1 5/16-12	1-11	46,0	52,0	33,0	41,0
1212773	R1A25MT06N-1620	1"	1 5/16-12	1 1/4-11	51,0	57,0	41,0	50,0
1212774	R1A25MT06N-2016	1" 1/4	1 5/8-12	1-11	52,0	57,0	41,0	41,0
1211631	R1A25MT06N-2020	1" 1/4	1 5/8-12	1 1/4-11	52,0	57,0	41,0	50,0
1211632	R1A25MT06N-2420	1" 1/2	1 7/8-12	1 1/4-11	59,0	61,0	48,0	50,0
1211633	R1A25MT06N-2424	1" 1/2	1 7/8-12	1 1/2-11	59,0	61,0	48,0	55,0

// R1A25ML06N

Run Tee adjustable elbow connector

JIC Male - BSPP cylindric Male with O-Ring and retaining ring

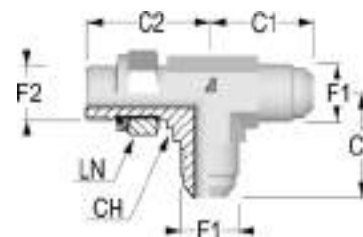

Item Code	Product Code	OD1	F1	F2	C1 (mm)	C2 (mm)	CH (mm)	LN (mm)
1210740	R1A25ML06N-0402	1/4"	7/16-20	1/8-28	22,5	26,5	12,0	14,0
1210742	R1A25ML06N-0404	1/4"	7/16-20	1/4-19	27,0	31,5	14,0	19,0
1212702	R1A25ML06N-0406	1/4"	7/16-20	3/8-19	28,5	36,5	17,0	22,0
1212703	R1A25ML06N-0408	1/4"	7/16-20	1/2-14	31,0	43,0	22,0	27,0
1210694	R1A25ML06N-0504	5/16"	1/2-20	1/4-19	27,0	31,5	14,0	19,0
1212704	R1A25ML06N-0506	5/16"	1/2-20	3/8-19	28,5	36,5	17,0	22,0
1207292	R1A25ML06N-0604	3/8"	9/16-18	1/4-19	27,0	31,5	14,0	19,0
1207293	R1A25ML06N-0606	3/8"	9/16-18	3/8-19	28,5	36,5	17,0	22,0
1212705	R1A25ML06N-0608	3/8"	9/16-18	1/2-14	31,0	43,0	22,0	27,0
1212706	R1A25ML06N-0804	1/2"	3/4-16	1/4-19	31,5	33,5	19,0	19,0
1207294	R1A25ML06N-0806	1/2"	3/4-16	3/8-19	31,5	36,5	19,0	22,0
1207295	R1A25ML06N-0808	1/2"	3/4-16	1/2-14	34,0	43,0	22,0	27,0
1212707	R1A25ML06N-0812	1/2"	3/4-16	3/4-14	37,0	49,0	27,0	36,0
1212708	R1A25ML06N-1006	5/8"	7/8-14	3/8-19	36,5	39,5	22,0	22,0
1207748	R1A25ML06N-1008	5/8"	7/8-14	1/2-14	36,5	43,0	22,0	27,0
1208030	R1A25ML06N-1012	5/8"	7/8-14	3/4-14	39,5	49,0	27,0	36,0
1207299	R1A25ML06N-1208	3/4"	1 1/16-12	1/2-14	42,0	45,5	27,0	27,0
1207296	R1A25ML06N-1212	3/4"	1 1/16-12	3/4-14	42,0	49,0	27,0	36,0
1208124	R1A25ML06N-1216	3/4"	1 1/16-12	1-11	44,5	52,0	33,0	41,0
1208277	R1A25ML06N-1612	1"	1 5/16-12	3/4-14	46,0	52,0	33,0	36,0
1207297	R1A25ML06N-1616	1"	1 5/16-12	1-11	46,0	52,0	33,0	41,0
1212710	R1A25ML06N-1620	1"	1 5/16-12	1 1/4-11	52,0	56,0	41,0	50,0
1212711	R1A25ML06N-2016	1 1/4"	1 5/8-12	1-11	52,0	57,0	41,0	41,0
1212712	R1A25ML06N-2420	1 1/2"	1 7/8-12	1 1/4-11	59,0	61,0	48,0	50,0
1208125	R1A25ML06N-2424	1 1/2"	1 7/8-12	1 1/2-11	59,0	61,0	48,0	55,0

Design and dimensions shown may be changed without prior notice

// R1A25M107M

Straight connector

JIC Male - BSPT Male

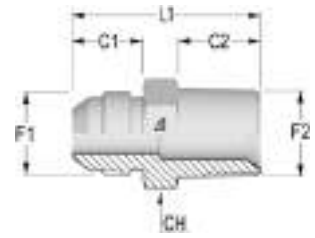

Item Code	Product Code	OD1	F1	F2	C1 (mm)	C2 (mm)	L1 (mm)	CH (mm)
1203683	R1A25M107M-0402	1/4"	7/16-20	1/8-28	14,0	10,0	30,5	14,0
1203682	R1A25M107M-0404	1/4"	7/16-20	1/4-19	14,0	14,5	35,5	14,0
1203626	R1A25M107M-0502	5/16"	1/2-20	1/8-28	14,0	10,0	30,5	14,0
1203625	R1A25M107M-0504	5/16"	1/2-20	1/4-19	14,0	14,5	35,5	14,0
1203711	R1A25M107M-0604	3/8"	9/16-18	1/4-19	14,0	14,5	35,5	17,0
1203712	R1A25M107M-0606	3/8"	9/16-18	3/8-19	14,0	14,5	35,5	19,0
1203710	R1A25M107M-0608	3/8"	9/16-18	1/2-14	14,0	19,0	41,0	22,0
1203667	R1A25M107M-0804	1/2"	3/4-16	1/4-19	16,5	14,5	38,5	19,0
1203669	R1A25M107M-0806	1/2"	3/4-16	3/8-19	16,5	14,5	38,5	19,0
1203666	R1A25M107M-0808	1/2"	3/4-16	1/2-14	16,5	19,0	43,5	22,0
1203696	R1A25M107M-1006	5/8"	7/8-14	3/8-19	19,5	14,5	42,0	24,0
1203694	R1A25M107M-1008	5/8"	7/8-14	1/2-14	19,5	19,0	46,5	24,0
1203695	R1A25M107M-1012	5/8"	7/8-14	3/4-14	19,5	19,0	48,5	27,0
1203614	R1A25M107M-1208	3/4"	1 1/16-12	1/2-14	22,0	19,0	51,0	27,0
1203615	R1A25M107M-1212	3/4"	1 1/16-12	3/4-14	22,0	19,0	51,0	27,0
1203613	R1A25M107M-1216	3/4"	1 1/16-12	1-11	22,0	24,0	56,5	36,0
1216391	R1A25M107M-1412	7/8"	1 3/16-12	3/4-14	22,5	19,0	50,5	32,0
1203638	R1A25M107M-1612	1"	1 5/16-12	3/4-14	23,0	19,0	53,0	36,0
1203636	R1A25M107M-1616	1"	1 5/16-12	1-11	23,0	24,0	58,0	36,0
1203644	R1A25M107M-2016	1"1/4	1 5/8-12	1-11	24,5	24,0	60,5	46,0
1203645	R1A25M107M-2020	1"1/4	1 5/8-12	1 1/4-11	24,5	25,0	61,0	46,0
1203652	R1A25M107M-2424	1"1/2	1 7/8-12	1 1/2-11	27,5	25,5	68,0	50,0

// R1A25M907M
90° elbow connector
JIC Male - BSPT Male

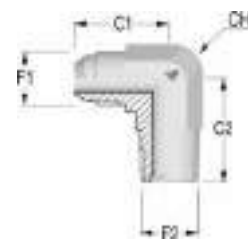

Item Code	Product Code	OD1	F1	F2	C1 (mm)	C2 (mm)	CH (mm)
1203874	R1A25M907M-0402	1/4"	7/16-20	1/8-28	22,5	19,5	12,0
1203873	R1A25M907M-0404	1/4"	7/16-20	1/4-19	27,0	27,5	14,0
1203840	R1A25M907M-0502	5/16"	1/2-20	1/8-28	24,0	20,0	14,0
1203839	R1A25M907M-0504	5/16"	1/2-20	1/4-19	27,0	27,0	14,0
1203895	R1A25M907M-0604	3/8"	9/16-18	1/4-19	27,0	27,0	14,0
1203896	R1A25M907M-0606	3/8"	9/16-18	3/8-19	28,5	31,0	17,0
1203894	R1A25M907M-0608	3/8"	9/16-18	1/2-14	31,0	37,5	22,0
1203864	R1A25M907M-0804	1/2"	3/4-16	1/4-19	31,5	31,0	19,0
1203865	R1A25M907M-0806	1/2"	3/4-16	3/8-19	31,5	31,0	19,0
1203863	R1A25M907M-0808	1/2"	3/4-16	1/2-14	34,0	37,0	22,0
1203883	R1A25M907M-1006	5/8"	7/8-14	3/8-19	36,5	32,5	22,0
1203881	R1A25M907M-1008	5/8"	7/8-14	1/2-14	36,5	40,0	22,0
1203882	R1A25M907M-1012	5/8"	7/8-14	3/4-14	39,5	40,5	27,0
1203835	R1A25M907M-1212	3/4"	1 1/16-12	3/4-14	42,0	40,5	27,0
1203833	R1A25M907M-1216	3/4"	1 1/16-12	1-11	44,5	50,0	33,0
1216419	R1A25M907M-1412	7/8"	1 3/16-12	3/4-14	44,0	43,0	33,0
1203847	R1A25M907M-1612	1"	1 5/16-12	3/4-14	46,0	45,0	33,0
1203846	R1A25M907M-1616	1"	1 5/16-12	1-11	46,0	50,0	33,0
1205460	R1A25M907M-2016	1"1/4	1 5/8-12	1-11	52,0	59,5	41,0
1203853	R1A25M907M-2020	1"1/4	1 5/8-12	1 1/4-11	52,0	60,5	41,0
1213054	R1A25M907M-2424	1"1/2	1 7/8-12	1 1/2-11	59,0	67,0	48,0

Design and dimensions shown may be changed without prior notice

// METRIC

// R1A2511525

Straight connector

JIC Female - Metric Male with O-Ring

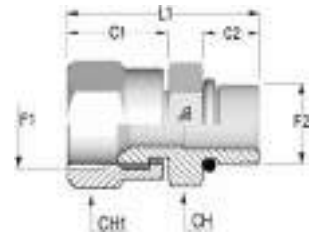

Item Code	Product Code	OD1	F1	F2	C1 (mm)	C2 (mm)	L1 (mm)	CH (mm)	CH1 (mm)
1207442	R1A2511525-0410	1/4"	7/16-20	M10X1.0	17,0	11,0	34,5	14,0	16,0
1216347	R1A2511525-0412	1/4"	7/16-20	M12X1.5	17,0	13,5	36,5	17,0	16,0
1216348	R1A2511525-0510	5/16"	1/2-20	M10X1.0	18,5	11,0	36,5	14,0	17,0
1207443	R1A2511525-0512	5/16"	1/2-20	M12X1.5	18,5	13,5	39,0	17,0	17,0
1216349	R1A2511525-0514	5/16"	1/2-20	M14X1.5	18,5	13,5	40,0	19,0	17,0
1207444	R1A2511525-0614	3/8"	9/16-18	M14X1.5	18,5	13,5	41,0	19,0	19,0
1216350	R1A2511525-0616	3/8"	9/16-18	M16X1.5	18,5	14,0	42,5	22,0	19,0
1216351	R1A2511525-0818	1/2"	3/4-16	M18X1.5	22,2	15,0	45,5	24,0	25,0
1207629	R1A2511525-1018	5/8"	7/8-14	M18X1.5	25,2	15,0	48,2	24,0	27,0
1216352	R1A2511525-1020	5/8"	7/8-14	M20X1.5	25,2	16,5	49,7	24,0	27,0
1207446	R1A2511525-1022	5/8"	7/8-14	M22X1.5	25,2	15,5	50,7	27,0	27,0
1216353	R1A2511525-1222	3/4"	1 1/16-12	M22X1.5	27,3	15,5	53,5	27,0	32,0
1207447	R1A2511525-1227	3/4"	1 1/16-12	M27X2	27,3	18,5	57,5	32,0	32,0
1216354	R1A2511525-1426	7/8"	1 3/16-12	M26X1.5	27,0	21,0	60,0	32,0	36,0
1216355	R1A2511525-1627	1"	1 5/16-12	M27X2	29,6	18,5	60,0	36,0	38,0
1207448	R1A2511525-1633	1"	1 5/16-12	M33X2.0	29,6	19,0	61,0	41,0	38,0

// R1A25M1525

Straight connector

JIC Male - Metric Male with O-Ring

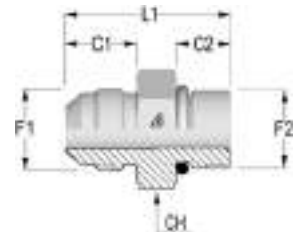

Item Code	Product Code	OD1	F1	F2	C1 (mm)	C2 (mm)	L1 (mm)	CH (mm)
1207635	R1A25M1525-0412	1/4"	7/16-20	M12X1.5	14,0	13,5	31,5	17,0
1207636	R1A25M1525-0510	5/16"	1/2-20	M10X1.0	14,0	11,0	30,5	14,0
1224083	R1A25M1525-0512	5/16"	1/2-20	M12X1.5	14,0	13,5	33,5	17,0
1207408	R1A25M1525-0614	3/8"	9/16-18	M14X1.5	14,0	13,5	33,5	19,0
1207639	R1A25M1525-0616	3/8"	9/16-18	M16X1.5	14,0	14,0	35,0	22,0
1211696	R1A25M1525-0816	1/2"	3/4-16	M16X1.5	16,5	14,0	38,0	22,0
1207387	R1A25M1525-0818	1/2"	3/4-16	M18X1.5	16,5	15,0	38,5	24,0
1225818	R1A25M1525-1018	5/8"	7/8-14	M18X1.5	19,5	15,0	42,0	24,0
1212958	R1A25M1525-1020	5/8"	7/8-14	M20X1.5	19,5	16,5	41,5	24,0
1207405	R1A25M1525-1022	5/8"	7/8-14	M22X1.5	19,5	15,5	43,0	27,0
1207404	R1A25M1525-1222	3/4"	1 1/16-12	M22X1.5	22,0	15,5	45,5	27,0
1207403	R1A25M1525-1227	3/4"	1 1/16-12	M27X2	22,0	18,5	49,0	32,0
1216402	R1A25M1525-1627	1"	1 5/16-12	M27X2	23,0	18,5	50,5	36,0
1207402	R1A25M1525-1633	1"	1 5/16-12	M33X2.0	23,0	19,0	51,0	41,0
1207401	R1A25M1525-2042	1 1/4"	1 5/8-12	M42X2	24,5	19,0	55,0	50,0
1207400	R1A25M1525-2448	1 1/2"	1 7/8-12	M48X2.0	27,5	17,5	60,0	55,0

// R1A25M152I

Straight connector

JIC Male - Metric Male with elastomer

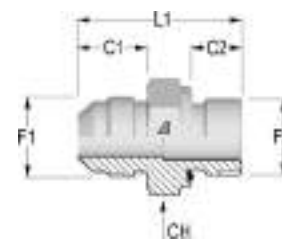

Item Code	Product Code	OD1	F1	F2	C1 (mm)	C2 (mm)	L1 (mm)	CH (mm)
1207390	R1A25M152I-0410	1/4"	7/16-20	M10X1.0	14,0	8,0	31,0	14,0
1212950	R1A25M152I-0412	1/4"	7/16-20	M12X1.5	14,0	12,0	33,5	17,0
1212951	R1A25M152I-0510	5/16"	1/2-20	M10X1.0	14,0	8,0	30,5	14,0
1207391	R1A25M152I-0512	5/16"	1/2-20	M12X1.5	14,0	12,0	33,5	17,0
1208306	R1A25M152I-0514	5/16"	1/2-20	M14X1.5	14,0	12,0	35,0	19,0
1207392	R1A25M152I-0614	3/8"	9/16-18	M14X1.5	14,0	12,0	33,5	19,0
1212952	R1A25M152I-0616	3/8"	9/16-18	M16X1.5	14,0	12,0	35,5	22,0
1207393	R1A25M152I-0816	1/2"	3/4-16	M16X1.5	16,5	12,0	37,5	22,0
1207388	R1A25M152I-0818	1/2"	3/4-16	M18X1.5	16,5	12,0	39,0	24,0
1207389	R1A25M152I-1018	5/8"	7/8-14	M18X1.5	19,5	12,0	41,5	24,0
1212953	R1A25M152I-1020	5/8"	7/8-14	M20X1.5	19,5	14,0	43,5	24,0
1207394	R1A25M152I-1022	5/8"	7/8-14	M22X1.5	19,5	14,0	43,0	27,0
1207395	R1A25M152I-1222	3/4"	1 1/16-12	M22X1.5	22,0	14,0	45,5	27,0
1207396	R1A25M152I-1227	3/4"	1 1/16-12	M27X2	22,0	16,0	49,0	32,0
1216405	R1A25M152I-1426	7/8"	1 3/16-12	M26X1.5	22,5	16,0	49,5	32,0
1212957	R1A25M152I-1627	1"	1 5/16-12	M27X2	23,0	16,0	55,0	36,0
1207397	R1A25M152I-1633	1"	1 5/16-12	M33X2.0	23,0	18,0	51,5	41,0
1207398	R1A25M152I-2042	1"1/4	1 5/8-12	M42X2	24,5	20,0	55,0	50,0
1207399	R1A25M152I-2448	1"1/2	1 7/8-12	M48X2.0	27,5	22,0	60,5	55,0

// R1A25M152H

Long connector

JIC Male - Metric Male with elastomer

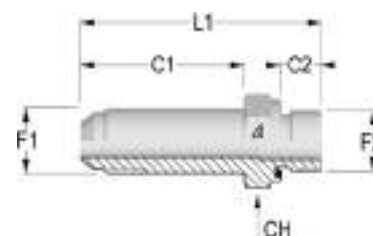

Item Code	Product Code	OD1	F1	F2	C1 (mm)	C2 (mm)	L1 (mm)	CH (mm)
1212934	R1A25M152H-0410	1/4"	7/16-20	M10X1.0	35,0	9,5	51,0	14,0
1212935	R1A25M152H-0510	5/16"	1/2-20	M10X1.0	37,0	9,5	53,0	14,0
1212936	R1A25M152H-0512	5/16"	1/2-20	M12X1.5	37,0	14,0	55,5	17,0
1212937	R1A25M152H-0514	5/16"	1/2-20	M14X1.5	37,0	14,0	56,5	19,0
1212938	R1A25M152H-0614	3/8"	9/16-18	M14X1.5	39,0	14,0	58,5	19,0
1212939	R1A25M152H-0616	3/8"	9/16-18	M16X1.5	39,0	14,0	60,0	22,0
1212940	R1A25M152H-0816	1/2"	3/4-16	M16X1.5	48,0	14,0	69,0	22,0
1212941	R1A25M152H-0818	1/2"	3/4-16	M18X1.5	48,0	14,5	70,5	24,0
1212942	R1A25M152H-1018	5/8"	7/8-14	M18X1.5	53,0	14,5	75,5	24,0
1212943	R1A25M152H-1022	5/8"	7/8-14	M22X1.5	53,0	17,0	78,0	27,0
1212944	R1A25M152H-1222	3/4"	1 1/16-12	M22X1.5	63,0	17,0	89,0	27,0
1212945	R1A25M152H-1227	3/4"	1 1/16-12	M27X2	63,0	19,0	92,5	32,0
1212946	R1A25M152H-1627	1"	1 5/16-12	M27X2	72,0	19,0	102,0	36,0
1212947	R1A25M152H-1633	1"	1 5/16-12	M33X2.0	72,0	21,0	102,5	41,0
1212948	R1A25M152H-2042	1"1/4	1 5/8-12	M42X2	88,0	23,0	121,0	50,0
1212949	R1A25M152H-2448	1"1/2	1 7/8-12	M48X2.0	88,0	25,0	136,0	55,0

Design and dimensions shown may be changed without prior notice

// R1A25M952Q

90° adjustable elbow connector

JIC Male - Metric Male with O-Ring and retaining ring

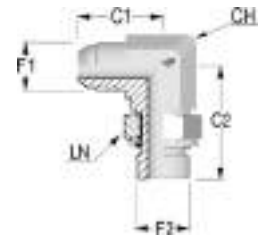

Item Code	Product Code	OD1	F1	F2	C1 (mm)	C2 (mm)	CH (mm)	LN (mm)
1207275	R1A25M952Q-0410	1/4"	7/16-20	M10X1.0	22,5	27,5	12,0	14,0
1213138	R1A25M952Q-0412	1/4"	7/16-20	M12X1.5	27,0	31,5	14,0	17,0
1213140	R1A25M952Q-0510	5/16"	1/2-20	M10X1.0	24,0	27,5	14,0	14,0
1207276	R1A25M952Q-0512	5/16"	1/2-20	M12X1.5	27,0	31,5	14,0	17,0
1213141	R1A25M952Q-0514	5/16"	1/2-20	M14X1.5	27,0	32,5	14,0	19,0
1207277	R1A25M952Q-0614	3/8"	9/16-18	M14X1.5	27,0	32,5	14,0	19,0
1213142	R1A25M952Q-0616	3/8"	9/16-18	M16X1.5	28,5	36,5	17,0	22,0
1207278	R1A25M952Q-0816	1/2"	3/4-16	M16X1.5	31,5	36,5	19,0	22,0
1207523	R1A25M952Q-0818	1/2"	3/4-16	M18X1.5	31,5	39,5	19,0	24,0
1207279	R1A25M952Q-1018	5/8"	7/8-14	M18X1.5	36,5	41,5	22,0	24,0
1213144	R1A25M952Q-1020	5/8"	7/8-14	M20X1.5	36,5	43,0	22,0	27,0
1207280	R1A25M952Q-1022	5/8"	7/8-14	M22X1.5	36,5	43,0	22,0	27,0
1207281	R1A25M952Q-1222	3/4"	1 1/16-12	M22X1.5	42,0	45,5	27,0	27,0
1210693	R1A25M952Q-1227	3/4"	1 1/16-12	M27X2	42,0	51,5	27,0	32,0
1213145	R1A25M952Q-1426	7/8"	1 3/16-12	M26X1.5	44,0	50,5	27,0	36,0
1213146	R1A25M952Q-1627	1"	1 5/16-12	M27X2	46,0	55,0	33,0	32,0
1207282	R1A25M952Q-1633	1"	1 5/16-12	M33X1.5	46,0	55,0	33,0	41,0
1211742	R1A25M952Q-2042	1"1/4	1 5/8-12	M42X2	52,0	60,0	41,0	50,0
1213147	R1A25M952Q-2448	1"1/2	1 7/8-12	M48X1.5	59,0	67,0	48,0	55,0

// R1A25M952Y

90° adjustable long elbow connector

JIC Male - Metric Male with O-Ring and retaining ring

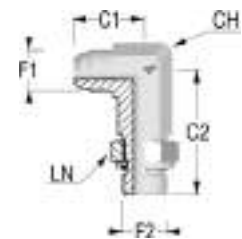

Item Code	Product Code	OD1	F1	F2	C1 (mm)	C2 (mm)	CH (mm)	LN (mm)
1213148	R1A25M952Y-0410	1/4"	7/16-20	M10X1.0	22,5	46,0	12,0	14,0
1213149	R1A25M952Y-0412	1/4"	7/16-20	M12X1.5	27,0	53,5	14,0	17,0
1213150	R1A25M952Y-0510	5/16"	1/2-20	M10X1.0	24,0	49,5	14,0	14,0
1213151	R1A25M952Y-0512	5/16"	1/2-20	M12X1.5	27,0	53,5	14,0	17,0
1213152	R1A25M952Y-0514	5/16"	1/2-20	M14X1.5	27,0	56,5	14,0	19,0
1213153	R1A25M952Y-0614	3/8"	9/16-18	M14X1.5	27,0	56,5	14,0	19,0
1213154	R1A25M952Y-0616	3/8"	9/16-18	M16X1.5	28,5	67,0	17,0	22,0
1213155	R1A25M952Y-0816	1/2"	3/4-16	M16X1.5	31,5	67,0	19,0	22,0
1213156	R1A25M952Y-0818	1/2"	3/4-16	M18X1.5	31,5	67,0	19,0	24,0
1213157	R1A25M952Y-1018	5/8"	7/8-14	M18X1.5	36,5	75,0	22,0	24,0
1213158	R1A25M952Y-1020	5/8"	7/8-14	M20X1.5	36,5	78,0	22,0	27,0
1213159	R1A25M952Y-1022	5/8"	7/8-14	M22X1.5	36,5	78,0	22,0	27,0
1213160	R1A25M952Y-1222	3/4"	1 1/16-12	M22X1.5	42,0	88,0	27,0	27,0
1213161	R1A25M952Y-1227	3/4"	1 1/16-12	M27X2	42,0	95,0	27,0	32,0
1216432	R1A25M952Y-1426	7/8"	1 3/16-12	M26X1.5	44,0	97,0	27,0	36,0
1213162	R1A25M952Y-1627	1"	1 5/16-12	M27X2	46,0	105,0	33,0	32,0
1213163	R1A25M952Y-1633	1"	1 5/16-12	M33X1.5	46,0	105,0	33,0	41,0
1213164	R1A25M952Y-2042	1"1/4	1 5/8-12	M42X2	52,0	124,0	41,0	50,0
1213165	R1A25M952Y-2448	1"1/2	1 7/8-12	M48X1.5	59,0	141,0	48,0	55,0

// R1A25MT52Q

Branch Tee adjustable elbow connector

JIC Male - Metric Male with O-Ring and retaining ring



Item Code	Product Code	OD1	F1	F3	C1 (mm)	C3 (mm)	CH (mm)	LN (mm)
1211640	R1A25MT52Q-0410	1/4"	7/16-20	M10X1.0	22,5	27,5	12,0	14,0
1212815	R1A25MT52Q-0412	1/4"	7/16-20	M12X1.5	27,0	31,5	14,0	17,0
1212816	R1A25MT52Q-0510	5/16"	1/2-20	M10X1.0	24,0	27,5	14,0	14,0
1210706	R1A25MT52Q-0512	5/16"	1/2-20	M12X1.5	27,0	31,5	14,0	17,0
1212817	R1A25MT52Q-0514	5/16"	1/2-20	M14X1.5	27,0	32,5	14,0	19,0
1207324	R1A25MT52Q-0614	3/8"	9/16-18	M14X1.5	27,0	32,5	14,0	19,0
1212818	R1A25MT52Q-0616	3/8"	9/16-18	M16X1.5	28,5	36,5	17,0	22,0
1210707	R1A25MT52Q-0816	1/2"	3/4-16	M16X1.5	31,5	36,5	19,0	22,0
1212819	R1A25MT52Q-0818	1/2"	3/4-16	M18X1.5	31,5	39,5	19,0	24,0
1212820	R1A25MT52Q-1020	5/8"	7/8-14	M20X1.5	36,5	43,0	22,0	27,0
1211641	R1A25MT52Q-1022	5/8"	7/8-14	M22X1.5	36,5	43,0	22,0	27,0
1212821	R1A25MT52Q-1222	3/4"	1 1/16-12	M22X1.5	42,0	45,5	27,0	27,0
1211642	R1A25MT52Q-1227	3/4"	1 1/16-12	M27X1.5	42,0	51,5	27,0	32,0
1216493	R1A25MT52Q-1426	7/8"	1 3/16-12	M26X1.5	44,0	50,5	27,0	36,0
1212822	R1A25MT52Q-1627	1"	1 5/16-12	M27X2	46,0	55,0	33,0	32,0
1211643	R1A25MT52Q-1633	1"	1 5/16-12	M33X1.5	46,0	55,0	33,0	41,0
1211644	R1A25MT52Q-2042	1 1/4"	1 5/8-12	M42X2	52,0	60,0	41,0	50,0
1211645	R1A25MT52Q-2448	1 1/2"	1 7/8-12	M48X1.5	59,0	67,0	48,0	55,0

// R1A25ML52Q

Run Tee adjustable elbow connector

JIC Male - Metric Male with O-Ring and retaining ring

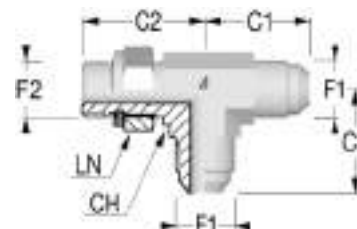

Item Code	Product Code	OD1	F1	F2	C1 (mm)	C2 (mm)	CH (mm)	LN (mm)
1210699	R1A25ML52Q-0410	1/4"	7/16-20	M10X1.0	22,5	27,5	12,0	14,0
1212753	R1A25ML52Q-0412	1/4"	7/16-20	M12X1.5	27,0	31,5	14,0	17,0
1212754	R1A25ML52Q-0510	5/16"	1/2-20	M10X1.0	24,0	27,5	14,0	14,0
1211626	R1A25ML52Q-0512	5/16"	1/2-20	M12X1.5	27,0	31,5	14,0	17,0
1212755	R1A25ML52Q-0514	5/16"	1/2-20	M14X1.5	27,0	32,5	14,0	19,0
1207303	R1A25ML52Q-0614	3/8"	9/16-18	M14X1.5	27,0	32,5	14,0	19,0
1212756	R1A25ML52Q-0616	3/8"	9/16-18	M16X1.5	28,5	36,5	17,0	22,0
1207302	R1A25ML52Q-0816	1/2"	3/4-16	M16X1.5	31,5	36,5	19,0	22,0
1212757	R1A25ML52Q-0818	1/2"	3/4-16	M18X1.5	31,5	39,5	19,0	24,0
1212758	R1A25ML52Q-1018	5/8"	7/8-14	M18X1.5	36,5	41,5	22,0	24,0
1212759	R1A25ML52Q-1020	5/8"	7/8-14	M20X1.5	36,5	43,0	22,0	27,0
1210700	R1A25ML52Q-1022	5/8"	7/8-14	M22X1.5	36,5	43,0	22,0	27,0
1212760	R1A25ML52Q-1222	3/4"	1 1/16-12	M22X1.5	42,0	45,5	27,0	27,0
1211627	R1A25ML52Q-1227	3/4"	1 1/16-12	M27X2	42,0	51,5	27,0	32,0
1216448	R1A25ML52Q-1426	7/8"	1 3/16-12	M26X1.5	44,0	50,5	27,0	36,0
1212761	R1A25ML52Q-1627	1"	1 5/16-12	M27X2	46,0	55,0	33,0	32,0
1211628	R1A25ML52Q-1633	1"	1 5/16-12	M33X1.5	46,0	55,0	33,0	41,0
1211629	R1A25ML52Q-2042	1 1/4"	1 5/8-12	M42X2	52,0	60,0	41,0	50,0
1211630	R1A25ML52Q-2448	1 1/2"	1 7/8-12	M48X1.5	59,0	67,0	48,0	55,0

Design and dimensions shown may be changed without prior notice

// SAE UNF

// R1A25M1305

Straight connector

JIC Male - SAE UNF/UN Male with O-Ring

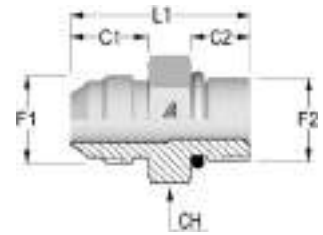

Item Code	Product Code	OD1	F1	F2	C1 (mm)	C2 (mm)	L1 (mm)	CH (mm)
1207370	R1A25M1305-0404	1/4"	7/16-20	7/16-20	14,0	9,0	31,0	14,0
1207371	R1A25M1305-0405	1/4"	7/16-20	1/2-20	14,0	9,0	31,0	16,0
1207630	R1A25M1305-0406	1/4"	7/16-20	9/16-18	14,0	10,0	32,5	17,0
1207372	R1A25M1305-0505	5/16"	1/2-20	1/2-20	14,0	9,0	31,0	17,0
1208278	R1A25M1305-0604	3/8"	9/16-18	7/16-20	14,0	9,0	32,0	17,0
1216397	R1A25M1305-0605	3/8"	9/16-18	1/2-20	14,0	9,0	32,5	17,0
1207373	R1A25M1305-0606	3/8"	9/16-18	9/16-18	14,0	10,0	33,0	17,0
1207374	R1A25M1305-0608	3/8"	9/16-18	3/4-16	14,0	11,0	35,0	22,0
1207375	R1A25M1305-0808	1/2"	3/4-16	3/4-16	16,5	11,0	38,0	22,0
1207376	R1A25M1305-0810	1/2"	3/4-16	7/8-14	16,5	12,5	40,5	27,0
1207631	R1A25M1305-0812	1/2"	3/4-16	1 1/16-12	16,5	15,0	44,5	32,0
1207632	R1A25M1305-1008	5/8"	7/8-14	3/4-16	19,5	14,3	41,5	27,0
1207377	R1A25M1305-1010	5/8"	7/8-14	7/8-14	19,5	12,5	43,0	27,0
1207633	R1A25M1305-1012	5/8"	7/8-14	1 1/16-12	19,5	15,0	47,0	32,0
1207378	R1A25M1305-1208	3/4"	1 1/16-12	3/4-16	22,0	14,3	48,5	27,0
1207379	R1A25M1305-1210	3/4"	1 1/16-12	7/8-14	22,0	12,5	47,5	27,0
1207380	R1A25M1305-1212	3/4"	1 1/16-12	1 1/16-12	22,0	15,0	50,0	32,0
1207381	R1A25M1305-1216	3/4"	1 1/16-12	1 5/16-12	22,0	15,0	50,5	38,0
1216398	R1A25M1305-1414	7/8"	1 3/16-12	1 3/16-12	22,5	15,0	50,5	36,0
1207382	R1A25M1305-1612	1"	1 5/16-12	1 1/16-12	23,0	18,3	50,5	36,0
1207383	R1A25M1305-1616	1"	1 5/16-12	1 5/16-12	23,0	15,0	52,0	38,0
1207634	R1A25M1305-1620	1"	1 5/16-12	1 5/8-12	23,0	15,0	54,0	46,0
1205938	R1A25M1305-2016	1"1/4	1 5/8-12	1 5/16-12	24,5	19,1	55,5	46,0
1207384	R1A25M1305-2020	1"1/4	1 5/8-12	1 5/8-12	24,5	15,0	55,0	46,0
1207385	R1A25M1305-2424	1"1/2	1 7/8-12	1 7/8-12	27,5	15,0	60,5	55,0

// R1A25M130J

Long connector

JIC Male - SAE UNF/UN Male with O-Ring

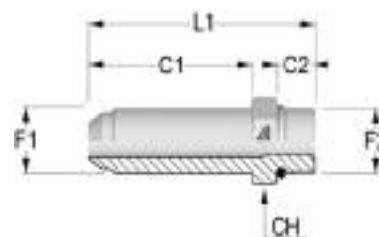

Item Code	Product Code	OD1	F1	F2	C1 (mm)	C2 (mm)	L1 (mm)	CH (mm)
1212883	R1A25M130J-0404	1/4"	7/16-20	7/16-20	35,0	9,0	52,5	17,0
1212884	R1A25M130J-0405	1/4"	7/16-20	1/2-20	35,0	9,0	52,5	17,0
1212885	R1A25M130J-0406	1/4"	7/16-20	9/16-18	35,0	10,0	54,5	19,0
1212886	R1A25M130J-0505	5/16"	1/2-20	1/2-20	37,0	9,0	54,5	16,0
1212888	R1A25M130J-0606	3/8"	9/16-18	9/16-18	39,0	10,0	58,5	19,0
1212889	R1A25M130J-0608	3/8"	9/16-18	3/4-16	39,0	11,0	60,0	24,0
1212890	R1A25M130J-0808	1/2"	3/4-16	3/4-16	48,0	11,0	68,5	24,0
1212891	R1A25M130J-0810	1/2"	3/4-16	7/8-14	48,0	12,5	71,5	27,0
1212892	R1A25M130J-0812	1/2"	3/4-16	1 1/16-12	48,0	15,0	71,5	32,0
1212893	R1A25M130J-1008	5/8"	7/8-14	3/4-16	53,0	11,0	75,5	27,0
1212894	R1A25M130J-1010	5/8"	7/8-14	7/8-14	53,0	12,5	77,0	27,0
1212895	R1A25M130J-1012	5/8"	7/8-14	1 1/16-12	53,0	15,0	81,5	32,0
1212898	R1A25M130J-1212	3/4"	1 1/16-12	1 1/16-12	63,0	15,0	91,5	32,0
1212899	R1A25M130J-1216	3/4"	1 1/16-12	1 5/16-12	63,0	15,0	92,5	41,0
1216400	R1A25M130J-1414	7/8"	1 3/16-12	1 3/16-12	68,0	15,0	96,5	36,0
1212900	R1A25M130J-1612	1"	1 5/16-12	1 1/16-12	72,0	15,0	100,0	41,0
1212901	R1A25M130J-1616	1"	1 5/16-12	1 5/16-12	72,0	15,0	101,0	41,0
1212903	R1A25M130J-2020	1 1/4"	1 5/8-12	1 5/8-12	88,0	15,0	119,0	50,0
1212904	R1A25M130J-2424	1 1/2"	1 7/8-12	1 7/8-12	98,0	15,0	131,0	55,0

// R1A2511305

Straight connector

JIC Female - SAE UNF/UN Male with O-Ring

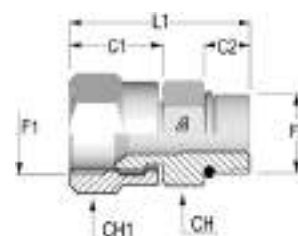

Item Code	Product Code	OD1	F1	F2	C1 (mm)	C2 (mm)	L1 (mm)	CH (mm)	CH1 (mm)
1207435	R1A2511305-0404	1/4"	7/16-20	7/16-20	17,0	9,0	34,0	14,0	16,0
1213175	R1A2511305-0405	1/4"	7/16-20	1/2-20	17,0	9,0	34,0	16,0	16,0
1213176	R1A2511305-0406	1/4"	7/16-20	9/16-18	17,0	10,0	35,0	17,0	16,0
1207436	R1A2511305-0505	5/16"	1/2-20	1/2-20	18,5	9,0	35,5	17,0	17,0
1207437	R1A2511305-0606	3/8"	9/16-18	9/16-18	18,5	10,0	36,5	17,0	19,0
1213177	R1A2511305-0608	3/8"	9/16-18	3/4-16	18,5	11,0	39,5	22,0	19,0
1207438	R1A2511305-0808	1/2"	3/4-16	3/4-16	22,2	11,0	43,2	22,0	25,0
1213178	R1A2511305-0810	1/2"	3/4-16	7/8-14	22,2	12,5	46,2	27,0	27,0
1213179	R1A2511305-0812	1/2"	3/4-16	1 1/16-12	22,2	15,0	49,2	32,0	25,0
1213180	R1A2511305-1008	5/8"	7/8-14	3/4-16	25,2	11,0	46,2	22,0	27,0
1207439	R1A2511305-1010	5/8"	7/8-14	7/8-14	25,2	12,5	49,2	27,0	27,0
1213181	R1A2511305-1012	5/8"	7/8-14	1 1/16-12	25,2	15,0	52,2	32,0	27,0
1213183	R1A2511305-1210	3/4"	1 1/16-12	7/8-14	27,3	12,5	51,3	27,0	32,0
1207440	R1A2511305-1212	3/4"	1 1/16-12	1 1/16-12	27,3	15,0	54,3	32,0	32,0
1213184	R1A2511305-1216	3/4"	1 1/16-12	1 5/16-12	27,3	15,0	54,3	38,0	32,0
1216346	R1A2511305-1414	7/8"	1 3/16-12	1 3/16-12	27,0	15,0	54,0	36,0	36,0
1213185	R1A2511305-1612	1"	1 5/16-12	1 1/16-12	29,6	15,0	56,6	32,0	38,0
1207441	R1A2511305-1616	1"	1 5/16-12	1 5/16-12	29,6	15,0	56,6	41,0	38,0
1213208	R1A2521305-2424	1 1/2"	1 7/8-12	1 7/8-12	18,4	15,0	67,0	50,0	55,0

Design and dimensions shown may be changed without prior notice

// R1A25M4305

45° adjustable elbow connector

JIC Male - SAE UNF/UN Male with O-Ring

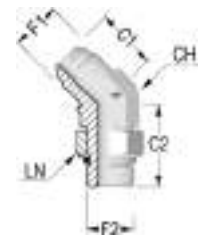

Item Code	Product Code	OD1	F1	F2	C1 (mm)	C2 (mm)	CH (mm)	LN (mm)
1212979	R1A25M4305-0405	1/4"	7/16-20	1/2-20	21,0	26,5	14,0	19,0
1207335	R1A25M4305-0505	5/16"	1/2-20	1/2-20	21,0	26,5	14,0	19,0
1207336	R1A25M4305-0606	3/8"	9/16-18	9/16-18	19,5	26,5	14,0	22,0
1212980	R1A25M4305-0608	3/8"	9/16-18	3/4-16	22,5	38,0	19,0	24,0
1207337	R1A25M4305-0808	1/2"	3/4-16	3/4-16	25,0	33,0	19,0	24,0
1212981	R1A25M4305-0810	1/2"	3/4-16	7/8-14	27,5	42,5	22,0	30,0
1212982	R1A25M4305-1008	5/8"	7/8-14	3/4-16	28,0	37,0	22,0	24,0
1207338	R1A25M4305-1010	5/8"	7/8-14	7/8-14	28,0	38,5	22,0	30,0
1216413	R1A25M4305-1012	5/8"	7/8-14	1 1/16-12	28,5	44,0	27,0	36,0
1212983	R1A25M4305-1208	3/4"	1 1/16-12	3/4-16	32,5	37,5	27,0	24,0
1211710	R1A25M4305-1210	3/4"	1 1/16-12	7/8-14	32,5	40,5	27,0	27,0
1207339	R1A25M4305-1212	3/4"	1 1/16-12	1 1/16-12	32,5	44,0	27,0	36,0
1212984	R1A25M4305-1216	3/4"	1 1/16-12	1 5/16-12	32,5	47,0	33,0	41,0
1212985	R1A25M4305-1414	7/8"	1 3/16-12	1 3/16-12	37,0	47,0	33,0	38,0
1212986	R1A25M4305-1612	1"	1 5/16-12	1 1/16-12	37,5	44,0	33,0	36,0
1207340	R1A25M4305-1616	1"	1 5/16-12	1 5/16-12	37,5	47,0	33,0	41,0
1212987	R1A25M4305-1620	1"	1 5/16-12	1 5/8-12	40,0	48,5	41,0	50,0
1211711	R1A25M4305-2020	1" 1/4	1 5/8-12	1 5/8-12	40,5	48,5	41,0	50,0
1211712	R1A25M4305-2424	1" 1/2	1 7/8-12	1 7/8-12	45,0	48,5	48,0	55,0

// R1A25M9305

90° adjustable elbow connector

JIC Male - SAE UNF/UN Male with O-Ring

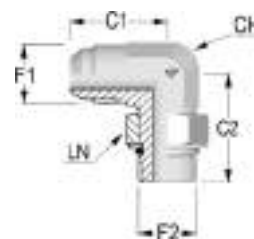

Item Code	Product Code	OD1	F1	F2	C1 (mm)	C2 (mm)	CH (mm)	LN (mm)
1207256	R1A25M9305-0404	1/4"	7/16-20	7/16-20	22,5	26,0	12,0	17,0
1207640	R1A25M9305-0405	1/4"	7/16-20	1/2-20	24,0	27,5	14,0	17,0
1213077	R1A25M9305-0406	1/4"	7/16-20	9/16-18	27,0	31,5	14,0	19,0
1207257	R1A25M9305-0505	5/16"	1/2-20	1/2-20	24,0	27,5	14,0	17,0
1207258	R1A25M9305-0606	3/8"	9/16-18	9/16-18	27,0	31,5	14,0	19,0
1207641	R1A25M9305-0608	3/8"	9/16-18	3/4-16	28,5	36,5	19,0	24,0
1216429	R1A25M9305-0610	3/8"	9/16-18	7/8-14	31,0	43,5	22,0	27,0
1207259	R1A25M9305-0808	1/2"	3/4-16	3/4-16	31,5	36,5	19,0	24,0
1207642	R1A25M9305-0810	1/2"	3/4-16	7/8-14	34,0	43,0	22,0	27,0
1213079	R1A25M9305-0812	1/2"	3/4-16	1 1/16-12	37,0	49,0	27,0	32,0
1207643	R1A25M9305-1008	5/8"	7/8-14	3/4-16	36,5	39,5	22,0	24,0
1207260	R1A25M9305-1010	5/8"	7/8-14	7/8-14	36,5	43,0	22,0	27,0
1213080	R1A25M9305-1012	5/8"	7/8-14	1 1/16-12	39,5	49,0	27,0	32,0
1213081	R1A25M9305-1208	3/4"	1 1/16-12	3/4-16	42,0	42,0	27,0	22,0
1207261	R1A25M9305-1210	3/4"	1 1/16-12	7/8-14	42,0	45,5	27,0	27,0
1207262	R1A25M9305-1212	3/4"	1 1/16-12	1 1/16-12	42,0	49,0	27,0	32,0
1213082	R1A25M9305-1216	3/4"	1 1/16-12	1 5/16-12	44,5	52,0	33,0	41,0
1213083	R1A25M9305-1414	7/8"	1 3/16-12	1 3/16-12	44,0	50,5	33,0	41,0
1207263	R1A25M9305-1612	1"	1 5/16-12	1 1/16-12	46,0	52,0	33,0	32,0
1207264	R1A25M9305-1616	1"	1 5/16-12	1 5/16-12	46,0	54,0	33,0	41,0
1213084	R1A25M9305-1620	1"	1 5/16-12	1 5/8-12	51,0	57,0	41,0	50,0
1207265	R1A25M9305-2020	1"1/4	1 5/8-12	1 5/8-12	52,0	57,0	41,0	50,0
1211738	R1A25M9305-2424	1"1/2	1 7/8-12	1 7/8-12	59,0	61,0	48,0	55,0

Design and dimensions shown may be changed without prior notice

// R1A25M930J

90° adjustable long elbow connector

JIC Male - SAE UNF/UN Male with O-Ring

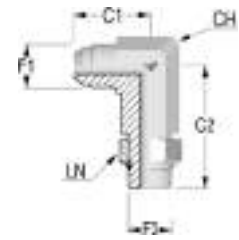

Item Code	Product Code	OD1	F1	F2	C1 (mm)	C2 (mm)	CH (mm)	LN (mm)
1213056	R1A25M930J-0404	1/4"	7/16-20	7/16-20	23,5	46,0	14,0	17,0
1213057	R1A25M930J-0405	1/4"	7/16-20	1/2-20	24,0	49,5	14,0	17,0
1213058	R1A25M930J-0406	1/4"	7/16-20	9/16-18	27,0	56,5	17,0	19,0
1213059	R1A25M930J-0505	5/16"	1/2-20	1/2-20	24,0	49,5	14,0	17,0
1213060	R1A25M930J-0606	3/8"	9/16-18	9/16-18	27,0	56,5	17,0	19,0
1213061	R1A25M930J-0608	3/8"	9/16-18	3/4-16	28,5	67,0	22,0	24,0
1213062	R1A25M930J-0808	1/2"	3/4-16	3/4-16	31,5	67,0	22,0	24,0
1213063	R1A25M930J-0810	1/2"	3/4-16	7/8-14	34,0	78,0	22,0	27,0
1213064	R1A25M930J-0812	1/2"	3/4-16	1 1/16-12	37,0	92,0	27,0	32,0
1213065	R1A25M930J-1008	5/8"	7/8-14	3/4-16	36,5	75,0	22,0	24,0
1213066	R1A25M930J-1010	5/8"	7/8-14	7/8-14	36,5	78,0	22,0	27,0
1213067	R1A25M930J-1012	5/8"	7/8-14	1 1/16-12	39,5	92,0	27,0	32,0
1213068	R1A25M930J-1208	3/4"	1 1/16-12	3/4-16	42,0	85,0	27,0	24,0
1213069	R1A25M930J-1210	3/4"	1 1/16-12	7/8-14	44,6	88,0	27,0	27,0
1213070	R1A25M930J-1212	3/4"	1 1/16-12	1 1/16-12	42,0	92,0	27,0	32,0
1213071	R1A25M930J-1216	3/4"	1 1/16-12	1 5/16-12	44,5	105,0	33,0	41,0
1216431	R1A25M930J-1414	7/8"	1 3/16-12	1 3/16-12	44,0	92,0	33,0	41,0
1213072	R1A25M930J-1612	1"	1 5/16-12	1 1/16-12	46,0	105,0	33,0	32,0
1213073	R1A25M930J-1616	1"	1 5/16-12	1 5/16-12	46,0	105,0	33,0	41,0
1213074	R1A25M930J-1620	1"	1 5/16-12	1 5/8-12	51,0	124,0	41,0	50,0
1213075	R1A25M930J-2020	1" 1/4	1 5/8-12	1 5/8-12	52,0	124,0	41,0	50,0
1213076	R1A25M930J-2424	1" 1/2	1 7/8-12	1 7/8-12	59,0	135,0	48,0	55,0

// R1A25MT305

Branch Tee adjustable elbow connector
JIC Male - SAE UNF/UN Male with O-Ring

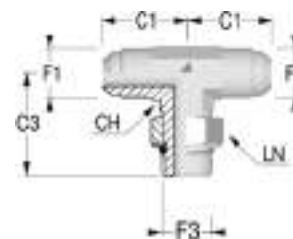

Item Code	Product Code	OD1	F1	F3	C1 (mm)	C3 (mm)	CH (mm)	LN (mm)
1210702	R1A25MT305-0404	1/4"	7/16-20	7/16-20	22,5	26,0	12,0	16,0
1212777	R1A25MT305-0405	1/4"	7/16-20	1/2-20	24,0	27,5	14,0	17,0
1212778	R1A25MT305-0406	1/4"	7/16-20	9/16-18	27,0	31,5	14,0	19,0
1210703	R1A25MT305-0505	5/16"	1/2-20	1/2-20	24,0	27,5	14,0	17,0
1207321	R1A25MT305-0606	3/8"	9/16-18	9/16-18	27,0	31,5	14,0	19,0
1212779	R1A25MT305-0608	3/8"	9/16-18	3/4-16	28,5	36,5	19,0	24,0
1207322	R1A25MT305-0808	1/2"	3/4-16	3/4-16	31,5	36,5	19,0	24,0
1212780	R1A25MT305-0810	1/2"	3/4-16	7/8-14	34,0	43,0	22,0	27,0
1212781	R1A25MT305-0812	1/2"	3/4-16	1 1/16-12	37,0	49,0	27,0	32,0
1212782	R1A25MT305-1008	5/8"	7/8-14	3/4-16	36,5	39,5	22,0	24,0
1207323	R1A25MT305-1010	5/8"	7/8-14	7/8-14	36,5	43,0	22,0	27,0
1212783	R1A25MT305-1012	5/8"	7/8-14	1 1/16-12	36,5	49,0	22,0	32,0
1212784	R1A25MT305-1208	3/4"	1 1/16-12	3/4-16	42,0	42,0	27,0	24,0
1212785	R1A25MT305-1210	3/4"	1 1/16-12	7/8-14	42,0	45,5	27,0	27,0
1210704	R1A25MT305-1212	3/4"	1 1/16-12	1 1/16-12	42,0	49,0	27,0	32,0
1212786	R1A25MT305-1216	3/4"	1 1/16-12	1 5/16-12	44,5	52,0	33,0	41,0
1216491	R1A25MT305-1414	7/8"	1 3/16-12	1 3/16-12	44,0	50,5	33,0	38,0
1212787	R1A25MT305-1612	1"	1 5/16-12	1 1/16-12	46,0	52,0	33,0	32,0
1210705	R1A25MT305-1616	1"	1 5/16-12	1 5/16-12	46,0	54,6	33,0	41,0
1212788	R1A25MT305-1620	1"	1 5/16-12	1 5/8-12	51,0	57,0	41,0	50,0
1212789	R1A25MT305-2020	1" 1/4	1 5/8-12	1 5/8-12	52,0	57,0	41,0	50,0
1212790	R1A25MT305-2424	1" 1/2	1 7/8-12	1 7/8-12	59,0	61,0	48,0	55,0

Design and dimensions shown may be changed without prior notice

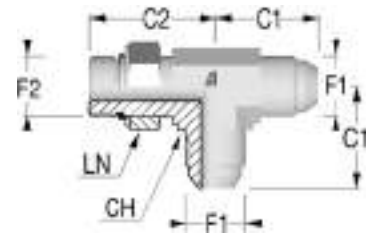
// R1A25ML305**Run Tee adjustable elbow connector****JIC Male - SAE UNF/UN Male with O-Ring**

Item Code	Product Code	OD1	F1	F2	C1 (mm)	C2 (mm)	CH (mm)	LN (mm)
1210695	R1A25ML305-0404	1/4"	7/16-20	7/16-20	22,5	26,0	12,0	17,0
1212716	R1A25ML305-0405	1/4"	7/16-20	1/2-20	24,0	27,5	14,0	17,0
1212717	R1A25ML305-0406	1/4"	7/16-20	9/16-18	27,0	31,5	14,0	22,0
1210696	R1A25ML305-0505	5/16"	1/2-20	1/2-20	24,0	27,5	14,0	19,0
1207300	R1A25ML305-0606	3/8"	9/16-18	9/16-18	27,0	31,5	14,0	22,0
1212718	R1A25ML305-0608	3/8"	9/16-18	3/4-16	28,5	36,5	19,0	24,0
1210697	R1A25ML305-0808	1/2"	3/4-16	3/4-16	31,5	36,5	19,0	24,0
1212719	R1A25ML305-0810	1/2"	3/4-16	7/8-14	34,0	43,0	22,0	30,0
1212720	R1A25ML305-0812	1/2"	3/4-16	1 1/16-12	37,0	49,0	27,0	32,0
1212721	R1A25ML305-1008	5/8"	7/8-14	3/4-16	36,5	39,5	22,0	24,0
1210698	R1A25ML305-1010	5/8"	7/8-14	7/8-14	36,5	39,5	22,0	24,0
1212722	R1A25ML305-1012	5/8"	7/8-14	1 1/16-12	39,5	49,0	27,0	32,0
1212723	R1A25ML305-1208	3/4"	1 1/16-12	3/4-16	42,0	42,0	27,0	24,0
1212724	R1A25ML305-1210	3/4"	1 1/16-12	7/8-14	42,0	45,5	27,0	27,0
1207301	R1A25ML305-1212	3/4"	1 1/16-12	1 1/16-12	42,0	49,0	27,0	32,0
1212725	R1A25ML305-1216	3/4"	1 1/16-12	1 5/16-12	44,5	52,0	33,0	41,0
1211624	R1A25ML305-1616	1"	1 5/16-12	1 5/16-12	46,0	54,6	33,0	41,0
1212727	R1A25ML305-1620	1"	1 5/16-12	1 5/8-12	51,0	57,0	41,0	50,0
1211625	R1A25ML305-2020	1"1/4	1 5/8-12	1 5/8-12	52,0	57,0	41,0	50,0
1212728	R1A25ML305-2424	1"1/2	1 7/8-12	1 7/8-12	59,0	61,0	48,0	55,0

// NPTF

// R1A25M128M

Straight connector
JIC - NPTF Male

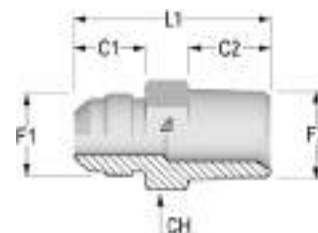

Item Code	Product Code	OD1	F1	F2	C1 (mm)	C2 (mm)	L1 (mm)	CH (mm)
1203679	R1A25M128M-0402	1/4"	7/16-20	1/8-27	14,0	10,0	31,0	14,0
1203678	R1A25M128M-0404	1/4"	7/16-20	1/4-18	14,0	14,5	36,0	14,0
1203621	R1A25M128M-0502	5/16"	1/2-20	1/8-27	14,0	10,0	31,0	14,0
1203620	R1A25M128M-0504	5/16"	1/2-20	1/4-18	14,0	14,5	36,0	14,0
1203704	R1A25M128M-0602	3/8"	9/16-18	1/8-27	14,0	10,0	32,0	17,0
1203703	R1A25M128M-0604	3/8"	9/16-18	1/4-18	14,0	14,5	36,5	17,0
1203705	R1A25M128M-0606	3/8"	9/16-18	3/8-18	14,0	14,5	36,5	19,0
1203702	R1A25M128M-0608	3/8"	9/16-18	1/2-14	14,0	18,0	43,0	22,0
1203659	R1A25M128M-0804	1/2"	3/4-16	1/4-18	16,5	14,5	39,0	19,0
1203661	R1A25M128M-0806	1/2"	3/4-16	3/8-18	16,5	14,5	39,0	19,0
1203658	R1A25M128M-0808	1/2"	3/4-16	1/2-14	16,5	18,0	44,5	22,0
1203660	R1A25M128M-0812	1/2"	3/4-16	3/4-14	16,5	19,0	47,0	27,0
1212881	R1A25M128M-1004	5/8"	7/8-14	1/4-18	19,5	14,5	43,0	24,0
1203691	R1A25M128M-1006	5/8"	7/8-14	3/8-18	19,5	14,5	43,5	24,0
1203689	R1A25M128M-1008	5/8"	7/8-14	1/2-14	19,5	18,0	47,0	24,0
1203690	R1A25M128M-1012	5/8"	7/8-14	3/4-14	19,5	19,0	49,5	27,0
1203608	R1A25M128M-1208	3/4"	1 1/16-12	1/2-14	22,0	18,0	51,5	27,0
1203609	R1A25M128M-1212	3/4"	1 1/16-12	3/4-14	22,0	19,0	52,5	27,0
1203607	R1A25M128M-1216	3/4"	1 1/16-12	1-11 1/2	22,0	24,0	57,0	36,0
1216396	R1A25M128M-1412	7/8"	1 3/16-12	3/4-14	22,5	19,0	53,0	30,0
1203633	R1A25M128M-1612	1"	1 5/16-12	3/4-14	23,0	19,0	53,5	36,0
1203631	R1A25M128M-1616	1"	1 5/16-12	1-11 1/2	23,0	24,0	58,5	36,0
1203642	R1A25M128M-2016	1"1/4	1 5/8-12	1-11 1/2	24,5	24,0	61,5	46,0
1203643	R1A25M128M-2020	1"1/4	1 5/8-12	1 1/4-11 1/2	24,5	25,0	62,5	46,0
1212882	R1A25M128M-2420	1"1/2	1 7/8-12	1 1/4-11 1/2	27,5	25,0	67,5	50,0
1203649	R1A25M128M-2424	1"1/2	1 7/8-12	1 1/2-11 1/2	27,5	25,5	68,0	50,0

Design and dimensions shown may be changed without prior notice

// R1A251128M

Straight connector

JIC Female - NPTF Male

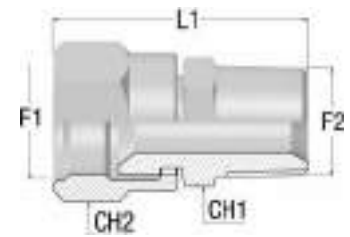

Item Code	Product Code	OD1	F1	F2	L1 (mm)	CH1 (mm)	CH2 (mm)
1210848	R1A251128M-0402	1/4"	7/16-20	1/8-27	34,2	16,0	14,0
1207618	R1A251128M-0404	1/4"	7/16-20	1/4-18	39,2	16,0	14,0
1213170	R1A251128M-0502	5/16"	1/2-20	1/8-27	35,0	17,0	14,0
1207619	R1A251128M-0504	5/16"	1/2-20	1/4-18	41,0	17,0	14,0
1213171	R1A251128M-0602	3/8"	9/16-18	1/8-27	36,5	19,0	14,0
1207620	R1A251128M-0604	3/8"	9/16-18	1/4-18	41,0	19,0	14,0
1207621	R1A251128M-0606	3/8"	9/16-18	3/8-18	41,5	19,0	19,0
1213173	R1A251128M-0804	1/2"	3/4-16	1/4-18	44,0	25,0	19,0
1207622	R1A251128M-0806	1/2"	3/4-16	3/8-18	43,2	25,0	19,0
1207624	R1A251128M-1008	5/8"	7/8-14	1/2-14	49,7	27,0	22,0
1213174	R1A251128M-1012	5/8"	7/8-14	3/4-14	52,5	27,0	27,0
1207625	R1A251128M-1208	3/4"	1 1/16-12	1/2-14	54,3	32,0	27,0
1207626	R1A251128M-1212	3/4"	1 1/16-12	3/4-14	55,3	32,0	27,0
1216345	R1A251128M-1412	7/8"	1 3/16-12	3/4-14	55,2	36,0	30,0
1207627	R1A251128M-1612	1"	1 5/16-12	3/4-14	58,6	38,0	32,0
1207628	R1A251128M-1616	1"	1 5/16-12	1-11 1/2	64,0	38,0	36,0
1213206	R1A252128M-2020	1 1/4"	1 5/8-12	1 1/4-11 1/2	69,4	50,0	46,0

// R1A25M428M

45° elbow connector

JIC - NPTF Male



Item Code	Product Code	OD1	F1	F2	C1 (mm)	C2 (mm)	CH (mm)
1203920	R1A25M428M-0402	1/4"	7/16-20	1/8-27	19,0	16,0	12,0
1203919	R1A25M428M-0404	1/4"	7/16-20	1/4-18	21,0	21,5	14,0
1210674	R1A25M428M-0504	5/16"	1/2-20	1/4-18	21,0	21,5	14,0
1203925	R1A25M428M-0604	3/8"	9/16-18	1/4-18	21,0	21,5	14,0
1203927	R1A25M428M-0606	3/8"	9/16-18	3/8-18	22,0	24,0	19,0
1203916	R1A25M428M-0806	1/2"	3/4-16	3/8-18	25,0	24,0	19,0
1203915	R1A25M428M-0808	1/2"	3/4-16	1/2-14	25,5	29,5	22,0
1212975	R1A25M428M-1006	5/8"	7/8-14	3/8-18	28,0	24,5	22,0
1203923	R1A25M428M-1008	5/8"	7/8-14	1/2-14	28,0	29,0	22,0
1212976	R1A25M428M-1012	5/8"	7/8-14	3/4-14	30,0	30,5	27,0
1203907	R1A25M428M-1208	3/4"	1 1/16-12	1/2-14	32,5	30,5	27,0
1203908	R1A25M428M-1212	3/4"	1 1/16-12	3/4-14	32,5	30,5	27,0
1203913	R1A25M428M-1616	1"	1 5/16-12	1-11 1/2	37,0	37,5	33,0

// R1A25M928M

90° elbow connector

JIC - NPTF Male



Item Code	Product Code	OD1	F1	F2	C1 (mm)	C2 (mm)	CH (mm)
1203872	R1A25M928M-0402	1/4"	7/16-20	1/8-27	22,5	19,5	12,0
1203871	R1A25M928M-0404	1/4"	7/16-20	1/4-18	27,0	27,5	14,0
1203838	R1A25M928M-0502	5/16"	1/2-20	1/8-27	24,0	19,5	14,0
1203837	R1A25M928M-0504	5/16"	1/2-20	1/4-18	26,5	27,5	14,0
1203889	R1A25M928M-0604	3/8"	9/16-18	1/4-18	27,0	27,5	14,0
1203891	R1A25M928M-0606	3/8"	9/16-18	3/8-18	28,5	31,0	19,0
1203888	R1A25M928M-0608	3/8"	9/16-18	1/2-14	31,0	37,0	22,0
1203861	R1A25M928M-0806	1/2"	3/4-16	3/8-18	31,5	31,0	19,0
1203858	R1A25M928M-0808	1/2"	3/4-16	1/2-14	34,0	37,5	22,0
1203860	R1A25M928M-0812	1/2"	3/4-16	3/4-14	37,0	40,5	27,0
1203878	R1A25M928M-1008	5/8"	7/8-14	1/2-14	36,5	37,0	22,0
1203879	R1A25M928M-1012	5/8"	7/8-14	3/4-14	39,5	40,5	27,0
1203831	R1A25M928M-1208	3/4"	1 1/16-12	1/2-14	42,0	40,5	27,0
1203832	R1A25M928M-1212	3/4"	1 1/16-12	3/4-14	42,0	40,5	27,0
1203843	R1A25M928M-1616	1"	1 5/16-12	1-11 1/2	46,0	50,0	33,0
1203851	R1A25M928M-2016	1" 1/4	1 5/8-12	1-11 1/2	52,0	59,0	41,0
1203852	R1A25M928M-2020	1" 1/4	1 5/8-12	1 1/4-11 1/2	52,0	60,0	41,0

Design and dimensions shown may be changed without prior notice

// FLANGES

// R1A25M133W

Straight flange SAE J518 code 61

JIC - Low pressure

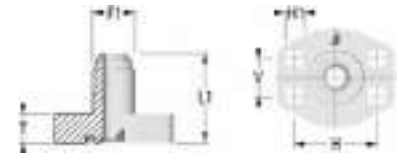

Item Code	Product Code	OD1	F1	F2	T (mm)	H1 (mm)	H (mm)	V (mm)	L1 (mm)
1212906	R1A25M133W-0808	1/2"	3/4-16	1/2	14,0	9,0	38,1	17,5	41,0
1212907	R1A25M133W-1008	5/8"	7/8-14	1/2	14,0	9,0	38,1	17,5	44,0
1212908	R1A25M133W-1012	5/8"	7/8-14	3/4	15,0	11,0	47,6	22,2	47,0
1212909	R1A25M133W-1208	3/4"	1 1/16-12	1/2	14,0	9,0	38,1	17,5	46,0
1212910	R1A25M133W-1212	3/4"	1 1/16-12	3/4	15,0	11,0	47,6	22,2	49,0
1212911	R1A25M133W-1216	3/4"	1 1/16-12	1	17,0	11,0	52,4	26,2	51,0
1212912	R1A25M133W-1612	1"	1 5/16-12	3/4	15,0	11,0	47,6	22,2	50,0
1212913	R1A25M133W-1616	1"	1 5/16-12	1	17,0	11,0	52,4	26,2	52,0
1212914	R1A25M133W-1620	1"	1 5/16-12	1 1/4	21,0	11,5	58,7	30,2	56,0
1212915	R1A25M133W-2016	1"1/4	1 5/8-12	1	17,0	11,0	52,4	26,2	54,0
1212916	R1A25M133W-2020	1"1/4	1 5/8-12	1 1/4	21,0	11,5	58,4	30,2	58,0
1212917	R1A25M133W-2024	1"1/4	1 5/8-12	1 1/2	24,0	13,5	69,9	35,7	64,0
1212918	R1A25M133W-2420	1"1/2	1 7/8-12	1 1/4	21,0	11,5	58,4	30,2	61,0
1212919	R1A25M133W-2424	1"1/2	1 7/8-12	1 1/2	24,0	13,5	69,9	35,7	67,0

// R1A25M136W

Straight flange SAE J518 code 62

JIC - High pressure

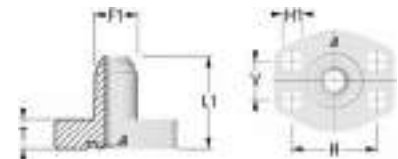

Item Code	Product Code	OD1	F1	F2	T (mm)	H1 (mm)	H (mm)	V (mm)	L1 (mm)
1212920	R1A25M136W-0808	1/2"	3/4-16	1/2	15,0	9,0	40,5	18,2	42,0
1212921	R1A25M136W-1008	5/8"	7/8-14	1/2	15,0	9,0	40,5	18,2	45,0
1212922	R1A25M136W-1012	5/8"	7/8-14	3/4	17,0	11,0	50,8	23,8	49,0
1212923	R1A25M136W-1208	3/4"	1 1/16-12	1/2	15,0	9,0	40,5	18,2	47,0
1212924	R1A25M136W-1212	3/4"	1 1/16-12	3/4	17,0	11,0	50,8	23,8	51,0
1212925	R1A25M136W-1216	3/4"	1 1/16-12	1	21,0	13,0	57,2	27,8	58,0
1212926	R1A25M136W-1612	1"	1 5/16-12	3/4	17,0	11,0	50,8	23,8	52,0
1212927	R1A25M136W-1616	1"	1 5/16-12	1	21,0	13,0	57,2	27,8	59,0
1212928	R1A25M136W-1620	1"	1 5/16-12	1 1/4	24,0	15,0	66,7	31,8	64,0
1212929	R1A25M136W-2016	1"1/4	1 5/8-12	1	21,0	13,0	57,2	27,8	61,0
1212930	R1A25M136W-2020	1"1/4	1 5/8-12	1 1/4	24,0	15,0	66,7	31,8	66,0
1212931	R1A25M136W-2024	1"1/4	1 5/8-12	1 1/2	27,0	17,0	79,4	36,5	70,0
1212932	R1A25M136W-2420	1"1/2	1 7/8-12	1 1/4	24,0	15,0	66,7	31,8	69,0
1212933	R1A25M136W-2424	1"1/2	1 7/8-12	1 1/2	27,0	17,0	79,4	36,5	73,0

// R1A25M933W

90° flange SAE J518 code 61

JIC - Low pressure



Item Code	Product Code	OD1	F1	F2	C1 (mm)	T (mm)	H1 (mm)	H (mm)	V (mm)
1213085	R1A25M933W-0808	1/2"	3/4-16	1/2	40,0	17,0	9,0	38,1	17,5
1213086	R1A25M933W-1008	5/8"	7/8-14	1/2	42,0	17,0	9,0	38,1	17,5
1213087	R1A25M933W-1012	5/8"	7/8-14	3/4	45,0	20,0	11,0	47,6	22,2
1213088	R1A25M933W-1208	3/4"	1 1/16-12	1/2	42,0	20,0	9,0	38,1	17,5
1213089	R1A25M933W-1212	3/4"	1 1/16-12	3/4	47,0	20,0	11,0	47,6	22,2
1213090	R1A25M933W-1216	3/4"	1 1/16-12	1	50,0	20,0	11,0	52,4	26,2
1213091	R1A25M933W-1612	1"	1 5/16-12	3/4	48,0	25,0	11,0	47,6	22,2
1213092	R1A25M933W-1616	1"	1 5/16-12	1	51,0	25,0	11,0	52,4	26,2
1213093	R1A25M933W-1620	1"	1 5/16-12	1 1/4	56,0	25,0	11,5	58,7	30,2
1213094	R1A25M933W-2016	1"1/4	1 5/8-12	1	53,0	31,0	11,0	52,4	26,2
1213095	R1A25M933W-2020	1"1/4	1 5/8-12	1 1/4	58,0	31,0	11,5	58,4	30,2
1213096	R1A25M933W-2024	1"1/4	1 5/8-12	1 1/2	63,0	31,0	13,5	69,9	35,7
1213097	R1A25M933W-2420	1"1/2	1 7/8-12	1 1/4	58,0	37,0	11,5	58,4	30,2
1213098	R1A25M933W-2424	1"1/2	1 7/8-12	1 1/2	66,0	37,0	13,5	69,9	35,7

// R1A25M936W

90° flange SAE J518 code 62

JIC - High pressure



Item Code	Product Code	OD1	F1	F2	C1 (mm)	T (mm)	H1 (mm)	H (mm)	V (mm)
1213111	R1A25M936W-0808	1/2"	3/4-16	1/2	40,0	17,0	9,0	40,5	18,2
1213112	R1A25M936W-1008	5/8"	7/8-14	1/2	42,0	17,0	9,0	40,5	18,2
1213113	R1A25M936W-1012	5/8"	7/8-14	3/4	49,0	20,0	11,0	50,8	23,8
1213114	R1A25M936W-1208	3/4"	1 1/16-12	1/2	42,0	20,0	9,0	40,5	18,2
1213115	R1A25M936W-1212	3/4"	1 1/16-12	3/4	51,0	20,0	11,0	50,8	23,8
1213116	R1A25M936W-1216	3/4"	1 1/16-12	1	55,0	25,0	13,0	57,2	27,8
1213117	R1A25M936W-1612	1"	1 5/16-12	3/4	52,0	25,0	11,0	50,8	23,8
1213118	R1A25M936W-1616	1"	1 5/16-12	1	56,0	25,0	13,0	57,2	27,8
1213119	R1A25M936W-1620	1"	1 5/16-12	1 1/4	56,0	31,0	15,0	66,7	31,8
1213120	R1A25M936W-2016	1"1/4	1 5/8-12	1	58,0	31,0	13,0	57,2	27,8
1213121	R1A25M936W-2020	1"1/4	1 5/8-12	1 1/4	63,0	31,0	15,0	66,7	31,8
1213122	R1A25M936W-2024	1"1/4	1 5/8-12	1 1/2	67,0	37,0	17,0	79,4	36,5
1213123	R1A25M936W-2420	1"1/2	1 7/8-12	1 1/4	63,0	37,0	15,0	66,7	31,8
1213124	R1A25M936W-2424	1"1/2	1 7/8-12	1 1/2	70,0	37,0	17,0	79,4	36,5

Design and dimensions shown may be changed without prior notice

// R1A25M9334

90° adjustable split flange SAE J518 code 61

JIC - Low pressure

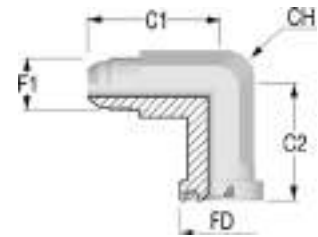

Item Code	Product Code	OD1	F1	F2	FD (mm)	C1 (mm)	C2 (mm)	CH (mm)
1213099	R1A25M9334-0808	1/2"	3/4-16	1/2	30,2	48,0	42,0	22,0
1213100	R1A25M9334-1008	5/8"	7/8-14	1/2	30,2	50,0	44,0	22,0
1213101	R1A25M9334-1012	5/8"	7/8-14	3/4	38,1	64,0	53,0	22,0
1213102	R1A25M9334-1212	3/4"	1 1/16-12	3/4	38,1	64,0	53,0	27,0
1213103	R1A25M9334-1216	3/4"	1 1/16-12	1	44,5	65,0	60,0	27,0
1213104	R1A25M9334-1612	1"	1 5/16-12	3/4	38,1	64,0	53,0	34,0
1213105	R1A25M9334-1616	1"	1 5/16-12	1	44,5	65,0	60,0	34,0
1213106	R1A25M9334-1620	1"	1 5/16-12	1 1/4	50,8	64,0	55,0	34,0
1213107	R1A25M9334-2016	1"1/4	1 5/8-12	1	44,5	65,0	60,0	42,0
1213108	R1A25M9334-2020	1"1/4	1 5/8-12	1 1/4	50,8	64,0	55,0	42,0
1213109	R1A25M9334-2024	1"1/4	1 5/8-12	1 1/2	60,3	78,0	66,0	42,0
1213110	R1A25M9334-2424	1"1/2	1 7/8-12	1 1/2	60,3	78,0	66,0	50,0

// R1A25M9364

90° adjustable split flange SAE J518 code 62

JIC - High pressure

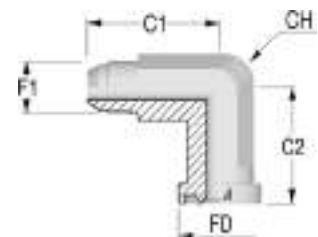

Item Code	Product Code	OD1	F1	F2	FD (mm)	C1 (mm)	C2 (mm)	CH (mm)
1213125	R1A25M9364-0808	1/2"	3/4-16	1/2	31,8	49,0	43,0	22,0
1213126	R1A25M9364-1008	5/8"	7/8-14	1/2	31,8	50,0	44,0	22,0
1213127	R1A25M9364-1012	5/8"	7/8-14	3/4	41,3	64,0	53,0	22,0
1213128	R1A25M9364-1212	3/4"	1 1/16-12	3/4	41,3	64,0	53,0	27,0
1213129	R1A25M9364-1216	3/4"	1 1/16-12	1	47,6	65,0	60,0	27,0
1213130	R1A25M9364-1612	1"	1 5/16-12	3/4	41,3	64,0	53,0	34,0
1213131	R1A25M9364-1616	1"	1 5/16-12	1	47,6	65,0	60,0	34,0
1213132	R1A25M9364-1620	1"	1 5/16-12	1 1/4	54,0	64,0	55,0	34,0
1213133	R1A25M9364-2016	1"1/4	1 5/8-12	1	47,6	65,0	60,0	42,0
1213134	R1A25M9364-2020	1"1/4	1 5/8-12	1 1/4	54,0	64,0	55,0	42,0
1213135	R1A25M9364-2024	1"1/4	1 5/8-12	1 1/2	63,5	78,0	66,0	42,0
1213136	R1A25M9364-2424	1"1/2	1 7/8-12	1 1/2	63,5	78,0	66,0	50,0

// ACCESSORIES

// RXA25D0000

Nut JIC

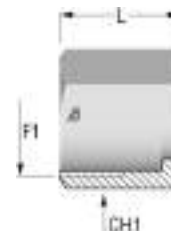

Item Code	Product Code	OD1	F1	L (mm)	CH1 (mm)
1208046	RXA25D0000-0400	6	7/16-20	15,8	14,0
1208047	RXA25D0000-0500	8	1/2-20	17,3	17,0
1207580	RXA25D0000-0600	10	9/16-18	18,8	19,0
1208048	RXA25D0000-0800	12	3/4-16	21,8	22,0
1208049	RXA25D0000-1000	14	7/8-14	25,1	27,0
1208050	RXA25D0000-1200	18	1 1/16-12	26,2	32,0
1203514	RXA25D0000-1220	20	1 1/16-12	26,2	32,0
1208051	RXA25D0000-1600	25	1 5/16-12	28,7	41,0
1208052	RXA25D0000-2000	30	1 5/8-12	31,2	50,0
1208053	RXA25D0000-2400	38	1 7/8-12	36,1	60,0

// R1A25R0000

Sleeve JIC



Item Code	Product Code	OD1	L1 (mm)
1203720	R1A25R0000-1625	1"	20,0
1203723	R1A25R0000-2438	1"1/2	28,5
1203722	R1A25R0000-2032	1"1/4	23,0
1203721	R1A25R0000-2030	1"1/4	23,0
1203724	R1A25R0000-0812	1/2"	14,0
1203725	R1A25R0000-0406	1/4"	10,4
1203717	R1A25R0000-1218	3/4"	17,5
1203718	R1A25R0000-1220	3/4"	17,5
1203729	R1A25R0000-0610	3/8"	12,5
1203719	R1A25R0000-0508	5/16"	11,0
1203728	R1A25R0000-1016	5/8"	17,0
1203727	R1A25R0000-1015	5/8"	17,0
1203726	R1A25R0000-1014	5/8"	17,0
1216495	R1A25R0000-1422	7/8"	19,5

Design and dimensions shown may be changed without prior notice

// PLUG

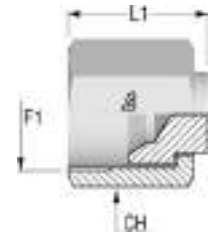
// R1A2531000
Cap JIC Female

Item Code	Product Code	OD1	F1	L1 (mm)	CH (mm)
1207348	R1A2531000-0400	1/4"	7/16-20	17,0	14,0
1207349	R1A2531000-0500	5/16"	1/2-20	19,5	17,0
1207350	R1A2531000-0600	3/8"	9/16-18	20,5	19,0
1207351	R1A2531000-0800	1/2"	3/4-16	24,0	22,0
1207352	R1A2531000-1000	5/8"	7/8-14	27,0	27,0
1207353	R1A2531000-1200	3/4"	1 1/16-12	31,5	32,0
1213213	R1A2531000-1400	7/8"	1 3/16-12	32,0	36,0
1207354	R1A2531000-1600	1"	1 5/16-12	32,5	41,0
1207355	R1A2531000-2000	1"1/4	1 5/8-12	35,5	50,0
1207356	R1A2531000-2400	1"1/2	1 7/8-12	43,0	60,0

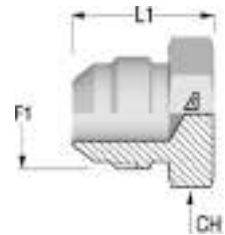
// R1A25M1000
Plug JIC Male

Item Code	Product Code	OD1	F1	L1 (mm)	CH (mm)
1207449	R1A25M1000-0400	1/4"	7/16-20	20,5	12,0
1207450	R1A25M1000-0500	5/16"	1/2-20	20,5	14,0
1207451	R1A25M1000-0600	3/8"	9/16-18	21,5	14,0
1207452	R1A25M1000-0800	1/2"	3/4-16	24,0	22,0
1207453	R1A25M1000-1000	5/8"	7/8-14	28,0	24,0
1207454	R1A25M1000-1200	3/4"	1 1/16-12	32,5	30,0
1212825	R1A25M1000-1400	7/8"	1 3/16-12	33,0	33,0
1207455	R1A25M1000-1600	1"	1 5/16-12	34,0	36,0
1207456	R1A25M1000-2000	1"1/4	1 5/8-12	37,0	46,0
1207457	R1A25M1000-2400	1"1/2	1 7/8-12	42,0	50,0



// ORFS ADAPTERS

// MALE UNION.....	255	// SAE UNF.....	271
// MALE/FEMALE UNION.....	257	// FLANGES.....	275
// BULKHEAD.....	260	// ACCESSORIES.....	278
// BSPP-BSPT.....	263	// PLUG.....	279
// METRIC.....	267		

Design and dimensions shown may be changed without prior notice

// MALE UNION

// R1A2451245

Straight union ORFS Male

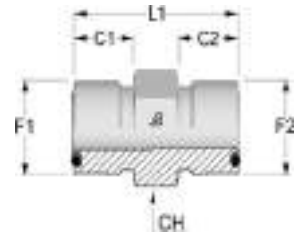

Item Code	Product Code	OD1	F1	F2	C1 (mm)	C2 (mm)	L1 (mm)	CH (mm)
1207586	R1A2451245-0404	1/4"	9/16-18	9/16-18	10,0	10,0	27,0	17,0
1208173	R1A2451245-0604	3/8"	11/16-16	9/16-18	11,0	10,0	30,0	19,0
1207587	R1A2451245-0606	3/8"	11/16-16	11/16-16	11,0	11,0	31,0	19,0
1208174	R1A2451245-0806	1/2"	13/16-16	11/16-16	13,0	11,0	33,5	22,0
1207579	R1A2451245-0808	1/2"	13/16-16	13/16-16	13,0	13,0	35,5	22,0
1208175	R1A2451245-1008	5/8"	1-14	13/16-16	15,5	13,0	40,0	27,0
1207588	R1A2451245-1010	5/8"	1-14	1-14	15,5	15,5	42,5	27,0
1208176	R1A2451245-1210	3/4"	1 3/16-12	1-14	17,0	15,5	45,5	32,0
1207589	R1A2451245-1212	3/4"	1 3/16-12	1 3/16-12	17,0	17,0	47,0	32,0
1208177	R1A2451245-1612	1"	1 7/16-12	1 3/16-12	17,5	17,0	49,5	41,0
1207590	R1A2451245-1616	1"	1 7/16-12	1 7/16-12	17,5	17,5	49,5	41,0
1208179	R1A2451245-2016	1"1/4	1 11/16-12	1 7/16-12	17,5	17,5	51,5	46,0
1208180	R1A2451245-2020	1"1/4	1 11/16-12	1 11/16-12	17,5	17,5	51,5	46,0
1211533	R1A2451245-2424	1"1/2	2-12	2-12	17,5	17,5	53,0	55,0

// R1A2459245

90° union ORFS Male

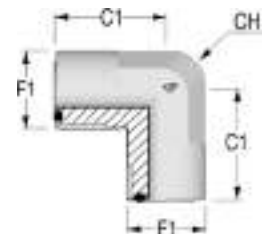

Item Code	Product Code	OD1	F1	C1 (mm)	CH (mm)
1207045	R1A2459245-0404	1/4"	9/16-18	21,5	14,0
1208128	R1A2459245-0606	3/8"	11/16-16	25,0	17,0
1207578	R1A2459245-0808	1/2"	13/16-16	28,0	19,0
1208129	R1A2459245-1010	5/8"	1-14	33,5	27,0
1208130	R1A2459245-1212	3/4"	1 3/16-12	37,5	27,0
1208131	R1A2459245-1616	1"	1 7/16-12	42,0	36,0
1208132	R1A2459245-2020	1"1/4	1 11/16-12	45,0	41,0
1211560	R1A2459245-2424	1"1/2	2-12	49,0	48,0

// R1A245T245

Branch Tee union ORFS Male

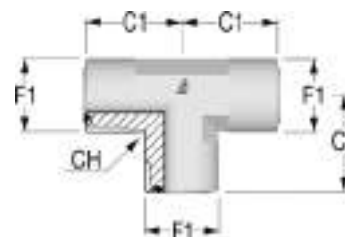

Item Code	Product Code	OD1	F1	C1 (mm)	CH (mm)
1207600	R1A245T245-0404	1/4"	9/16-18	21,5	14,0
1207601	R1A245T245-0606	3/8"	11/16-16	25,0	17,0
1207572	R1A245T245-0808	1/2"	13/16-16	28,0	19,0
1207571	R1A245T245-1010	5/8"	1-14	33,5	27,0
1208205	R1A245T245-1212	3/4"	1 3/16-12	37,5	27,0
1207602	R1A245T245-1616	1"	1 7/16-12	42,0	36,0
1208206	R1A245T245-2020	1 1/4"	1 11/16-12	45,0	41,0
1211520	R1A245T245-2424	1 1/2"	2-12	49,0	48,0

// R1A245X245

Cross union ORFS Male

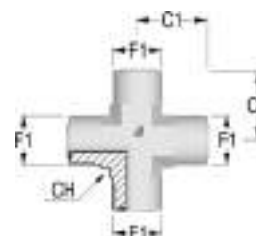

Item Code	Product Code	OD1	F1	C1 (mm)	CH (mm)
1212531	R1A245X245-0404	1/4"	9/16-18	21,5	14,0
1212532	R1A245X245-0606	3/8"	11/16-16	25,0	17,0
1212533	R1A245X245-0808	1/2"	13/16-16	28,0	19,0
1212534	R1A245X245-1010	5/8"	1-14	33,5	27,0
1212535	R1A245X245-1212	3/4"	1 3/16-12	37,5	27,0
1212536	R1A245X245-1616	1"	1 7/16-12	42,0	36,0
1212537	R1A245X245-2020	1 1/4"	1 11/16-12	45,0	41,0
1212538	R1A245X245-2424	1 1/2"	2-12	49,0	48,0

Design and dimensions shown may be changed without prior notice

// MALE/FEMALE UNION

// R1A2431245

Straight union ORFS Female - Male

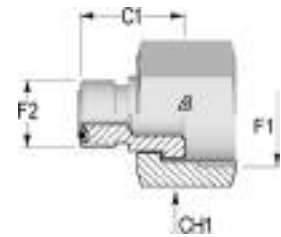

Item Code	Product Code	OD1	F1	F2	C1 (mm)	CH1 (mm)
1212498	R1A2431245-0604	3/8"	11/16-16	9/16-18	19,5	22,0
1208210	R1A2431245-0804	1/2"	13/16-16	9/16-18	22,0	24,0
1208347	R1A2431245-0806	1/2"	13/16-16	11/16-16	23,0	24,0
1207033	R1A2431245-1004	5/8"	1-14	9/16-18	23,0	30,0
1212518	R1A2431245-1006	5/8"	1-14	11/16-16	24,0	30,0
1207660	R1A2431245-1008	5/8"	1-14	13/16-16	26,0	30,0
1212519	R1A2431245-1204	3/4"	1 3/16-12	9/16-18	25,0	36,0
1208211	R1A2431245-1206	3/4"	1 3/16-12	11/16-16	26,0	36,0
1208212	R1A2431245-1208	3/4"	1 3/16-12	13/16-16	28,0	36,0
1214621	R1A2431245-1210	3/4"	1 3/16-12	1-14	30,5	36,0
1208213	R1A2431245-1608	1"	1 7/16-12	13/16-16	29,5	41,0
1207661	R1A2431245-1610	1"	1 7/16-12	1-14	32,0	41,0
1212499	R1A2431245-1612	1"	1 7/16-12	1 3/16-12	33,5	41,0
1208214	R1A2431245-2012	1 1/4"	1 11/16-12	13/16-16	33,5	50,0
1208037	R1A2431245-2016	1 1/4"	1 11/16-12	1 7/16-12	38,5	50,0
1211497	R1A2431245-2416	1 1/2"	2-12	1 7/16-12	34,0	60,0
1211498	R1A2431245-2420	1 1/2"	2-12	1 11/16-12	34,0	60,0

257

// R1A2454241

45° union ORFS Male - Female

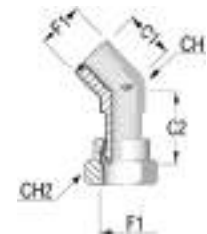

Item Code	Product Code	OD1	F1	C1 (mm)	C2 (mm)	CH (mm)	CH2 (mm)
1212613	R1A2454241-0404	1/4"	9/16-18	16,0	26,5	14,0	17,0
1212614	R1A2454241-0606	3/8"	11/16-16	19,0	25,0	17,0	22,0
1212615	R1A2454241-0808	1/2"	13/16-16	20,5	30,0	19,0	24,0
1212616	R1A2454241-1010	5/8"	1-14	23,5	36,0	27,0	30,0
1211542	R1A2454241-1212	3/4"	1 3/16-12	26,0	41,0	27,0	36,0
1212617	R1A2454241-1616	1"	1 7/16-12	30,0	45,0	36,0	41,0
1212618	R1A2454241-2020	1 1/4"	1 11/16-12	32,0	45,0	41,0	50,0
1212619	R1A2454241-2424	1 1/2"	2-12	32,0	47,5	48,0	60,0

ADAPTERS

// R1A2459241

90° union ORFS Male - Female



Item Code	Product Code	OD1	F1	C1 (mm)	C2 (mm)	CH (mm)	CH2 (mm)
1208021	R1A2459241-0404	1/4"	9/16-18	21,5	26,5	14,0	17,0
1207593	R1A2459241-0606	3/8"	11/16-16	25,0	29,0	17,0	22,0
1207569	R1A2459241-0808	1/2"	13/16-16	28,0	38,0	19,0	24,0
1206968	R1A2459241-1010	5/8"	1-14	33,5	41,5	27,0	30,0
1207594	R1A2459241-1212	3/4"	1 3/16-12	37,5	46,5	27,0	36,0
1207595	R1A2459241-1616	1"	1 7/16-12	41,5	53,5	36,0	41,0
1208126	R1A2459241-2020	1 1/4"	1 11/16-12	44,5	58,0	41,0	50,0
1211559	R1A2459241-2424	1 1/2"	2-12	49,0	61,0	48,0	60,0

// R1A245T241

Branch Tee union ORFS Male - Female

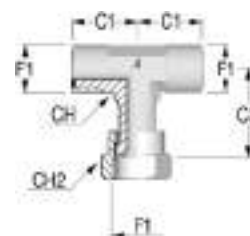

Item Code	Product Code	OD1	F1	C1 (mm)	C3 (mm)	CH (mm)	CH2 (mm)
1208200	R1A245T241-0404	1/4"	9/16-18	21,5	26,5	14,0	17,0
1208033	R1A245T241-0606	3/8"	11/16-16	25,0	29,0	17,0	22,0
1207570	R1A245T241-0808	1/2"	13/16-16	28,0	38,0	19,0	24,0
1208201	R1A245T241-1010	5/8"	1-14	33,5	41,5	27,0	30,0
1208202	R1A245T241-1212	3/4"	1 3/16-12	37,5	46,5	27,0	36,0
1208203	R1A245T241-1616	1"	1 7/16-12	41,5	53,5	36,0	41,0
1208204	R1A245T241-2020	1 1/4"	1 11/16-12	44,5	58,0	41,0	50,0
1211519	R1A245T241-2424	1 1/2"	2-12	49,0	61,0	48,0	60,0

Design and dimensions shown may be changed without prior notice

// R1A245L241

Run Tee union ORFS Male - Female

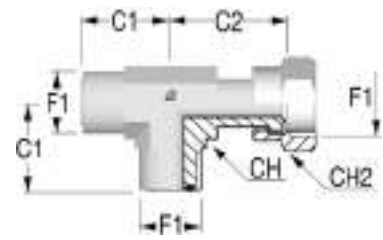

Item Code	Product Code	OD1	F1	C1 (mm)	C2 (mm)	CH (mm)	CH2 (mm)
1207597	R1A245L241-0404	1/4"	9/16-18	21,5	26,5	14,0	19,0
1207573	R1A245L241-0606	3/8"	11/16-16	25,0	29,0	17,0	22,0
1207598	R1A245L241-0808	1/2"	13/16-16	28,0	38,0	19,0	27,0
1207032	R1A245L241-1010	5/8"	1-14	33,5	41,5	27,0	30,0
1207559	R1A245L241-1212	3/4"	1 3/16-12	37,5	46,5	27,0	36,0
1207599	R1A245L241-1616	1"	1 7/16-12	41,5	53,5	36,0	41,0
1208209	R1A245L241-2020	1"1/4	1 11/16-12	44,0	58,0	41,0	50,0
1211508	R1A245L241-2424	1"1/2	2-12	48,5	61,0	48,0	60,0

// BULKHEAD

// R1A245124T

Straight union ORFS Bulkhead

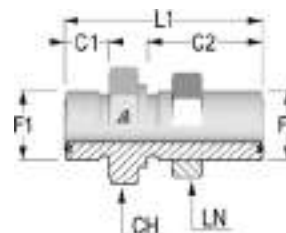

Item Code	Product Code	OD1	F1	C1 (mm)	C2 (mm)	L1 (mm)	CH (mm)	LN (mm)
1208184	R1A245124T-0404	1/4"	9/16-18	10,0	30,0	48,0	22,0	22,0
1207035	R1A245124T-0606	3/8"	11/16-16	11,0	32,5	53,0	27,0	27,0
1208185	R1A245124T-0808	1/2"	13/16-16	13,0	34,0	58,0	30,0	30,0
1239974	R1A245124T-0812	1/2"	13/16-16	13,0	38,5	65,0	41,0	41,0
1206967	R1A245124T-1010	5/8"	1-14	15,5	38,0	65,5	36,0	36,0
1208187	R1A245124T-1212	3/4"	1 3/16-12	17,0	38,5	69,0	41,0	41,0
1208188	R1A245124T-1616	1"	1 7/16-12	17,5	39,0	70,0	46,0	46,0
1208189	R1A245124T-2020	1"1/4	1 11/16-12	17,5	39,0	70,0	50,0	50,0
1211532	R1A245124T-2424	1"1/2	2-12	17,5	39,0	70,0	60,0	60,0

// R1A245424T

45° union ORFS Bulkhead

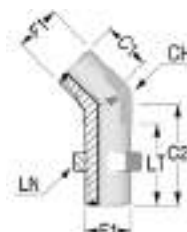

Item Code	Product Code	OD1	F1	C1 (mm)	C2 (mm)	LT (mm)	CH (mm)	LN (mm)
1212605	R1A245424T-0404	1/4"	9/16-18	16,0	44,0	31,5	14,0	22,0
1212606	R1A245424T-0606	3/8"	11/16-16	19,0	48,5	34,0	17,0	27,0
1212607	R1A245424T-0808	1/2"	13/16-16	20,5	51,0	36,5	19,0	30,0
1212608	R1A245424T-1010	5/8"	1-14	23,5	56,5	40,5	27,0	36,0
1212609	R1A245424T-1212	3/4"	1 3/16-12	26,0	60,5	41,5	27,0	41,0
1212610	R1A245424T-1616	1"	1 7/16-12	30,0	65,0	42,0	36,0	46,0
1212612	R1A245424T-2424	1"1/2	2-12	37,0	67,0	42,0	48,0	60,0

Design and dimensions shown may be changed without prior notice

// R1A245924T

90° union ORFS Bulkhead

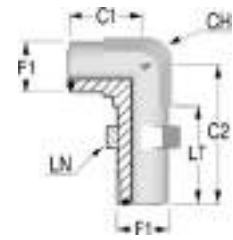

Item Code	Product Code	OD1	F1	C1 (mm)	C2 (mm)	LT (mm)	CH (mm)	LN (mm)
1210753	R1A245924T-0404	1/4"	9/16-18	22,5	47,0	31,5	14,0	22,0
1210754	R1A245924T-0606	3/8"	11/16-16	26,0	52,0	34,0	17,0	27,0
1210755	R1A245924T-0808	1/2"	13/16-16	29,0	55,5	36,5	19,0	30,0
1207560	R1A245924T-1010	5/8"	1-14	34,5	63,0	40,5	27,0	36,0
1208157	R1A245924T-1212	3/4"	1 3/16-12	38,5	67,0	41,5	27,0	41,0
1211557	R1A245924T-1616	1"	1 7/16-12	42,5	71,0	42,0	36,0	46,0
1208158	R1A245924T-2020	1"1/4	1 11/16-12	45,5	75,5	42,0	41,0	50,0
1211558	R1A245924T-2424	1"1/2	2-12	49,5	79,5	42,0	48,0	60,0

// R1A245T24T

Branch Tee union ORFS Bulkhead

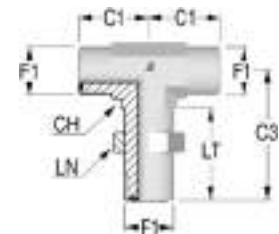

Item Code	Product Code	OD1	F1	C1 (mm)	C3 (mm)	LT (mm)	CH (mm)	LN (mm)
1212524	R1A245T24T-0404	1/4"	9/16-18	22,5	47,0	31,5	14,0	22,0
1212525	R1A245T24T-0606	3/8"	11/16-16	26,0	52,0	34,0	17,0	27,0
1208224	R1A245T24T-0808	1/2"	13/16-16	29,0	55,5	36,5	19,0	30,0
1212526	R1A245T24T-1010	5/8"	1-14	34,5	63,0	40,5	27,0	36,0
1212527	R1A245T24T-1212	3/4"	1 3/16-12	38,5	67,0	41,5	27,0	41,0
1212528	R1A245T24T-1616	1"	1 7/16-12	42,5	71,0	42,0	36,0	46,0
1212529	R1A245T24T-2020	1"1/4	1 11/16-12	45,5	75,5	42,0	41,0	50,0
1212530	R1A245T24T-2424	1"1/2	2-12	49,5	79,5	42,0	48,0	60,0

// R1A245L24T

Run Tee union ORFS Bulkhead

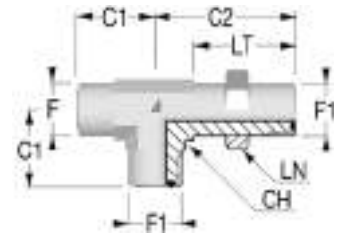

Item Code	Product Code	OD1	F1	C1 (mm)	C2 (mm)	LT (mm)	CH (mm)	LN (mm)
1240057	R1A245L24T-0404	1/4"	9/16-18	22,5	47,0	35,0	14,0	22,0
1211502	R1A245L24T-0606	3/8"	11/16-16	26,0	52,0	39,0	17,0	27,0
1210797	R1A245L24T-0808	1/2"	13/16-16	29,0	55,5	40,0	19,0	30,0
1211503	R1A245L24T-1010	5/8"	1-14	34,5	63,0	43,5	27,0	36,0
1211504	R1A245L24T-1212	3/4"	1 3/16-12	38,5	67,0	44,5	27,0	41,0
1211505	R1A245L24T-1616	1"	1 7/16-12	42,5	71,0	46,0	36,0	46,0
1211506	R1A245L24T-2020	1"1/4	1 11/16-12	45,5	75,5	46,5	41,0	50,0
1211507	R1A245L24T-2424	1"1/2	2-12	49,5	79,5	45,0	48,0	60,0

Design and dimensions shown may be changed without prior notice

// BSPP-BSPT

// R1A245106I

Straight connector

ORFS Male - BSPP cylindric Male with elastomer

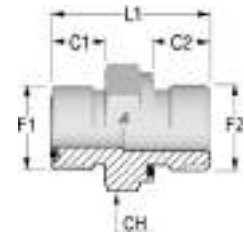

Item Code	Product Code	OD1	F1	F2	C1 (mm)	C2 (mm)	L1 (mm)	CH (mm)
1207990	R1A245106I-0402	1/4"	9/16-18	1/8-28	10,0	8,0	25,5	17,0
1206956	R1A245106I-0404	1/4"	9/16-18	1/4-19	10,0	12,0	30,5	19,0
1206957	R1A245106I-0406	1/4"	9/16-18	3/8-19	10,0	12,0	31,5	22,0
1208017	R1A245106I-0408	1/4"	9/16-18	1/2-14	10,0	14,0	35,5	27,0
1207575	R1A245106I-0604	3/8"	11/16-16	1/4-19	11,0	12,0	31,5	19,0
1207574	R1A245106I-0606	3/8"	11/16-16	3/8-19	11,0	12,0	33,5	22,0
1207996	R1A245106I-0608	3/8"	11/16-16	1/2-14	11,0	14,0	37,0	27,0
1207998	R1A245106I-0804	1/2"	13/16-16	1/4-19	13,0	12,0	39,5	22,0
1207576	R1A245106I-0806	1/2"	13/16-16	3/8-19	13,0	12,0	34,5	22,0
1206958	R1A245106I-0808	1/2"	13/16-16	1/2-14	13,0	14,0	38,5	27,0
1208022	R1A245106I-0812	1/2"	13/16-16	3/4-14	13,0	16,0	42,0	32,0
1207999	R1A245106I-1006	5/8"	1-14	3/8-19	15,5	12,0	43,0	27,0
1208010	R1A245106I-1008	5/8"	1-14	1/2-14	15,5	14,0	41,0	27,0
1207959	R1A245106I-1012	5/8"	1-14	3/4-14	15,5	16,0	44,5	32,0
1208000	R1A245106I-1208	3/4"	1 3/16-12	1/2-14	17,0	14,0	48,5	32,0
1206955	R1A245106I-1212	3/4"	1 3/16-12	3/4-14	17,0	16,0	46,0	32,0
1211527	R1A245106I-1216	3/4"	1 3/16-12	1-11	17,0	18,0	49,5	41,0
1208003	R1A245106I-1612	1"	1 7/16-12	3/4-14	17,5	16,0	51,0	41,0
1207577	R1A245106I-1616	1"	1 7/16-12	1-11	17,5	18,0	49,0	41,0
1207979	R1A245106I-1620	1"	1 7/16-12	1 1/4-11	17,5	20,0	54,0	50,0
1208034	R1A245106I-2016	1 1/4"	1 11/16-12	1-11	17,5	18,0	57,5	46,0
1208018	R1A245106I-2020	1 1/4"	1 11/16-12	1 1/4-11	17,5	20,0	54,0	50,0
1211528	R1A245106I-2024	1 1/4"	1 11/16-12	1 1/2-11	17,5	22,0	57,5	55,0
1211529	R1A245106I-2424	1 1/2"	2-12	1 1/2-11	17,5	22,0	57,5	55,0

// R1A245406N

45° adjustable elbow connector

ORFS Male - BSPP cylindric Male with O-Ring and retaining ring



Item Code	Product Code	OD1	F1	F2	C1 (mm)	C2 (mm)	CH (mm)	LN (mm)
1210800	R1A245406N-0402	1/4"	9/16-18	1/8-28	16,0	28,0	14,0	14,0
1210801	R1A245406N-0404	1/4"	9/16-18	1/4-19	17,5	31,0	14,0	19,0
1210802	R1A245406N-0604	3/8"	11/16-16	1/4-19	19,0	32,0	19,0	19,0
1210803	R1A245406N-0606	3/8"	11/16-16	3/8-19	19,0	33,0	19,0	22,0
1210804	R1A245406N-0608	3/8"	11/16-16	1/2-14	19,5	43,0	27,0	27,0
1210805	R1A245406N-0806	1/2"	13/16-16	3/8-19	20,5	33,5	19,0	22,0
1212604	R1A245406N-0808	1/2"	13/16-16	1/2-14	22,0	42,0	27,0	27,0
1210806	R1A245406N-1008	5/8"	1-14	1/2-14	23,5	42,0	27,0	27,0
1210807	R1A245406N-1012	5/8"	1-14	3/4-14	24,5	46,5	30,0	36,0
1210733	R1A245406N-1212	3/4"	1 3/16-12	3/4-14	26,0	50,0	30,0	36,0
1211539	R1A245406N-1216	3/4"	1 3/16-12	1-11	29,5	52,5	36,0	41,0
1207720	R1A245406N-1616	1"	1 7/16-12	1-11	30,0	52,5	36,0	41,0
1211540	R1A245406N-2020	1"1/4	1 11/16-12	1 1/4-11	32,0	53,5	41,0	50,0
1211541	R1A245406N-2424	1"1/2	2-12	1 1/2-11	37,0	53,5	48,0	55,0

// R1A245906N

90° adjustable elbow connector

ORFS Male - BSPP cylindric Male with O-Ring and retaining ring

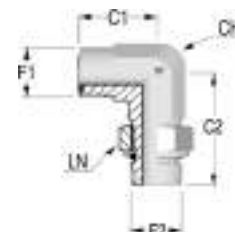

Item Code	Product Code	OD1	F1	F2	C1 (mm)	C2 (mm)	CH (mm)	LN (mm)
1210739	R1A245906N-0402	1/4"	9/16-18	1/8-28	21,5	30,0	14,0	14,0
1207721	R1A245906N-0404	1/4"	9/16-18	1/4-19	23,5	35,0	14,0	19,0
1207581	R1A245906N-0406	1/4"	9/16-18	3/8-19	25,0	38,0	19,0	22,0
1248244	R1A245906N-0604	3/8"	11/16-16	1/4-19	25,0	38,0	19,0	19,0
1207568	R1A245906N-0606	3/8"	11/16-16	3/8-19	26,5	38,0	19,0	22,0
1207567	R1A245906N-0608	3/8"	11/16-16	1/2-14	29,5	48,0	27,0	27,0
1207723	R1A245906N-0804	1/2"	13/16-16	1/4-19	28,0	35,0	19,0	19,0
1207724	R1A245906N-0806	1/2"	13/16-16	3/8-19	28,0	38,0	19,0	22,0
1207725	R1A245906N-0808	1/2"	13/16-16	1/2-14	31,0	48,0	27,0	27,0
1208118	R1A245906N-1006	5/8"	1-14	3/8-19	33,5	43,0	27,0	22,0
1207034	R1A245906N-1008	5/8"	1-14	1/2-14	33,5	48,0	27,0	27,0
1210741	R1A245906N-1012	5/8"	1-14	3/4-14	36,0	51,5	30,0	36,0
1208029	R1A245906N-1208	3/4"	1 3/16-12	1/2-14	37,5	49,5	30,0	27,0
1207557	R1A245906N-1212	3/4"	1 3/16-12	3/4-14	37,5	51,5	30,0	36,0
1208119	R1A245906N-1216	3/4"	1 3/16-12	1-11	41,5	58,0	36,0	41,0
1210714	R1A245906N-1612	1"	1 7/16-12	3/4-14	42,0	56,0	36,0	36,0
1208121	R1A245906N-1616	1"	1 7/16-12	1-11	42,0	63,5	36,0	41,0
1211552	R1A245906N-1620	1"	1 7/16-12	1 1/4-11	45,0	60,5	41,0	50,0
1211553	R1A245906N-2016	1"1/4	1 11/16-12	1-11	45,0	60,0	41,0	41,0
1211554	R1A245906N-2020	1"1/4	1 11/16-12	1 1/4-11	45,0	67,5	41,0	50,0
1211555	R1A245906N-2024	1"1/4	1 11/16-12	1 1/2-11	49,0	64,5	48,0	55,0
1211556	R1A245906N-2424	1"1/2	2-12	1 1/2-11	49,0	64,5	48,0	55,0

Design and dimensions shown may be changed without prior notice

// R1A245906Y

90° adjustable long elbow connector

ORFS Male - BSPP cylindric Male with O-Ring and retaining ring

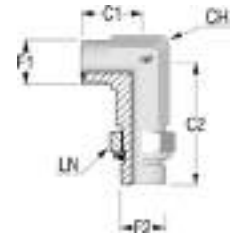

Item Code	Product Code	OD1	F1	F2	C1 (mm)	C2 (mm)	CH (mm)	LN (mm)
1212620	R1A245906Y-0404	1/4"	9/16-18	1/4-19	23,5	59,0	14,0	19,0
1212621	R1A245906Y-0406	1/4"	9/16-18	3/8-19	25,0	62,0	22,0	22,0
1212622	R1A245906Y-0606	3/8"	11/16-16	3/8-19	26,5	67,0	22,0	22,0
1212623	R1A245906Y-0608	3/8"	11/16-16	1/2-14	36,5	93,1	27,0	27,0
1212624	R1A245906Y-0806	1/2"	13/16-16	3/8-19	28,0	73,0	22,0	22,0
1212625	R1A245906Y-0808	1/2"	13/16-16	1/2-14	31,0	82,0	27,0	27,0
1212626	R1A245906Y-1008	5/8"	1-14	1/2-14	33,0	82,0	27,0	27,0
1212627	R1A245906Y-1012	5/8"	1-14	3/4-14	36,0	90,0	33,0	36,0
1212628	R1A245906Y-1212	3/4"	1 3/16-12	3/4-14	37,5	97,0	33,0	36,0
1212629	R1A245906Y-1216	3/4"	1 3/16-12	1-11	41,5	104,0	36,0	41,0
1212630	R1A245906Y-1616	1"	1 7/16-12	1-11	42,0	112,0	36,0	41,0
1212631	R1A245906Y-1620	1"	1 7/16-12	1 1/4-11	45,0	113,0	41,0	50,0
1212632	R1A245906Y-2020	1"1/4	1 11/16-12	1 1/4-11	45,0	113,0	41,0	50,0
1212633	R1A245906Y-2024	1"1/4	1 11/16-12	1 1/2-11	45,0	113,0	41,0	50,0
1212634	R1A245906Y-2424	1"1/2	2-12	1 1/2-11	49,0	137,0	48,0	55,0

// R1A245T06N

Branch Tee adjustable elbow connector

ORFS Male - BSPP cylindric Male with O-Ring and retaining ring

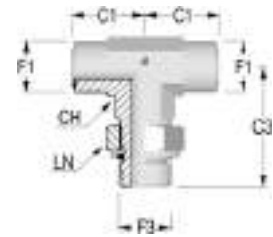

Item Code	Product Code	OD1	F1	F3	C1 (mm)	C3 (mm)	CH (mm)	LN (mm)
1210825	R1A245T06N-0402	1/4"	9/16-18	1/8-28	21,5	30,0	14,0	14,0
1210826	R1A245T06N-0404	1/4"	9/16-18	1/4-19	23,5	35,0	14,0	19,0
1210827	R1A245T06N-0604	3/8"	11/16-16	1/4-19	25,0	36,0	17,0	19,0
1210828	R1A245T06N-0606	3/8"	11/16-16	3/8-19	26,5	38,0	17,0	22,0
1210829	R1A245T06N-0806	1/2"	13/16-16	3/8-19	28,0	38,0	19,0	22,0
1212523	R1A245T06N-0808	1/2"	13/16-16	1/2-14	31,0	48,0	22,0	27,0
1207726	R1A245T06N-1008	5/8"	1-14	1/2-14	33,5	48,0	27,0	27,0
1210830	R1A245T06N-1012	5/8"	1-14	3/4-14	36,0	51,5	30,0	36,0
1207558	R1A245T06N-1212	3/4"	1 3/16-12	3/4-14	37,5	51,5	30,0	36,0
1211516	R1A245T06N-1616	1"	1 7/16-12	1-11	42,0	58,0	36,0	41,0
1211517	R1A245T06N-2020	1"1/4	1 11/16-12	1 1/4-11	45,0	60,5	41,0	50,0
1211518	R1A245T06N-2424	1"1/2	2-12	1 1/2-11	49,0	64,5	48,0	55,0

// R1A245L06N

Run Tee adjustable elbow connector

ORFS Male - BSPP cylindric Male with O-Ring and retaining ring

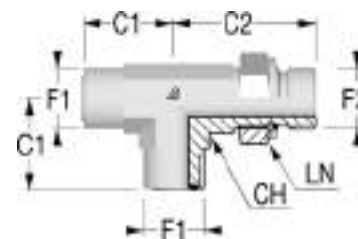

Item Code	Product Code	OD1	F1	F2	C1 (mm)	C2 (mm)	CH (mm)	LN (mm)
1210789	R1A245L06N-0402	1/4"	9/16-18	1/8-28	21,5	30,0	14,0	14,0
1210790	R1A245L06N-0404	1/4"	9/16-18	1/4-19	23,5	35,0	14,0	19,0
1210791	R1A245L06N-0604	3/8"	11/16-16	1/4-19	25,0	36,0	17,0	19,0
1210792	R1A245L06N-0606	3/8"	11/16-16	3/8-19	26,5	38,0	17,0	22,0
1211499	R1A245L06N-0806	1/2"	13/16-16	3/8-19	28,0	38,0	19,0	22,0
1210793	R1A245L06N-0808	1/2"	13/16-16	1/2-14	31,0	48,0	22,0	27,0
1210794	R1A245L06N-1008	5/8"	1-14	1/2-14	33,5	48,0	27,0	27,0
1210795	R1A245L06N-1012	5/8"	1-14	3/4-14	38,0	51,5	30,0	36,0
1210796	R1A245L06N-1212	3/4"	1 3/16-12	3/4-14	37,5	51,5	30,0	36,0
1208208	R1A245L06N-1616	1"	1 7/16-12	1-11	42,0	58,0	36,0	41,0
1211500	R1A245L06N-2020	1"1/4	1 11/16-12	1 1/4-11	45,0	60,5	41,0	50,0
1211501	R1A245L06N-2424	1"1/2	2-12	1 1/2-11	49,0	64,5	48,0	55,0

Design and dimensions shown may be changed without prior notice

// METRIC

// R1A2451525

Straight connector

ORFS Male - Metric Male with O-Ring

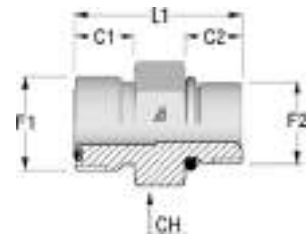

Item Code	Product Code	OD1	F1	F2	C1 (mm)	C2 (mm)	L1 (mm)	CH (mm)
1216267	R1A2451525-0410	1/4"	9/16-18	M10X1.0	10,0	12,0	27,0	17,0
1216268	R1A2451525-0412	1/4"	9/16-18	M12X1.5	10,0	13,5	28,5	17,0
1208019	R1A2451525-0414	1/4"	9/16-18	M14X1.5	10,0	13,5	29,5	19,0
1207957	R1A2451525-0614	3/8"	11/16-16	M14X1.5	11,0	13,5	32,0	22,0
1208032	R1A2451525-0616	3/8"	11/16-16	M16X1.5	11,0	15,0	33,5	22,0
1216270	R1A2451525-0618	3/8"	11/16-16	M18X1.5	11,0	16,5	36,0	24,0
1207956	R1A2451525-0814	1/2"	13/16-16	M14X1.5	13,0	13,5	35,0	22,0
1216272	R1A2451525-0816	1/2"	13/16-16	M16X1.5	13,0	15,0	36,5	24,0
1208040	R1A2451525-0818	1/2"	13/16-16	M18X1.5	13,0	16,5	38,0	24,0
1211538	R1A2451525-0822	1/2"	13/16-16	M22X1.5	13,0	17,5	39,0	27,0
1208020	R1A2451525-1022	5/8"	1-14	M22X1.5	15,5	17,5	42,0	27,0
1216274	R1A2451525-1027	5/8"	1-14	M27X2	15,5	18,5	46,0	32,0
1216276	R1A2451525-1227	3/4"	1 3/16-12	M27X2	17,0	21,0	48,5	32,0
1216277	R1A2451525-1233	3/4"	1 3/16-12	M33X2.0	17,0	21,5	51,5	41,0
1216278	R1A2451525-1633	1"	1 7/16-12	M33X2.0	17,5	21,5	52,0	41,0
1216279	R1A2451525-1642	1"	1 7/16-12	M42X2	17,5	22,0	54,5	50,0
1216280	R1A2451525-2042	1"1/4	1 11/16-12	M42X2	17,5	22,0	54,5	50,0
1216281	R1A2451525-2048	1"1/4	1 11/16-12	M48X2.0	17,5	24,5	55,5	55,0
1216282	R1A2451525-2448	1"1/2	2-12	M48X2.0	17,5	24,5	57,0	55,0

// R1A245152I

Straight connector

ORFS Male - Metric Male with elastomer

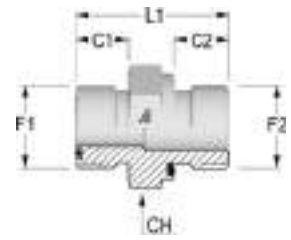

Item Code	Product Code	OD1	F1	F2	C1 (mm)	C2 (mm)	L1 (mm)	CH (mm)
1206959	R1A245152I-0410	1/4"	9/16-18	M10X1.0	10,0	8,0	25,0	17,0
1206960	R1A245152I-0412	1/4"	9/16-18	M12X1.5	10,0	12,0	29,5	17,0
1208035	R1A245152I-0414	1/4"	9/16-18	M14X1.5	10,0	12,0	30,5	19,0
1208036	R1A245152I-0614	3/8"	11/16-16	M14X1.5	11,0	12,0	32,0	22,0
1206961	R1A245152I-0616	3/8"	11/16-16	M16X1.5	11,0	12,0	32,0	22,0
1212592	R1A245152I-0814	1/2"	13/16-16	M14X1.5	13,0	12,0	34,0	22,0
1216283	R1A245152I-0816	1/2"	13/16-16	M16X1.5	13,0	12,0	34,0	22,0
1206962	R1A245152I-0818	1/2"	13/16-16	M18X1.5	13,0	12,0	36,5	24,0
1212593	R1A245152I-0822	1/2"	13/16-16	M22X1.5	13,0	14,0	38,5	27,0
1208191	R1A245152I-1022	5/8"	1-14	M22X1.5	15,5	14,0	41,0	27,0
1212594	R1A245152I-1222	3/4"	1 3/16-12	M22X1.5	17,0	14,0	44,0	32,0
1208192	R1A245152I-1227	3/4"	1 3/16-12	M27X2	17,0	16,0	46,0	32,0
1211535	R1A245152I-1633	1"	1 7/16-12	M33X2.0	17,5	18,0	50,0	41,0
1212597	R1A245152I-1642	1"	1 7/16-12	M42X2	17,5	20,0	54,0	50,0
1211536	R1A245152I-2042	1"1/4	1 11/16-12	M42X2	17,5	20,0	54,0	50,0
1211537	R1A245152I-2448	1"1/2	2-12	M48X2.0	17,5	22,0	57,5	55,0

// R1A245452Q

45° adjustable elbow connector

ORFS Male - Metric Male with O-Ring and retaining ring

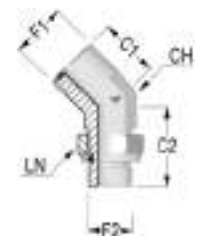

Item Code	Product Code	OD1	F1	F2	C1 (mm)	C2 (mm)	CH (mm)	LN (mm)
1210736	R1A245452Q-0412	1/4"	9/16-18	M12X1.5	16,0	30,0	14,0	17,0
1208115	R1A245452Q-0616	3/8"	11/16-16	M16X1.5	19,0	33,5	17,0	22,0
1210737	R1A245452Q-0818	1/2"	13/16-16	M18X1.5	20,5	37,0	19,0	24,0
1210738	R1A245452Q-1022	5/8"	1-14	M22X1.5	23,5	44,0	27,0	27,0
1211548	R1A245452Q-1227	3/4"	1 3/16-12	M27X2	26,0	50,5	27,0	32,0
1211549	R1A245452Q-1633	1"	1 7/16-12	M33X2.0	30,0	52,5	36,0	41,0
1211550	R1A245452Q-2042	1"1/4	1 11/16-12	M42X2	32,0	54,0	41,0	50,0
1211551	R1A245452Q-2448	1"1/2	2-12	M48X2.0	37,0	56,5	48,0	55,0

Design and dimensions shown may be changed without prior notice

// R1A245952Q

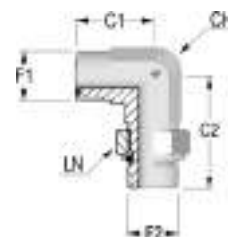
90° adjustable elbow connector**ORFS Male - Metric Male with O-Ring and retaining ring**

Item Code	Product Code	OD1	F1	F2	C1 (mm)	C2 (mm)	CH (mm)	LN (mm)
1210758	R1A245952Q-0410	1/4"	9/16-18	M10X1.0	21,5	30,5	14,0	14,0
1208159	R1A245952Q-0412	1/4"	9/16-18	M12X1.5	21,5	33,0	14,0	17,0
1212692	R1A245952Q-0612	3/8"	11/16-16	M12X1.5	25,0	35,5	17,0	17,0
1208042	R1A245952Q-0614	3/8"	11/16-16	M14X1.5	25,0	35,5	17,0	19,0
1208043	R1A245952Q-0616	3/8"	11/16-16	M16X1.5	25,0	37,5	17,0	22,0
1210759	R1A245952Q-0818	1/2"	13/16-16	M18X1.5	28,0	41,0	19,0	24,0
1210760	R1A245952Q-0822	1/2"	13/16-16	M22X1.5	31,0	49,0	19,0	27,0
1210761	R1A245952Q-1022	5/8"	1-14	M22X1.5	33,5	49,0	27,0	27,0
1210762	R1A245952Q-1027	5/8"	1-14	M27X2	33,5	55,0	27,0	32,0
1210763	R1A245952Q-1227	3/4"	1 3/16-12	M27X2	37,5	55,5	27,0	32,0
1210764	R1A245952Q-1233	3/4"	1 3/16-12	M33X2.0	37,5	59,5	36,0	41,0
1212693	R1A245952Q-1627	1"	1 7/16-12	M27X2	41,5	59,5	36,0	32,0
1211568	R1A245952Q-1633	1"	1 7/16-12	M33X2.0	41,5	59,5	36,0	41,0
1211569	R1A245952Q-1642	1"	1 7/16-12	M42X2	41,5	62,0	41,0	50,0
1211570	R1A245952Q-2042	1"1/4	1 11/16-12	M42X2	43,5	63,0	41,0	50,0
1211571	R1A245952Q-2048	1"1/4	1 11/16-12	M48X2.0	44,5	71,5	48,0	55,0
1211572	R1A245952Q-2448	1"1/2	2-12	M48X2.0	44,5	66,0	48,0	55,0

// R1A245952Y

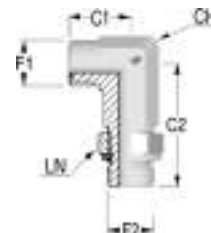
90° adjustable long elbow connector**ORFS Male - Metric Male with O-Ring and retaining ring**

Item Code	Product Code	OD1	F1	F2	C1 (mm)	C2 (mm)	CH (mm)	LN (mm)
1212694	R1A245952Y-0412	1/4"	9/16-18	M12X1.5	21,5	56,5	14,0	17,0
1212695	R1A245952Y-0616	3/8"	11/16-16	M16X1.5	25,0	67,0	17,0	22,0
1212696	R1A245952Y-0818	1/2"	13/16-16	M18X1.5	28,0	75,0	19,0	24,0
1212697	R1A245952Y-1022	5/8"	1-14	M22X1.5	33,5	89,0	27,0	27,0
1212698	R1A245952Y-1227	3/4"	1 3/16-12	M27X2	37,5	100,0	27,0	32,0
1212699	R1A245952Y-1633	1"	1 7/16-12	M33X2.0	41,5	113,0	36,0	41,0
1212700	R1A245952Y-2042	1"1/4	1 11/16-12	M42X2	44,5	125,0	41,0	50,0
1212701	R1A245952Y-2448	1"1/2	2-12	M48X2.0	49,0	139,0	48,0	55,0

// R1A245T52Q

Branch Tee adjustable elbow connector
ORFS Male - Metric Male with O-Ring and retaining ring

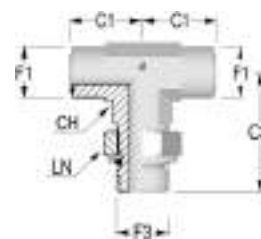

Item Code	Product Code	OD1	F1	F3	C1 (mm)	C3 (mm)	CH (mm)	LN (mm)
1210784	R1A245T52Q-0412	1/4"	9/16-18	M12X1.5	21,5	33,0	14,0	17,0
1210785	R1A245T52Q-0616	3/8"	11/16-16	M16X1.5	25,0	37,5	17,0	22,0
1210786	R1A245T52Q-0818	1/2"	13/16-16	M18X1.5	28,0	41,0	19,0	24,0
1210787	R1A245T52Q-1022	5/8"	1-14	M22X1.5	33,5	49,0	27,0	27,0
1210788	R1A245T52Q-1227	3/4"	1 3/16-12	M27X2	37,5	55,5	27,0	32,0
1211524	R1A245T52Q-1633	1"	1 7/16-12	M33X2.0	41,5	59,5	36,0	41,0
1211525	R1A245T52Q-2042	1"1/4	1 11/16-12	M42X2	44,5	63,0	41,0	36,0
1211526	R1A245T52Q-2448	1"1/2	2-12	M48X2.0	49,0	71,5	48,0	55,0

// R1A245L52Q

Run Tee adjustable elbow connector
ORFS Male - Metric Male with O-Ring and retaining ring

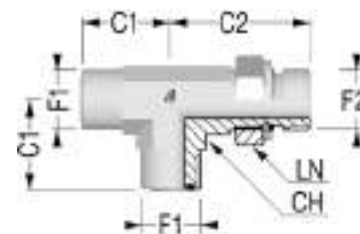

Item Code	Product Code	OD1	F1	F2	C1 (mm)	C2 (mm)	CH (mm)	LN (mm)
1210820	R1A245L52Q-0412	1/4"	9/16-18	M12X1.5	21,5	33,0	14,0	17,0
1210821	R1A245L52Q-0616	3/8"	11/16-16	M16X1.5	25,0	37,5	17,0	22,0
1210822	R1A245L52Q-0818	1/2"	13/16-16	M18X1.5	28,0	41,0	19,0	24,0
1210709	R1A245L52Q-1022	5/8"	1-14	M22X1.5	33,5	49,0	27,0	27,0
1210823	R1A245L52Q-1227	3/4"	1 3/16-12	M27X2	37,5	55,5	27,0	32,0
1211513	R1A245L52Q-1633	1"	1 7/16-12	M33X2.0	41,5	59,5	36,0	41,0
1211514	R1A245L52Q-2042	1"1/4	1 11/16-12	M42X2	44,5	63,0	41,0	50,0
1211515	R1A245L52Q-2448	1"1/2	2-12	M48X2.0	49,0	71,5	48,0	55,0

Design and dimensions shown may be changed without prior notice

// SAE UNF

// R1A2451305

Straight connector

ORFS Male - SAE UNF/UN Male with O-Ring

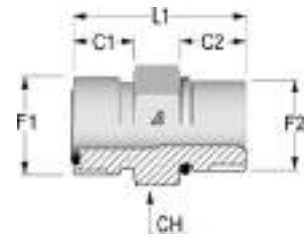

Item Code	Product Code	OD1	F1	F2	C1 (mm)	C2 (mm)	L1 (mm)	CH (mm)
1206963	R1A2451305-0404	1/4"	9/16-18	7/16-20	10,0	11,0	29,0	17,0
1206964	R1A2451305-0406	1/4"	9/16-18	9/16-18	10,0	12,0	30,5	19,0
1212564	R1A2451305-0604	3/8"	11/16-16	7/16-20	11,0	11,0	34,0	19,0
1207972	R1A2451305-0606	3/8"	11/16-16	9/16-18	11,0	12,0	32,0	22,0
1210723	R1A2451305-0608	3/8"	11/16-16	3/4-16	11,0	14,0	35,0	22,0
1208012	R1A2451305-0806	1/2"	13/16-16	9/16-18	13,0	12,0	37,5	22,0
1208013	R1A2451305-0808	1/2"	13/16-16	3/4-16	13,0	14,0	36,5	22,0
1207973	R1A2451305-0810	1/2"	13/16-16	7/8-14	13,0	16,0	40,5	27,0
1212565	R1A2451305-0812	1/2"	13/16-16	1 1/16-12	13,0	18,5	44,5	32,0
1208014	R1A2451305-1008	5/8"	1-14	3/4-16	15,5	14,0	45,0	27,0
1206965	R1A2451305-1010	5/8"	1-14	7/8-14	15,5	16,0	43,0	27,0
1207968	R1A2451305-1012	5/8"	1-14	1 1/16-12	15,5	18,5	47,0	32,0
1212566	R1A2451305-1210	3/4"	1 3/16-12	7/8-14	17,0	16,0	50,5	32,0
1207592	R1A2451305-1212	3/4"	1 3/16-12	1 1/16-12	17,0	18,0	48,5	32,0
1207561	R1A2451305-1216	3/4"	1 3/16-12	1 5/16-12	17,0	18,5	50,0	41,0
1212567	R1A2451305-1220	3/4"	1 3/16-12	1 5/8-12	17,0	18,5	50,5	46,0
1210721	R1A2451305-1612	1"	1 7/16-12	1 1/16-12	17,5	18,5	54,0	41,0
1208015	R1A2451305-1616	1"	1 7/16-12	1 5/16-12	17,5	18,5	50,5	41,0
1210777	R1A2451305-1620	1"	1 7/16-12	1 5/8-12	17,5	18,5	52,0	46,0
1212568	R1A2451305-2016	1"1/4	1 11/16-12	1 5/16-12	17,5	18,5	58,0	46,0
1210778	R1A2451305-2020	1"1/4	1 11/16-12	1 5/8-12	17,5	18,5	52,0	46,0
1211534	R1A2451305-2424	1"1/2	2-12	1 7/8-12	17,5	18,5	54,0	55,0

// R1A245130J

Long connector

ORFS Male - SAE UNF/UN Male with O-Ring

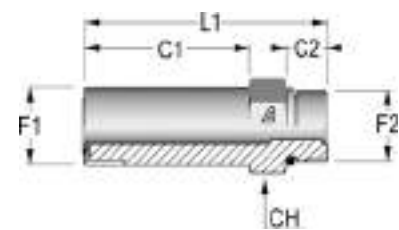

Item Code	Product Code	OD1	F1	F2	C1 (mm)	C2 (mm)	L1 (mm)	CH (mm)
1212556	R1A245130J-0404	1/4"	9/16-18	7/16-20	34,0	9,0	52,5	17,0
1212557	R1A245130J-0606	3/8"	11/16-16	9/16-18	37,0	10,0	58,0	22,0
1212558	R1A245130J-0808	1/2"	13/16-16	3/4-16	44,0	11,0	68,0	22,0
1212559	R1A245130J-1010	5/8"	1-14	7/8-14	52,0	12,5	79,5	27,0
1212560	R1A245130J-1212	3/4"	1 3/16-12	1 1/16-12	64,0	15,0	95,5	32,0
1212561	R1A245130J-1616	1"	1 7/16-12	1 5/16-12	72,5	15,0	105,0	41,0
1212562	R1A245130J-2020	1"1/4	1 11/16-12	1 5/8-12	86,0	15,0	121,0	46,0
1212563	R1A245130J-2424	1"1/2	2-12	1 7/8-12	97,0	15,0	133,5	55,0

// R1A2411305

Straight connector

ORFS Female - SAE UNF/UN Male with O-Ring

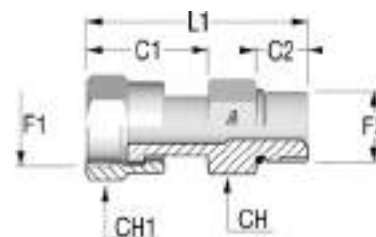

Item Code	Product Code	OD1	F1	F2	C1 (mm)	C2 (mm)	L1 (mm)	CH (mm)	CH1 (mm)
1212508	R1A2411305-0404	1/4"	9/16-18	7/16-20	24,4	11,0	45,2	17,0	19,0
1212509	R1A2411305-0606	3/8"	11/16-16	9/16-18	27,5	12,0	50,0	19,0	22,0
1212510	R1A2411305-0808	1/2"	13/16-16	3/4-16	33,0	14,0	60,0	22,0	24,0
1208302	R1A2411305-1008	5/8"	1-14	3/4-16	37,5	14,0	65,0	24,0	30,0
1212511	R1A2411305-1010	5/8"	1-14	7/8-14	37,5	16,0	66,5	27,0	30,0
1212512	R1A2411305-1212	3/4"	1 3/16-12	1 1/16-12	41,5	18,0	73,5	32,0	36,0
1212513	R1A2411305-1616	1"	1 7/16-12	1 5/16-12	43,8	18,5	82,0	41,0	41,0
1212514	R1A2411305-2020	1"1/4	1 11/16-12	1 5/8-12	43,8	18,5	82,0	50,0	50,0
1212515	R1A2411305-2424	1"1/2	2-12	1 7/8-12	47,5	18,5	81,0	55,0	60,0

// R1A2454305

45° adjustable elbow connector

ORFS Male - SAE UNF/UN Male with O-Ring

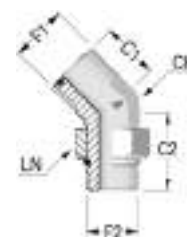

Item Code	Product Code	OD1	F1	F2	C1 (mm)	C2 (mm)	CH (mm)	LN (mm)
1210808	R1A2454305-0404	1/4"	9/16-18	7/16-20	16,0	30,0	14,0	16,0
1210809	R1A2454305-0406	1/4"	9/16-18	9/16-18	17,5	33,0	14,0	19,0
1210810	R1A2454305-0604	3/8"	11/16-16	7/16-20	19,0	31,0	17,0	16,0
1210722	R1A2454305-0606	3/8"	11/16-16	9/16-18	19,0	33,0	17,0	19,0
1207936	R1A2454305-0608	3/8"	11/16-16	3/4-16	19,0	36,5	19,0	24,0
1210811	R1A2454305-0806	1/2"	13/16-16	9/16-18	20,5	32,5	19,0	19,0
1210812	R1A2454305-0808	1/2"	13/16-16	3/4-16	20,5	36,5	19,0	24,0
1210813	R1A2454305-0810	1/2"	13/16-16	7/8-14	21,0	45,0	22,0	27,0
1211543	R1A2454305-1008	5/8"	1-14	3/4-16	23,5	40,5	27,0	24,0
1210814	R1A2454305-1010	5/8"	1-14	7/8-14	23,5	45,0	27,0	27,0
1210815	R1A2454305-1012	5/8"	1-14	1 1/16-12	24,5	50,0	27,0	32,0
1210816	R1A2454305-1210	3/4"	1 3/16-12	7/8-14	26,0	46,0	30,0	27,0
1207975	R1A2454305-1212	3/4"	1 3/16-12	1 1/16-12	26,0	44,0	27,0	32,0
1211544	R1A2454305-1216	3/4"	1 3/16-12	1 5/16-12	29,5	52,5	36,0	41,0
1207974	R1A2454305-1612	1"	1 7/16-12	1 1/16-12	30,0	51,5	33,0	32,0
1210817	R1A2454305-1616	1"	1 7/16-12	1 5/16-12	30,0	52,5	36,0	41,0
1211545	R1A2454305-1620	1"	1 7/16-12	1 5/8-12	32,0	53,5	41,0	50,0
1211546	R1A2454305-2020	1"1/4	1 11/16-12	1 5/8-12	32,0	48,5	41,0	50,0
1211547	R1A2454305-2424	1"1/2	2-12	1 7/8-12	33,5	48,5	48,0	55,0

Design and dimensions shown may be changed without prior notice

// R1A2459305

90° adjustable elbow connector

ORFS Male - SAE UNF/UN Male with O-Ring

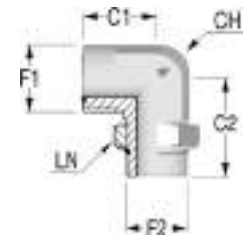

Item Code	Product Code	OD1	F1	F2	C1 (mm)	C2 (mm)	CH (mm)	LN (mm)
1207980	R1A2459305-0404	1/4"	9/16-18	7/16-20	22,5	32,5	14,0	16,0
1207976	R1A2459305-0406	1/4"	9/16-18	9/16-18	23,5	37,0	14,0	19,0
1208016	R1A2459305-0604	3/8"	11/16-16	7/16-20	25,0	35,0	17,0	17,0
1207497	R1A2459305-0606	3/8"	11/16-16	9/16-18	25,0	37,0	17,0	19,0
1210724	R1A2459305-0608	3/8"	11/16-16	3/4-16	26,5	40,5	19,0	24,0
1210725	R1A2459305-0806	1/2"	13/16-16	9/16-18	28,0	36,5	19,0	19,0
1207596	R1A2459305-0808	1/2"	13/16-16	3/4-16	28,0	40,5	19,0	24,0
1207970	R1A2459305-0810	1/2"	13/16-16	7/8-14	31,0	50,0	22,0	27,0
1210726	R1A2459305-1008	5/8"	1-14	3/4-16	33,5	46,0	27,0	24,0
1207971	R1A2459305-1010	5/8"	1-14	7/8-14	33,5	50,0	27,0	27,0
1207969	R1A2459305-1012	5/8"	1-14	1 1/16-12	36,0	55,0	27,0	32,0
1210756	R1A2459305-1210	3/4"	1 3/16-12	7/8-14	37,5	51,0	30,0	27,0
1207977	R1A2459305-1212	3/4"	1 3/16-12	1 1/16-12	37,5	55,0	30,0	32,0
1210711	R1A2459305-1216	3/4"	1 3/16-12	1 5/16-12	41,5	60,0	36,0	41,0
1207978	R1A2459305-1612	1"	1 7/16-12	1 1/16-12	42,0	59,0	33,0	32,0
1210757	R1A2459305-1616	1"	1 7/16-12	1 5/16-12	42,0	60,0	36,0	41,0
1211561	R1A2459305-1620	1"	1 7/16-12	1 5/8-12	45,0	62,0	41,0	50,0
1211562	R1A2459305-2016	1" 1/4	1 11/16-12	1 5/16-12	45,0	62,0	41,0	41,0
1211563	R1A2459305-2020	1" 1/4	1 11/16-12	1 5/8-12	44,5	62,0	41,0	50,0
1211564	R1A2459305-2024	1" 1/4	1 11/16-12	1 7/8-12	49,0	66,0	48,0	55,0
1211565	R1A2459305-2424	1" 1/2	2-12	1 7/8-12	49,0	66,0	48,0	55,0

// R1A245930J

90° adjustable long elbow connector

ORFS Male - SAE UNF/UN Male with O-Ring

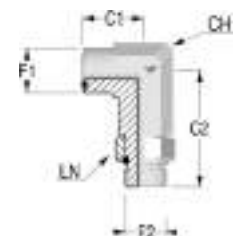

Item Code	Product Code	OD1	F1	F2	C1 (mm)	C2 (mm)	CH (mm)	LN (mm)
1212635	R1A245930J-0404	1/4"	9/16-18	7/16-20	21,5	56,5	14,0	16,0
1212636	R1A245930J-0406	1/4"	9/16-18	9/16-18	23,5	66,0	14,0	19,0
1212637	R1A245930J-0606	3/8"	11/16-16	9/16-18	25,0	66,0	17,0	19,0
1212638	R1A245930J-0608	3/8"	11/16-16	3/4-16	26,5	75,0	19,0	24,0
1212639	R1A245930J-0808	1/2"	13/16-16	3/4-16	28,0	75,0	19,0	24,0
1212640	R1A245930J-0810	1/2"	13/16-16	7/8-14	31,0	89,0	22,0	27,0
1212641	R1A245930J-1010	5/8"	1-14	7/8-14	33,5	89,0	27,0	27,0
1212642	R1A245930J-1012	5/8"	1-14	1 1/16-12	36,0	101,0	27,0	32,0
1212643	R1A245930J-1212	3/4"	1 3/16-12	1 1/16-12	37,5	101,0	30,0	32,0
1212644	R1A245930J-1216	3/4"	1 3/16-12	1 5/16-12	41,5	114,0	36,0	41,0
1212645	R1A245930J-1616	1"	1 7/16-12	1 5/16-12	42,0	114,0	36,0	41,0
1212646	R1A245930J-1620	1"	1 7/16-12	1 5/8-12	45,0	126,0	41,0	50,0
1212647	R1A245930J-2020	1" 1/4	1 11/16-12	1 5/8-12	45,0	126,0	41,0	50,0
1212648	R1A245930J-2024	1" 1/4	1 11/16-12	1 7/8-12	49,0	139,0	48,0	55,0
1212649	R1A245930J-2424	1" 1/2	2-12	1 7/8-12	49,0	139,0	48,0	55,0

// R1A245T305

Branch Tee adjustable elbow connector
ORFS Male - SAE UNF/UN Male with O-Ring

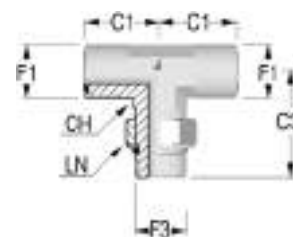

Item Code	Product Code	OD1	F1	F3	C1 (mm)	C3 (mm)	CH (mm)	LN (mm)
1210720	R1A245T305-0404	1/4"	9/16-18	7/16-20	21,5	32,5	14,0	16,0
1210780	R1A245T305-0606	3/8"	11/16-16	9/16-18	25,0	37,0	17,0	19,0
1210781	R1A245T305-0808	1/2"	13/16-16	3/4-16	28,0	40,5	19,0	24,0
1210782	R1A245T305-1010	5/8"	1-14	7/8-14	33,5	50,0	27,0	27,0
1210783	R1A245T305-1212	3/4"	1 3/16-12	1 1/16-12	37,5	55,0	30,0	32,0
1211521	R1A245T305-1616	1"	1 7/16-12	1 5/16-12	42,0	60,0	36,0	41,0
1211522	R1A245T305-2020	1"1/4	1 11/16-12	1 5/8-12	45,0	62,0	41,0	50,0
1211523	R1A245T305-2424	1"1/2	2-12	1 7/8-12	49,0	66,0	48,0	55,0

// R1A245L305

Run Tee adjustable elbow connector
ORFS Male - SAE UNF/UN Male with O-Ring

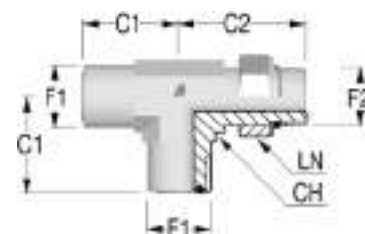

Item Code	Product Code	OD1	F1	F2	C1 (mm)	C2 (mm)	CH (mm)	LN (mm)
1210798	R1A245L305-0404	1/4"	9/16-18	7/16-20	21,5	32,5	14,0	16,0
1210799	R1A245L305-0606	3/8"	11/16-16	9/16-18	25,0	37,0	17,0	19,0
1210818	R1A245L305-0808	1/2"	13/16-16	3/4-16	28,0	40,5	19,0	24,0
1210819	R1A245L305-1010	5/8"	1-14	7/8-14	33,5	50,0	27,0	27,0
1211509	R1A245L305-1212	3/4"	1 3/16-12	1 1/16-12	37,5	55,0	30,0	32,0
1211510	R1A245L305-1616	1"	1 7/16-12	1 5/16-12	42,0	60,0	36,0	41,0
1211511	R1A245L305-2020	1"1/4	1 11/16-12	1 5/8-12	45,0	62,0	41,0	50,0
1211512	R1A245L305-2424	1"1/2	2-12	1 7/8-12	49,0	66,0	48,0	55,0

Design and dimensions shown may be changed without prior notice

// FLANGES

// R1A245133W

Straight flange SAE J518 code 61

ORFS Male - Low pressure

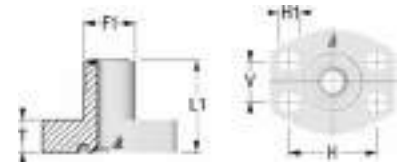

Item Code	Product Code	OD1	F1	F2	T (mm)	H1 (mm)	H (mm)	V (mm)	L1 (mm)
1212569	R1A245133W-0608	3/8"	11/16-16	1/2	14,0	9,0	38,1	17,5	37,0
1212570	R1A245133W-0808	1/2"	13/16-16	1/2	14,0	9,0	38,1	17,5	39,0
1212571	R1A245133W-1008	5/8"	1-14	1/2	14,0	9,0	38,1	17,5	40,0
1212572	R1A245133W-1012	5/8"	1-14	3/4	15,0	11,0	47,6	22,2	44,0
1212573	R1A245133W-1212	3/4"	1 3/16-12	3/4	15,0	11,0	47,6	22,2	45,0
1212574	R1A245133W-1216	3/4"	1 3/16-12	1	17,0	11,0	52,4	26,2	48,0
1212575	R1A245133W-1616	1"	1 7/16-12	1	17,0	11,0	52,4	26,2	49,0
1212576	R1A245133W-1620	1"	1 7/16-12	1 1/4	21,0	11,5	58,7	30,2	55,0
1212577	R1A245133W-2020	1 1/4"	1 11/16-12	1 1/4	21,0	11,5	58,7	30,2	55,0
1212578	R1A245133W-2024	1 1/4"	1 11/16-12	1 1/2	24,0	13,5	69,9	35,7	59,0
1212579	R1A245133W-2424	1 1/2"	2-12	1 1/2	24,0	13,5	69,9	35,7	61,0

// R1A245136W

Straight flange SAE J518 code 62

ORFS Male - High pressure

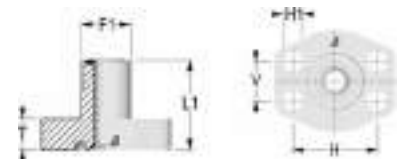

Item Code	Product Code	OD1	F1	F2	T (mm)	H1 (mm)	H (mm)	V (mm)	L1 (mm)
1212580	R1A245136W-0608	3/8"	11/16-16	1/2	15,0	9,0	40,5	18,2	37,0
1212581	R1A245136W-0808	1/2"	13/16-16	1/2	15,0	9,0	40,5	18,2	39,0
1212582	R1A245136W-1008	5/8"	1-14	1/2	15,0	9,0	40,5	18,2	40,0
1212583	R1A245136W-1012	5/8"	1-14	3/4	17,0	11,0	50,8	23,8	44,0
1212584	R1A245136W-1212	3/4"	1 3/16-12	3/4	17,0	11,0	50,8	23,8	45,0
1212585	R1A245136W-1216	3/4"	1 3/16-12	1	21,0	13,0	57,2	27,8	48,0
1212586	R1A245136W-1616	1"	1 7/16-12	1	21,0	13,0	57,2	27,8	49,0
1212587	R1A245136W-1620	1"	1 7/16-12	1 1/4	24,0	15,0	66,7	31,8	55,0
1212588	R1A245136W-2020	1 1/4"	1 11/16-12	1 1/4	24,0	15,0	66,7	31,8	55,0
1212589	R1A245136W-2024	1 1/4"	1 11/16-12	1 1/2	27,0	17,0	79,4	36,5	59,0
1212590	R1A245136W-2424	1 1/2"	2-12	1 1/2	27,0	17,0	79,4	36,5	61,0

// R1A245933W

90° flange SAE J518 code 61

ORFS Male - Low pressure

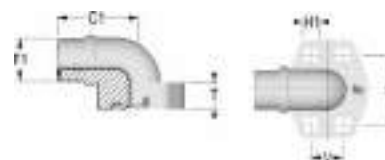

Item Code	Product Code	OD1	F1	F2	C1 (mm)	T (mm)	H1 (mm)	H (mm)	V (mm)
1212650	R1A245933W-0608	3/8"	11/16-16	1/2	37,0	17,0	9,0	38,1	17,5
1212651	R1A245933W-0808	1/2"	13/16-16	1/2	39,0	17,0	9,0	38,1	17,5
1212652	R1A245933W-1008	5/8"	1-14	1/2	40,0	20,0	9,0	38,1	17,5
1212653	R1A245933W-1012	5/8"	1-14	3/4	44,0	20,0	11,0	47,6	22,2
1212654	R1A245933W-1212	3/4"	1 3/16-12	3/4	45,0	25,0	11,0	47,6	22,2
1212655	R1A245933W-1216	3/4"	1 3/16-12	1	48,0	25,0	11,0	52,4	26,2
1212656	R1A245933W-1616	1"	1 7/16-12	1	49,0	31,0	11,0	52,4	26,2
1212657	R1A245933W-1620	1"	1 7/16-12	1 1/4	55,0	31,0	11,5	58,7	30,2
1212658	R1A245933W-2020	1"1/4	1 11/16-12	1 1/4	55,0	31,0	11,5	58,7	30,2
1212659	R1A245933W-2024	1"1/4	1 11/16-12	1 1/2	59,0	31,0	13,5	69,9	35,7
1212660	R1A245933W-2424	1"1/2	2-12	1 1/2	61,0	37,0	13,5	69,9	35,7

// R1A245936W

90° flange SAE J518 code 62

ORFS Male - High pressure

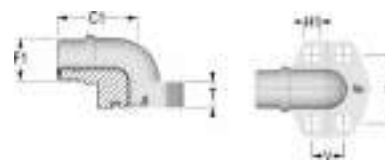

Item Code	Product Code	OD1	F1	F2	C1 (mm)	T (mm)	H1 (mm)	H (mm)	V (mm)
1212670	R1A245936W-0608	3/8"	11/16-16	1/2	37,0	17,0	9,0	40,5	18,2
1212671	R1A245936W-0808	1/2"	13/16-16	1/2	39,0	17,0	9,0	40,5	18,2
1212672	R1A245936W-1008	5/8"	1-14	1/2	40,0	20,0	9,0	40,5	18,2
1212673	R1A245936W-1012	5/8"	1-14	3/4	44,0	20,0	11,0	50,8	23,8
1212674	R1A245936W-1212	3/4"	1 3/16-12	3/4	45,0	25,0	11,0	50,8	23,8
1212675	R1A245936W-1216	3/4"	1 3/16-12	1	48,0	25,0	13,0	57,2	27,8
1212676	R1A245936W-1616	1"	1 7/16-12	1	49,0	31,0	13,0	57,2	27,8
1212677	R1A245936W-1620	1"	1 7/16-12	1 1/4	55,0	31,0	15,0	66,7	31,8
1212678	R1A245936W-2020	1"1/4	1 11/16-12	1 1/4	55,0	31,0	15,0	66,7	31,8
1212679	R1A245936W-2024	1"1/4	1 11/16-12	1 1/2	59,0	37,0	17,0	79,4	36,5
1212680	R1A245936W-2424	1"1/2	2-12	1 1/2	61,0	37,0	17,0	79,4	36,5

Design and dimensions shown may be changed without prior notice

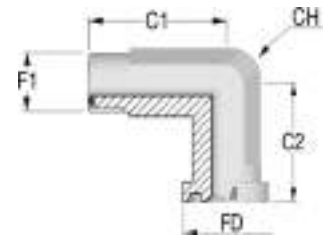
// R1A2459334**90° adjustable flange SAE J518 code 61****ORFS Male - Low pressure**

Item Code	Product Code	OD1	F1	F2	FD (mm)	C1 (mm)	C2 (mm)	CH (mm)
1212662	R1A2459334-0808	1/2"	13/16-16	1/2	30,2	48,0	42,0	22,0
1212663	R1A2459334-1008	5/8"	1-14	1/2	30,2	50,0	44,0	22,0
1212664	R1A2459334-1212	3/4"	1 3/16-12	3/4	38,1	64,0	53,0	27,0
1212665	R1A2459334-1616	1"	1 7/16-12	1	44,4	65,0	60,0	34,0
1212666	R1A2459334-1620	1"	1 7/16-12	1 1/4	50,8	64,0	55,0	42,0
1212667	R1A2459334-2020	1"1/4	1 11/16-12	1 1/4	50,8	64,0	55,0	42,0
1212668	R1A2459334-2024	1"1/4	1 11/16-12	1 1/2	60,3	78,0	66,0	50,0
1212669	R1A2459334-2424	1"1/2	2-12	1 1/2	60,3	78,0	66,0	50,0

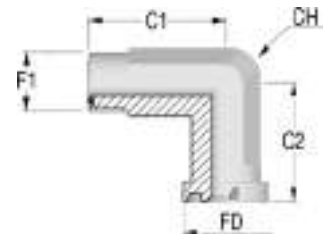
// R1A2459364**90° adjustable flange SAE J518 code 62****ORFS Male - High pressure**

Item Code	Product Code	OD1	F1	F2	FD (mm)	C1 (mm)	C2 (mm)	CH (mm)
1212681	R1A2459364-0608	3/8"	11/16-16	1/2	31,8	50,0	44,0	22,0
1212682	R1A2459364-0808	1/2"	13/16-16	1/2	31,8	43,0	49,0	22,0
1212683	R1A2459364-1008	5/8"	1-14	1/2	31,8	50,0	44,0	22,0
1212684	R1A2459364-1012	5/8"	1-14	3/4	41,3	64,0	53,0	27,0
1212685	R1A2459364-1212	3/4"	1 3/16-12	3/4	41,3	64,0	53,0	27,0
1212686	R1A2459364-1216	3/4"	1 3/16-12	1	47,6	62,0	60,0	34,0
1212687	R1A2459364-1616	1"	1 7/16-12	1	47,6	62,0	60,0	34,0
1212688	R1A2459364-1620	1"	1 7/16-12	1 1/4	54,0	72,0	70,0	42,0
1212689	R1A2459364-2020	1"1/4	1 11/16-12	1 1/4	54,0	72,0	70,0	42,0
1212690	R1A2459364-2024	1"1/4	1 11/16-12	1 1/2	63,5	84,0	80,0	50,0
1212691	R1A2459364-2424	1"1/2	2-12	1 1/2	63,5	84,0	80,0	50,0

// ACCESSORIES

// HX0D2403

Nut ORFS

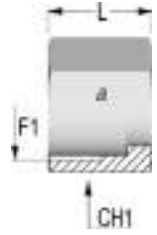

Item Code	Product Code	OD1	F1	L (mm)	CH1 (mm)
1223385	HX0D2403-040000	6	9/16-18	14,5	17,0
1221423	HX0D2403-060000	8	11/16-16	17,0	22,0
1209980	HX0D2403-080000	12	13/16-16	21,0	24,0
1209992	HX0D2403-100000	14	1-14	23,5	30,0
1210042	HX0D2403-120000	18	1 3/16-12	26,0	36,0
1217528	HX0D2403-160000	22	1 7/16-12	28,0	41,0
1217529	HX0D2403-200000	28	1 11/16-12	28,0	50,0
1217530	HX0D2403-240000	35	2-12	28,0	57,0

Design and dimensions shown may be changed without prior notice

// PLUG

// R1A2431000

Cap ORFS Female

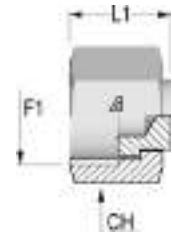

Item Code	Product Code	OD1	F1	L1 (mm)	CH (mm)
1207932	R1A2431000-0400	1/4"	9/16-18	17,0	17,0
1207711	R1A2431000-0600	3/8"	11/16-16	20,0	22,0
1207933	R1A2431000-0800	1/2"	13/16-16	23,0	24,0
1208261	R1A2431000-1000	5/8"	1-14	27,0	30,0
1208260	R1A2431000-1200	3/4"	1 3/16-12	30,0	36,0
1208259	R1A2431000-1600	1"	1 7/16-12	31,0	41,0
1208258	R1A2431000-2000	1 1/4"	1 11/16-12	31,0	50,0
1210844	R1A2431000-2400	1 1/2"	2-12	31,0	57,0

// R1A2451000

Plug ORFS Male

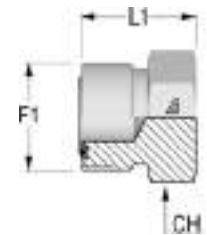

Item Code	Product Code	OD1	F1	L1 (mm)	CH (mm)
1207934	R1A2451000-0400	1/4"	9/16-18	16,5	17,0
1207772	R1A2451000-0600	3/8"	11/16-16	19,0	19,0
1207935	R1A2451000-0800	1/2"	13/16-16	22,0	22,0
1208215	R1A2451000-1000	5/8"	1-14	26,0	27,0
1208216	R1A2451000-1200	3/4"	1 3/16-12	27,5	32,0
1208217	R1A2451000-1600	1"	1 7/16-12	28,0	41,0
1208218	R1A2451000-2000	1 1/4"	1 11/16-12	28,0	46,0
1210824	R1A2451000-2400	1 1/2"	2-12	28,0	55,0



// BSP ADAPTERS

// MALE UNION.....	281	// BSPP.....	290
// MALE/FEMALE UNION.....	284	// FLANGES.....	293
// FEMALE UNION.....	287	// PLUG.....	296
// BULKHEAD.....	288		

Design and dimensions shown may be changed without prior notice

// MALE UNION

// R1A05M105M

Straight union BSP 60° Male

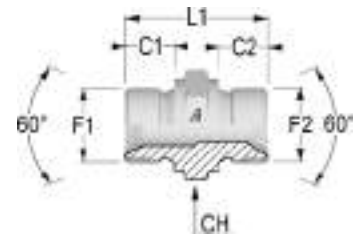

Item Code	Product Code	OD1	F1	F2	C1 (mm)	C2 (mm)	L1 (mm)	CH (mm)
1203778	R1A05M105M-0202	1/8"	1/8-28	1/8-28	8,0	8,0	25,0	14,0
1207670	R1A05M105M-0204	1/8"	1/8-28	1/4-19	8,0	11,0	27,5	19,0
1212029	R1A05M105M-0206	1/8"	1/8-28	3/8-19	8,0	12,0	30,0	22,0
1212030	R1A05M105M-0208	1/8"	1/8-28	1/2-14	8,0	14,0	33,0	27,0
1203775	R1A05M105M-0404	1/4"	1/4-19	1/4-19	11,0	11,0	31,0	19,0
1207671	R1A05M105M-0406	1/4"	1/4-19	3/8-19	11,0	12,0	33,5	22,0
1249471	R1A05M105M-0408	1/4"	1/4-19	1/2-14	11,0	14,0	36,0	27,0
1208335	R1A05M105M-0412	1/4"	1/4-19	3/4-14	11,0	16,0	39,5	32,0
1203798	R1A05M105M-0606	3/8"	3/8-19	3/8-19	12,0	12,0	35,0	22,0
1249468	R1A05M105M-0608	3/8"	3/8-19	1/2-14	12,0	14,0	37,5	27,0
1212031	R1A05M105M-0610	3/8"	3/8-19	5/8-14	12,0	16,0	40,5	30,0
1207701	R1A05M105M-0612	3/8"	3/8-19	3/4-14	12,0	16,0	41,0	32,0
1212032	R1A05M105M-0616	3/8"	3/8-19	1-11	12,0	18,0	46,0	41,0
1249469	R1A05M105M-0808	1/2"	1/2-14	1/2-14	14,0	14,0	40,0	27,0
1212033	R1A05M105M-0810	1/2"	1/2-14	5/8-14	14,0	16,0	43,0	30,0
1249472	R1A05M105M-0812	1/2"	1/2-14	3/4-14	14,0	16,0	43,5	32,0
1212034	R1A05M105M-0816	1/2"	1/2-14	1-11	14,0	18,0	48,0	41,0
1212035	R1A05M105M-0820	1/2"	1/2-14	1 1/4-11	14,0	20,0	52,0	50,0
1212036	R1A05M105M-0824	1/2"	1/2-14	1 1/2-11	14,0	22,0	56,0	55,0
1203803	R1A05M105M-1010	5/8"	5/8-14	5/8-14	16,0	16,0	45,0	30,0
1208252	R1A05M105M-1012	5/8"	5/8-14	3/4-14	16,0	16,0	45,5	32,0
1205572	R1A05M105M-1016	5/8"	5/8-14	1-11	16,0	18,0	50,0	41,0
1212037	R1A05M105M-1020	5/8"	5/8-14	1 1/4-11	16,0	20,0	54,0	50,0
1249470	R1A05M105M-1212	3/4"	3/4-14	3/4-14	16,0	16,0	45,5	32,0
1207675	R1A05M105M-1216	3/4"	3/4-14	1-11	16,0	18,0	50,0	41,0
1208293	R1A05M105M-1220	3/4"	3/4-14	1 1/4-11	16,0	20,0	54,0	50,0
1212038	R1A05M105M-1224	3/4"	3/4-14	1 1/2-11	16,0	22,0	58,0	55,0
1203747	R1A05M105M-1616	1"	1-11	1-11	18,0	18,0	52,0	41,0
1207676	R1A05M105M-1620	1"	1-11	1 1/4-11	18,0	20,0	56,0	50,0
1207677	R1A05M105M-1624	1"	1-11	1 1/2-11	18,0	22,0	60,0	55,0
1203757	R1A05M105M-2020	1"1/4	1 1/4-11	1 1/4-11	20,0	20,0	58,0	50,0
1208195	R1A05M105M-2024	1"1/4	1 1/4-11	1 1/2-11	20,0	22,0	62,0	55,0
1212040	R1A05M105M-2032	1"1/4	1 1/4-11	2-11	20,0	24,0	64,5	70,0
1203751	R1A05M105M-2424	1"1/2	1 1/2-11	1 1/2-11	22,0	22,0	64,0	55,0
1205940	R1A05M105M-2432	1"1/2	1 1/2-11	2-11	22,0	24,0	66,5	70,0
1203780	R1A05M105M-3232	2"	2-11	2-11	24,0	24,0	69,0	70,0

// R1A05M905M

90° union BSP 60° Male

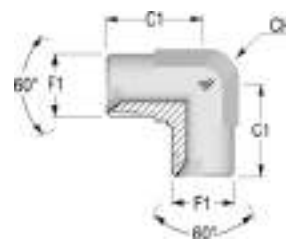

Item Code	Product Code	OD1	F1	C1 (mm)	CH (mm)
1207905	R1A05M905M-0202	1/8"	1/8-28	20,0	12,0
1207505	R1A05M905M-0404	1/4"	1/4-19	26,0	14,0
1206438	R1A05M905M-0606	3/8"	3/8-19	30,0	17,0
1207542	R1A05M905M-0808	1/2"	1/2-14	35,0	22,0
1212187	R1A05M905M-1010	5/8"	5/8-14	38,0	22,0
1203905	R1A05M905M-1212	3/4"	3/4-14	42,0	27,0
1208198	R1A05M905M-1616	1"	1-11	47,0	33,0
1208199	R1A05M905M-2020	1"1/4	1 1/4-11	52,0	41,0
1210968	R1A05M905M-2424	1"1/2	1 1/2-11	60,0	48,0

// R1A05MT05M

Branch Tee union BSP 60° Male

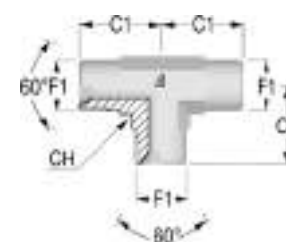

Item Code	Product Code	OD1	F1	C1 (mm)	CH (mm)
1211959	R1A05MT05M-0202	1/8"	1/8-28	20,0	12,0
1203955	R1A05MT05M-0404	1/4"	1/4-19	26,0	14,0
1203956	R1A05MT05M-0606	3/8"	3/8-19	30,0	17,0
1206940	R1A05MT05M-0808	1/2"	1/2-14	35,0	22,0
1211960	R1A05MT05M-1010	5/8"	5/8-14	38,0	22,0
1207236	R1A05MT05M-1212	3/4"	3/4-14	42,0	27,0
1206450	R1A05MT05M-1616	1"	1-11	47,0	33,0
1208144	R1A05MT05M-2020	1"1/4	1 1/4-11	52,0	41,0
1208145	R1A05MT05M-2424	1"1/2	1 1/2-11	60,0	48,0

Design and dimensions shown may be changed without prior notice

// R1A05MX05M

Cross union BSP 60° Male

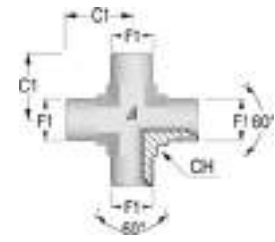

Item Code	Product Code	OD1	F1	C1 (mm)	CH (mm)
1212021	R1A05MX05M-0202	1/8"	1/8-28	20,0	12,0
1212022	R1A05MX05M-0404	1/4"	1/4-19	26,0	14,0
1212023	R1A05MX05M-0606	3/8"	3/8-19	30,0	17,0
1206941	R1A05MX05M-0808	1/2"	1/2-14	35,0	22,0
1212024	R1A05MX05M-1010	5/8"	5/8-14	38,0	22,0
1212025	R1A05MX05M-1212	3/4"	3/4-14	42,0	27,0
1212026	R1A05MX05M-1616	1"	1-11	47,0	33,0
1212027	R1A05MX05M-2020	1"1/4	1 1/4-11	52,0	41,0
1212028	R1A05MX05M-2424	1"1/2	1 1/2-11	60,0	48,0

// MALE/FEMALE UNION

// R1A05M1051

Straight union BSP 60° Male - Female

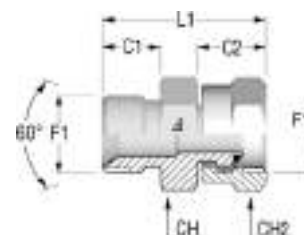

Item Code	Product Code	OD1	F1	F2	C1 (mm)	C2 (mm)	L1 (mm)	CH (mm)	CH2 (mm)
1216217	R1A05M1051-0202	1/8"	1/8-28	1/8-28	9,5	13,0	29,0	14,0	14,0
1207697	R1A05M1051-0404	1/4"	1/4-19	1/4-19	13,0	15,5	33,5	19,0	19,0
1207698	R1A05M1051-0606	3/8"	3/8-19	3/8-19	14,5	17,7	38,7	22,0	22,0
1207699	R1A05M1051-0808	1/2"	1/2-14	1/2-14	17,0	19,0	43,0	27,0	27,0
1207700	R1A05M1051-1212	3/4"	3/4-14	3/4-14	19,0	22,0	50,0	32,0	32,0
1207686	R1A05M1051-1616	1"	1-11	1-11	21,0	25,5	59,5	41,0	38,0
1207783	R1A05M1052-2020	1"1/4	1 1/4-11	1 1/4-11	20,0	31,1	69,1	50,0	50,0
1207784	R1A05M1052-2424	1"1/2	1 1/2-11	1 1/2-11	22,0	35,0	75,0	55,0	55,0

// R1A05M4051

45° union BSP 60° Male - Female

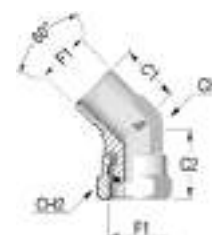

Item Code	Product Code	OD1	F1	C1 (mm)	C2 (mm)	CH (mm)	CH2 (mm)
1212126	R1A05M4051-0202	1/8"	1/8-28	16,0	20,5	12,0	14,0
1212145	R1A05M4051-0404	1/4"	1/4-19	21,0	25,5	14,0	19,0
1212146	R1A05M4051-0606	3/8"	3/8-19	24,0	31,2	17,0	22,0
1207907	R1A05M4051-0808	1/2"	1/2-14	27,0	35,5	22,0	27,0
1207786	R1A05M4051-1212	3/4"	3/4-14	32,0	39,0	27,0	32,0
1210963	R1A05M4051-1616	1"	1-11	35,0	42,5	33,0	38,0
1212148	R1A05M4052-2020	1"1/4	1 1/4-11	37,0	44,1	41,0	50,0
1212149	R1A05M4082-2424	1"1/2	1 1/2-11	46,0	59,2	48,0	55,0

Design and dimensions shown may be changed without prior notice

// R1A05M9051

90° union BSP 60° Male - Female

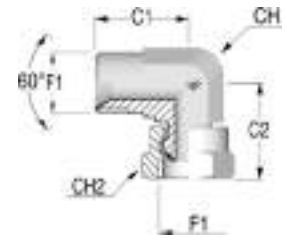

Item Code	Product Code	OD1	F1	C1 (mm)	C2 (mm)	CH (mm)	CH2 (mm)
1218490	R1A05M9051-0202	1/8"	1/8-28	22,0	26,5	12,0	14,0
1207702	R1A05M9051-0404	1/4"	1/4-19	26,0	30,5	14,0	19,0
1207703	R1A05M9051-0606	3/8"	3/8-19	30,0	36,2	17,0	22,0
1207704	R1A05M9051-0808	1/2"	1/2-14	35,0	41,5	22,0	27,0
1212219	R1A05M9051-1010	5/8"	5/8-14	38,0	47,7	22,0	27,0
1207946	R1A05M9051-1212	3/4"	3/4-14	42,0	51,0	27,0	32,0
1207947	R1A05M9051-1616	1"	1-11	47,0	54,5	33,0	38,0
1207948	R1A05M9052-2020	1*1/4	1 1/4-11	52,0	59,1	41,0	50,0
1208137	R1A05M9052-2424	1*1/2	1 1/2-11	60,0	73,2	48,0	55,0

// R1A05MT051

Branch Tee union BSP 60° Male - Female

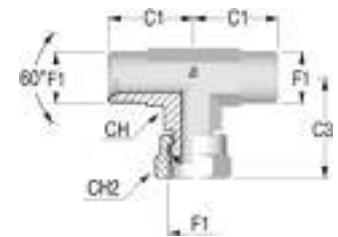

Item Code	Product Code	OD1	F1	C1 (mm)	C3 (mm)	CH (mm)	CH2 (mm)
1211970	R1A05MT051-0202	1/8"	1/8-28	22,0	27,0	12,0	14,0
1207705	R1A05MT051-0404	1/4"	1/4-19	26,0	30,5	14,0	19,0
1207706	R1A05MT051-0606	3/8"	3/8-19	30,0	36,2	17,0	22,0
1207707	R1A05MT051-0808	1/2"	1/2-14	35,0	41,5	22,0	27,0
1207708	R1A05MT051-1212	3/4"	3/4-14	42,0	51,0	27,0	32,0
1207709	R1A05MT051-1616	1"	1-11	47,0	54,5	33,0	38,0
1211983	R1A05MT052-2424	1*1/2	1 1/2-11	60,0	73,2	48,0	55,0
1211982	R1A05MT082-1010	5/8"	5/8-14	38,0	47,7	22,0	27,0
1210950	R1A05MT082-2020	1*1/4	1 1/4-11	52,0	59,1	41,0	50,0

// R1A05ML051

Run Tee union BSP 60° Male - Female

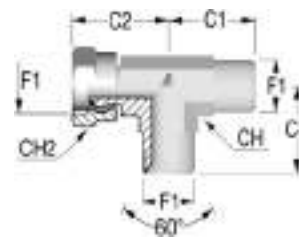

Item Code	Product Code	OD1	F1	C1 (mm)	C2 (mm)	CH (mm)	CH2 (mm)
1211908	R1A05ML051-0202	1/8"	1/8-28	22,0	26,5	12,0	14,0
1207787	R1A05ML051-0404	1/4"	1/4-19	26,0	30,5	14,0	19,0
1207788	R1A05ML051-0606	3/8"	3/8-19	30,0	36,2	17,0	22,0
1207789	R1A05ML051-0808	1/2"	1/2-14	35,0	41,5	22,0	27,0
1207790	R1A05ML051-1212	3/4"	3/4-14	42,0	51,0	27,0	32,0
1207791	R1A05ML051-1616	1"	1-11	47,0	54,5	33,0	38,0
1210946	R1A05ML052-2020	1"1/4	1 1/4-11	52,0	59,1	41,0	50,0
1211921	R1A05ML052-2424	1"1/2	1 1/2-11	60,0	73,2	48,0	55,0

Design and dimensions shown may be changed without prior notice

// FEMALE UNION

// R1A0511051

Straight union BSP 60° Female

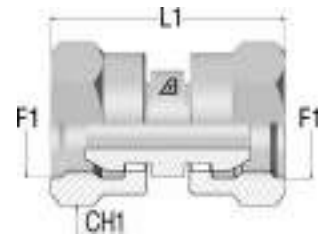

Item Code	Product Code	OD1	F1	F2	L1 (mm)	CH1 (mm)
1205935	R1A0511051-0404	1/4"	1/4-19	1/4-19	36,0	19,0
1205934	R1A0511051-0606	3/8"	3/8-19	3/8-19	38,9	22,0
1205936	R1A0511051-0808	1/2"	1/2-14	1/2-14	44,5	27,0
1207901	R1A0511051-1212	3/4"	3/4-14	3/4-14	49,5	32,0
1203738	R1A0511051-1616	1"	1-11	1-11	56,0	38,0

// R1A0519051

90° union BSP 60° Female

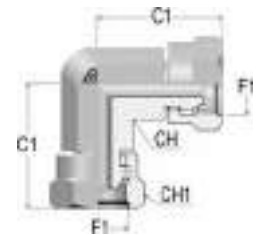

Item Code	Product Code	OD1	F1	C1 (mm)	CH (mm)	CH1 (mm)
1224079	R1A0519051-0404	1/4"	1/4-19	30,5	14,0	19,0
1224080	R1A0519051-0606	3/8"	3/8-19	36,2	17,0	22,0
1208320	R1A0519051-0808	1/2"	1/2-14	41,5	22,0	27,0
1224081	R1A0519051-1212	3/4"	3/4-14	51,0	27,0	32,0
1224082	R1A0519051-1616	1"	1-11	54,5	33,0	38,0

// R1A051T051

Branch Tee union BSP 60° Female

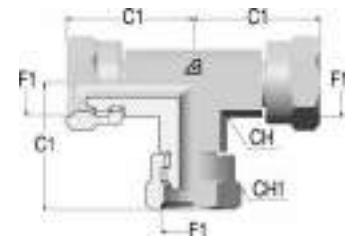

Item Code	Product Code	OD1	F1	C1 (mm)	CH (mm)	CH1 (mm)
1218501	R1A051T051-0404	1/4"	1/4-19	30,5	14,0	19,0
1218502	R1A051T051-0606	3/8"	3/8-19	36,2	17,0	22,0
1218503	R1A051T051-0808	1/2"	1/2-14	41,5	22,0	27,0
1206665	R1A051T051-1212	3/4"	3/4-14	51,0	27,0	32,0
1218505	R1A051T051-1616	1"	1-11	54,5	33,0	38,0

// BULKHEAD

// R1A05M105T

Straight union BSP 60° Bulkhead

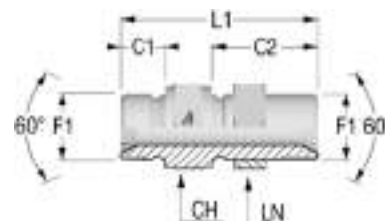

Item Code	Product Code	OD1	F1	C1 (mm)	C2 (mm)	L1 (mm)	CH (mm)	LN (mm)
1212042	R1A05M105T-0202	1/8"	1/8-28	9,5	25,0	40,5	14,0	14,0
1207678	R1A05M105T-0404	1/4"	1/4-19	13,0	29,0	47,0	19,0	19,0
1207679	R1A05M105T-0606	3/8"	3/8-19	14,5	31,0	51,5	22,0	22,0
1207680	R1A05M105T-0808	1/2"	1/2-14	17,0	34,0	58,0	27,0	27,0
1207681	R1A05M105T-1010	5/8"	5/8-14	19,0	37,0	63,0	30,0	32,0
1207682	R1A05M105T-1212	3/4"	3/4-14	19,0	37,0	63,5	32,0	32,0
1207683	R1A05M105T-1616	1"	1-11	21,0	41,0	72,0	41,0	41,0
1207684	R1A05M105T-2020	1 1/4"	1 1/4-11	23,0	45,0	80,0	50,0	50,0
1210955	R1A05M105T-2424	1 1/2"	1 1/2-11	25,0	49,0	88,0	55,0	55,0

// R1A05M905T

90° elbow connector BSP 60° Bulkhead

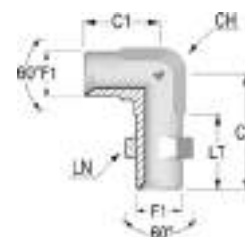

Item Code	Product Code	OD1	F1	C1 (mm)	C2 (mm)	LT (mm)	CH (mm)	LN (mm)
1212188	R1A05M905T-0202	1/8"	1/8-28	20,0	37,0	25,0	12,0	14,0
1210969	R1A05M905T-0404	1/4"	1/4-19	26,0	47,0	29,0	14,0	19,0
1210970	R1A05M905T-0606	3/8"	3/8-19	30,0	49,0	31,0	17,0	22,0
1210971	R1A05M905T-0808	1/2"	1/2-14	35,0	55,0	34,0	22,0	27,0
1212189	R1A05M905T-1010	5/8"	5/8-14	38,0	59,0	37,0	22,0	32,0
1210972	R1A05M905T-1212	3/4"	3/4-14	42,0	63,0	35,0	33,0	41,0
1210973	R1A05M905T-1616	1"	1-11	47,0	69,0	41,0	33,0	41,0
1210974	R1A05M905T-2020	1 1/4"	1 1/4-11	52,0	77,0	45,0	41,0	50,0
1210975	R1A05M905T-2424	1 1/2"	1 1/2-11	60,0	87,0	49,0	48,0	55,0

Design and dimensions shown may be changed without prior notice

// R1A05MT05T

Branch Tee union BSP 60° Bulkhead

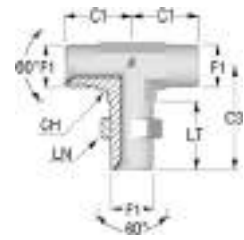

Item Code	Product Code	OD1	F1	C1 (mm)	C3 (mm)	LT (mm)	CH (mm)	LN (mm)
1211961	R1A05MT05T-0202	1/8"	1/8-28	20,0	37,0	25,0	12,0	14,0
1211962	R1A05MT05T-0404	1/4"	1/4-19	26,0	44,0	29,0	14,0	19,0
1211963	R1A05MT05T-0606	3/8"	3/8-19	27,0	49,0	31,0	17,0	22,0
1211964	R1A05MT05T-0808	1/2"	1/2-14	35,0	55,0	34,0	22,0	27,0
1211965	R1A05MT05T-1010	5/8"	5/8-14	38,0	59,0	37,0	22,0	32,0
1211966	R1A05MT05T-1212	3/4"	3/4-14	42,0	63,0	37,0	27,0	36,0
1211967	R1A05MT05T-1616	1"	1-11	47,0	69,0	41,0	33,0	41,0
1211968	R1A05MT05T-2020	1 1/4"	1 1/4-11	52,0	77,0	45,0	41,0	50,0
1211969	R1A05MT05T-2424	1 1/2"	1 1/2-11	60,0	87,0	49,0	48,0	55,0

// R1A05ML05T

Run Tee union BSP 60° Bulkhead

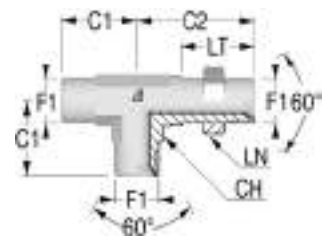

Item Code	Product Code	OD1	F1	C1 (mm)	C2 (mm)	LT (mm)	CH (mm)	LN (mm)
1211899	R1A05ML05T-0202	1/8"	1/8-28	20,0	37,0	25,0	12,0	14,0
1211900	R1A05ML05T-0404	1/4"	1/4-19	26,0	44,0	29,0	14,0	19,0
1211901	R1A05ML05T-0606	3/8"	3/8-19	27,0	49,0	31,0	17,0	22,0
1211902	R1A05ML05T-0808	1/2"	1/2-14	35,0	55,0	34,0	22,0	27,0
1211903	R1A05ML05T-1010	5/8"	5/8-14	38,0	59,0	37,0	22,0	32,0
1211904	R1A05ML05T-1212	3/4"	3/4-14	42,0	63,0	37,0	27,0	36,0
1211905	R1A05ML05T-1616	1"	1-11	47,0	69,0	41,0	33,0	41,0
1211906	R1A05ML05T-2020	1 1/4"	1 1/4-11	52,0	77,0	45,0	41,0	50,0
1211907	R1A05ML05T-2424	1 1/2"	1 1/2-11	60,0	87,0	49,0	48,0	55,0

// BSPP

// R1A05M106N

Straight connector

BSP 60° Male - BSPP cylindric Male with O-Ring and retaining ring

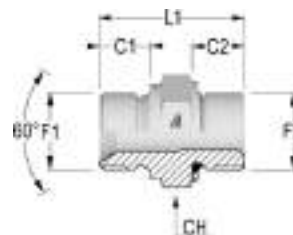

Item Code	Product Code	OD1	F1	F2	C1 (mm)	C2 (mm)	L1 (mm)	CH (mm)
1212043	R1A05M106N-0202	1/8"	1/8-28	1/8-28	8,0	7,5	21,5	14,0
1212044	R1A05M106N-0204	1/8"	1/8-28	1/4-19	8,0	11,0	28,0	19,0
1212046	R1A05M106N-0406	1/4"	1/4-19	3/8-19	11,0	11,0	31,0	22,0
1212047	R1A05M106N-0604	3/8"	3/8-19	1/4-19	13,0	13,0	33,0	22,0
1212048	R1A05M106N-0606	3/8"	3/8-19	3/8-19	13,0	11,0	34,0	22,0
1212049	R1A05M106N-0608	3/8"	3/8-19	1/2-14	13,0	14,5	38,0	27,0
1212050	R1A05M106N-0806	1/2"	1/2-14	3/8-19	16,0	11,0	35,0	27,0
1212051	R1A05M106N-0808	1/2"	1/2-14	1/2-14	16,0	16,0	40,0	27,0
1212052	R1A05M106N-0812	1/2"	1/2-14	3/4-14	16,0	14,5	40,0	32,0
1212053	R1A05M106N-1008	5/8"	5/8-14	1/2-14	16,0	14,5	38,5	27,0
1236668	R1A05M106N-1208	3/4"	3/4-14	1/2-14	17,0	14,5	44,0	32,0
1212055	R1A05M106N-1212	3/4"	3/4-14	3/4-14	17,0	14,5	46,0	32,0
1212056	R1A05M106N-1216	3/4"	3/4-14	1-11	17,0	18,5	52,0	41,0
1212057	R1A05M106N-1612	1"	1-11	3/4-14	19,0	14,5	49,0	41,0
1212058	R1A05M106N-1616	1"	1-11	1-11	19,0	18,5	55,0	41,0
1212059	R1A05M106N-1620	1"	1-11	1 1/4-11	19,0	18,5	60,0	50,0
1212060	R1A05M106N-2020	1 1/4"	1 1/4-11	1 1/4-11	20,0	18,5	62,5	50,0
1212061	R1A05M106N-2424	1 1/2"	1 1/2-11	1 1/2-11	22,0	18,5	63,0	55,0

Design and dimensions shown may be changed without prior notice

// R1A05M406N**45° adjustable elbow connector****BSP 60° Male - BSPP cylindric Male with O-Ring and retaining ring**

Item Code	Product Code	OD1	F1	F2	C1 (mm)	C2 (mm)	CH (mm)	LN (mm)
1212127	R1A05M406N-0202	1/8"	1/8-28	1/8-28	20,0	26,0	12,0	14,0
1212128	R1A05M406N-0204	1/8"	1/8-28	1/4-19	21,0	28,0	14,0	19,0
1210962	R1A05M406N-0404	1/4"	1/4-19	1/4-19	21,0	28,0	14,0	19,0
1212129	R1A05M406N-0406	1/4"	1/4-19	3/8-19	22,0	33,0	17,0	22,0
1212130	R1A05M406N-0604	3/8"	3/8-19	1/4-19	25,0	30,0	17,0	19,0
1212131	R1A05M406N-0606	3/8"	3/8-19	3/8-19	25,0	33,0	17,0	22,0
1212132	R1A05M406N-0608	3/8"	3/8-19	1/2-14	25,5	38,0	19,0	27,0
1212133	R1A05M406N-0806	1/2"	1/2-14	3/8-19	26,0	35,0	19,0	22,0
1212134	R1A05M406N-0808	1/2"	1/2-14	1/2-14	28,0	38,0	22,0	27,0
1212135	R1A05M406N-0810	1/2"	1/2-14	5/8-14	39,0	50,0	27,0	32,0
1212136	R1A05M406N-1008	5/8"	5/8-14	1/2-14	28,0	38,0	22,0	27,0
1212137	R1A05M406N-1208	3/4"	3/4-14	1/2-14	32,0	40,0	27,0	27,0
1212138	R1A05M406N-1212	3/4"	3/4-14	3/4-14	32,0	44,0	27,0	36,0
1212139	R1A05M406N-1216	3/4"	3/4-14	1-11	35,0	47,0	33,0	41,0
1212140	R1A05M406N-1612	1"	1-11	3/4-14	37,0	47,0	33,0	36,0
1212141	R1A05M406N-1616	1"	1-11	1-11	37,0	47,0	33,0	41,0
1212142	R1A05M406N-1620	1"	1-11	1 1/4-11	39,0	49,0	41,0	50,0
1212143	R1A05M406N-2020	1 1/4"	1 1/4-11	1 1/4-11	40,0	49,0	41,0	50,0
1212144	R1A05M406N-2424	1 1/2"	1 1/2-11	1 1/2-11	45,0	49,0	48,0	55,0

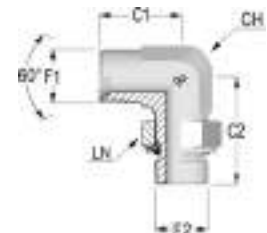
// R1A05M906N**90° adjustable elbow connector****BSP 60° Male - BSPP cylindric Male with O-Ring and retaining ring**

Item Code	Product Code	OD1	F1	F2	C1 (mm)	C2 (mm)	CH (mm)	LN (mm)
1212191	R1A05M906N-0202	1/8"	1/8-28	1/8-28	22,0	27,0	12,0	14,0
1212192	R1A05M906N-0204	1/8"	1/8-28	1/4-19	24,0	31,5	14,0	19,0
1208135	R1A05M906N-0404	1/4"	1/4-19	1/4-19	27,0	31,5	14,0	19,0
1212193	R1A05M906N-0406	1/4"	1/4-19	3/8-19	28,0	37,0	17,0	22,0
1212194	R1A05M906N-0604	3/8"	3/8-19	1/4-19	29,0	35,0	17,0	19,0
1207949	R1A05M906N-0606	3/8"	3/8-19	3/8-19	29,0	37,0	17,0	22,0
1212195	R1A05M906N-0608	3/8"	3/8-19	1/2-14	32,0	43,0	19,0	27,0
1212196	R1A05M906N-0806	1/2"	1/2-14	3/8-19	34,0	40,0	19,0	22,0
1207950	R1A05M906N-0808	1/2"	1/2-14	1/2-14	34,0	43,0	22,0	27,0
1212199	R1A05M906N-1208	3/4"	3/4-14	1/2-14	41,0	46,0	27,0	27,0
1208136	R1A05M906N-1212	3/4"	3/4-14	3/4-14	41,0	50,0	27,0	36,0
1212200	R1A05M906N-1216	3/4"	3/4-14	1-11	43,0	53,0	33,0	41,0
1212201	R1A05M906N-1612	1"	1-11	3/4-14	46,0	52,0	33,0	36,0
1210745	R1A05M906N-1616	1"	1-11	1-11	46,0	53,0	33,0	41,0
1212202	R1A05M906N-1620	1"	1-11	1 1/4-11	50,0	58,0	41,0	50,0
1210976	R1A05M906N-2020	1 1/4"	1 1/4-11	1 1/4-11	51,0	58,0	41,0	50,0
1210977	R1A05M906N-2424	1 1/2"	1 1/2-11	1 1/2-11	59,0	67,0	48,0	55,0

// R1A05MT06N

Branch Tee adjustable elbow connector

BSP 60° Male - BSPP cylindric Male with O-Ring and retaining ring

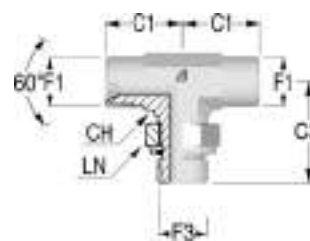

Item Code	Product Code	OD1	F1	F3	C1 (mm)	C3 (mm)	CH (mm)	LN (mm)
1211971	R1A05MT06N-0202	1/8"	1/8-28	1/8-28	22,0	27,0	12,0	14,0
1211972	R1A05MT06N-0204	1/8"	1/8-28	1/4-19	24,0	31,5	14,0	19,0
1208147	R1A05MT06N-0404	1/4"	1/4-19	1/4-19	27,0	31,5	14,0	19,0
1211973	R1A05MT06N-0406	1/4"	1/4-19	3/8-19	28,0	37,0	17,0	22,0
1211974	R1A05MT06N-0604	3/8"	3/8-19	1/4-19	29,0	35,0	17,0	19,0
1210749	R1A05MT06N-0606	3/8"	3/8-19	3/8-19	29,0	37,0	17,0	22,0
1211976	R1A05MT06N-0806	1/2"	1/2-14	3/8-19	34,0	40,0	19,0	22,0
1210713	R1A05MT06N-0808	1/2"	1/2-14	1/2-14	34,0	43,0	22,0	27,0
1211978	R1A05MT06N-1008	5/8"	5/8-14	1/2-14	37,0	43,0	22,0	27,0
1211979	R1A05MT06N-1208	3/4"	3/4-14	1/2-14	41,0	46,0	27,0	27,0
1210750	R1A05MT06N-1212	3/4"	3/4-14	3/4-14	41,0	50,0	27,0	36,0
1211980	R1A05MT06N-1216	3/4"	3/4-14	1-11	43,0	53,0	33,0	41,0
1211981	R1A05MT06N-1612	1"	1-11	3/4-14	46,0	52,0	33,0	36,0
1210947	R1A05MT06N-1616	1"	1-11	1-11	46,0	53,0	33,0	41,0
1207710	R1A05MT06N-1620	1"	1-11	1 1/4-11	50,0	58,0	41,0	50,0
1210948	R1A05MT06N-2020	1 1/4"	1 1/4-11	1 1/4-11	51,0	58,0	41,0	50,0
1210949	R1A05MT06N-2424	1 1/2"	1 1/2-11	1 1/2-11	59,0	67,0	48,0	55,0

// R1A05ML06N

Run Tee adjustable elbow connector

BSP 60° Male - BSPP cylindric Male with O-Ring and retaining ring

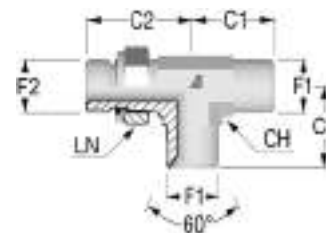

Item Code	Product Code	OD1	F1	F2	C1 (mm)	C2 (mm)	CH (mm)	LN (mm)
1211909	R1A05ML06N-0202	1/8"	1/8-28	1/8-28	22,0	27,0	12,0	14,0
1211910	R1A05ML06N-0204	1/8"	1/8-28	1/4-19	24,0	31,5	14,0	19,0
1210746	R1A05ML06N-0404	1/4"	1/4-19	1/4-19	27,0	31,5	14,0	19,0
1211911	R1A05ML06N-0406	1/4"	1/4-19	3/8-19	28,0	37,0	17,0	22,0
1211912	R1A05ML06N-0604	3/8"	3/8-19	1/4-19	29,0	35,0	17,0	19,0
1208140	R1A05ML06N-0606	3/8"	3/8-19	3/8-19	29,0	37,0	17,0	22,0
1211913	R1A05ML06N-0608	3/8"	3/8-19	1/2-14	32,0	43,0	19,0	27,0
1211914	R1A05ML06N-0806	1/2"	1/2-14	3/8-19	34,0	40,0	19,0	22,0
1208141	R1A05ML06N-0808	1/2"	1/2-14	1/2-14	34,0	43,0	22,0	27,0
1211915	R1A05ML06N-0810	1/2"	1/2-14	5/8-14	39,0	50,0	27,0	32,0
1211916	R1A05ML06N-1008	5/8"	5/8-14	1/2-14	37,0	43,0	22,0	27,0
1211917	R1A05ML06N-1208	3/4"	3/4-14	1/2-14	41,0	46,0	27,0	27,0
1210715	R1A05ML06N-1212	3/4"	3/4-14	3/4-14	41,0	50,0	27,0	36,0
1211918	R1A05ML06N-1216	3/4"	3/4-14	1-11	43,0	53,0	33,0	41,0
1211919	R1A05ML06N-1612	1"	1-11	3/4-14	46,0	52,0	33,0	36,0
1210942	R1A05ML06N-1616	1"	1-11	1-11	46,0	53,0	33,0	41,0
1210943	R1A05ML06N-1620	1"	1-11	1 1/4-11	50,0	58,0	41,0	50,0
1210944	R1A05ML06N-2020	1 1/4"	1 1/4-11	1 1/4-11	51,0	58,0	41,0	50,0
1210945	R1A05ML06N-2424	1 1/2"	1 1/2-11	1 1/2-11	59,0	67,0	48,0	55,0

Design and dimensions shown may be changed without prior notice

// FLANGES

// R1A05M133W

Straight flange SAE J518 code 61

BSP - Low pressure

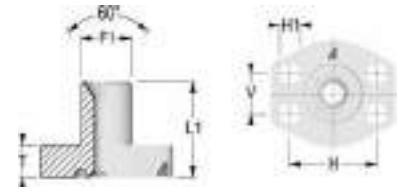

Item Code	Product Code	OD1	F1	F2	T (mm)	H1 (mm)	H (mm)	V (mm)	L1 (mm)	CH (mm)
1212081	R1A05M133W-0608	3/8"	3/8-19	1/2	14,0	9,0	38,1	17,5	37,0	
1212082	R1A05M133W-0808	1/2"	1/2-14	1/2	14,0	9,0	38,1	17,5	39,0	
1212083	R1A05M133W-0812	1/2"	1/2-14	3/4	15,0	11,0	47,6	22,2	42,0	
1212084	R1A05M133W-1208	3/4"	3/4-14	1/2	14,0	9,0	38,1	17,5	42,0	
1212085	R1A05M133W-1212	3/4"	3/4-14	3/4	15,0	11,0	47,6	22,2	45,0	
1212086	R1A05M133W-1216	3/4"	3/4-14	1	17,0	11,0	52,4	26,2	47,0	
1212087	R1A05M133W-1612	1"	1-11	3/4	15,0	11,0	47,6	22,2	47,0	
1212088	R1A05M133W-1616	1"	1-11	1	21,0	11,5	58,7	30,2	53,0	
1212089	R1A05M133W-2016	1"1/4	1 1/4-11	1	17,0	11,0	52,4	26,2	49,0	
1212090	R1A05M133W-2020	1"1/4	1 1/4-11	1 1/4	21,0	11,5	58,7	30,2	53,0	
1212091	R1A05M133W-2024	1"1/4	1 1/4-11	1 1/2	24,0	13,5	69,9	35,7	59,0	
1212092	R1A05M133W-2420	1"1/2	1 1/2-11	1 1/4	21,0	11,5	58,7	30,2	55,0	
1212093	R1A05M133W-2424	1"1/2	1 1/2-11	1 1/2	24,0	13,5	69,9	35,7	61,0	

// R1A05M136W

Straight flange SAE J518 code 62

BSP - High pressure

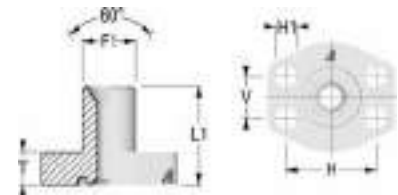

Item Code	Product Code	OD1	F1	F2	T (mm)	H1 (mm)	H (mm)	V (mm)	L1 (mm)
1212094	R1A05M136W-0608	3/8"	3/8-19	1/2	14,0	9,0	38,1	17,5	37,0
1212095	R1A05M136W-0808	1/2"	1/2-14	1/2	14,0	9,0	38,1	17,5	39,0
1212096	R1A05M136W-0812	1/2"	1/2-14	3/4	15,0	11,0	47,6	22,2	42,0
1212097	R1A05M136W-1208	3/4"	3/4-14	1/2	14,0	9,0	38,1	17,5	42,0
1212098	R1A05M136W-1212	3/4"	3/4-14	3/4	15,0	11,0	47,6	22,2	45,0
1212099	R1A05M136W-1216	3/4"	3/4-14	1	17,0	11,0	52,4	26,2	47,0
1212100	R1A05M136W-1612	1"	1-11	3/4	15,0	11,0	47,6	22,2	47,0
1212101	R1A05M136W-1616	1"	1-11	1	17,0	11,0	52,4	26,2	49,0
1212102	R1A05M136W-1620	1"	1-11	1 1/4	21,0	11,5	58,7	30,2	53,0
1212103	R1A05M136W-2016	1"1/4	1 1/4-11	1	17,0	11,0	52,4	26,2	49,0
1212104	R1A05M136W-2020	1"1/4	1 1/4-11	1 1/4	21,0	11,5	58,7	30,2	53,0
1212105	R1A05M136W-2024	1"1/4	1 1/4-11	1 1/2	24,0	13,5	69,9	35,7	59,0
1212106	R1A05M136W-2420	1"1/2	1 1/2-11	1 1/4	21,0	11,5	58,7	30,2	55,0
1212107	R1A05M136W-2424	1"1/2	1 1/2-11	1 1/2	24,0	13,5	69,9	35,7	61,0

// R1A05M933W

90° flange SAE J518 code 61

BSP - Low pressure

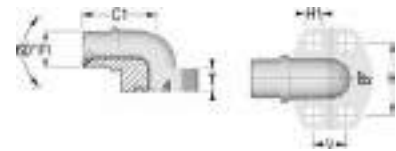

Item Code	Product Code	OD1	F1	F2	C1 (mm)	T (mm)	H1 (mm)	H (mm)	V (mm)
1212252	R1A05M933W-0608	3/8"	3/8-19	1/2	37,0	17,0	9,0	38,1	17,5
1212253	R1A05M933W-0808	1/2"	1/2-14	1/2	39,0	17,0	9,0	38,1	17,5
1212254	R1A05M933W-0812	1/2"	1/2-14	3/4	41,0	20,0	11,0	47,6	22,2
1212255	R1A05M933W-1208	3/4"	3/4-14	1/2	40,0	20,0	9,0	38,1	17,5
1212256	R1A05M933W-1212	3/4"	3/4-14	3/4	44,0	20,0	11,0	47,6	22,2
1212257	R1A05M933W-1216	3/4"	3/4-14	1	47,0	20,0	11,0	52,4	26,2
1212258	R1A05M933W-1612	1"	1-11	3/4	45,0	25,0	11,0	47,6	22,2
1212259	R1A05M933W-1616	1"	1-11	1	48,0	25,0	11,0	52,4	26,2
1212260	R1A05M933W-1620	1"	1-11	1 1/4	54,0	25,0	11,5	58,7	30,2
1212261	R1A05M933W-2016	1" 1/4	1 1/4-11	1	49,0	31,0	11,0	52,4	26,2
1212262	R1A05M933W-2020	1" 1/4	1 1/4-11	1 1/4	55,0	31,0	11,5	58,7	30,2
1212263	R1A05M933W-2024	1" 1/4	1 1/4-11	1 1/2	59,0	31,0	13,5	69,9	35,7
1212264	R1A05M933W-2420	1" 1/2	1 1/2-11	1 1/4	56,0	37,0	11,5	58,7	30,2
1212265	R1A05M933W-2424	1" 1/2	1 1/2-11	1 1/2	61,0	37,0	13,5	69,9	35,7

// R1A05M936W

90° flange SAE J518 code 62

BSP - High pressure

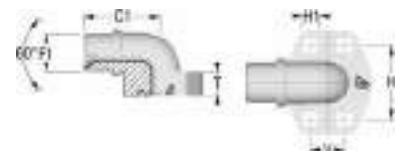

Item Code	Product Code	OD1	F1	F2	C1 (mm)	T (mm)	H1 (mm)	H (mm)	V (mm)
1212278	R1A05M936W-0608	3/8"	3/8-19	1/2	37,0	17,0	9,0	38,1	17,5
1212279	R1A05M936W-0808	1/2"	1/2-14	1/2	39,0	17,0	9,0	38,1	17,5
1212280	R1A05M936W-0812	1/2"	1/2-14	3/4	41,0	20,0	11,0	47,6	22,2
1212281	R1A05M936W-1208	3/4"	3/4-14	1/2	40,0	20,0	9,0	38,1	17,5
1212282	R1A05M936W-1212	3/4"	3/4-14	3/4	44,0	20,0	11,0	47,6	22,2
1212283	R1A05M936W-1216	3/4"	3/4-14	1	47,0	20,0	11,0	52,4	26,2
1212284	R1A05M936W-1612	1"	1-11	3/4	45,0	25,0	11,0	47,6	22,2
1212285	R1A05M936W-1616	1"	1-11	1	48,0	25,0	11,0	52,4	26,2
1212286	R1A05M936W-1620	1"	1-11	1 1/4	54,0	25,0	11,5	58,7	30,2
1212287	R1A05M936W-2016	1" 1/4	1 1/4-11	1	49,0	31,0	11,0	52,4	26,2
1212288	R1A05M936W-2020	1" 1/4	1 1/4-11	1 1/4	55,0	31,0	11,5	58,7	30,2
1212289	R1A05M936W-2024	1" 1/4	1 1/4-11	1 1/2	59,0	31,0	13,5	69,9	35,7
1212290	R1A05M936W-2420	1" 1/2	1 1/2-11	1 1/4	56,0	37,0	11,5	58,7	30,2
1212291	R1A05M936W-2424	1" 1/2	1 1/2-11	1 1/2	61,0	37,0	13,5	69,9	35,7

Design and dimensions shown may be changed without prior notice

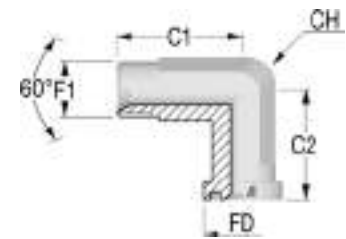
// R1A05M9334**90° adjustable flange SAE J518 code 61****BSP - Low pressure**

Item Code	Product Code	OD1	F1	F2	FD (mm)	C1 (mm)	C2 (mm)	CH (mm)
1212266	R1A05M9334-0608	3/8"	3/8-19	1/2	30,2	44,0	50,0	22,0
1212267	R1A05M9334-0808	1/2"	1/2-14	1/2	30,2	48,0	42,0	22,0
1212268	R1A05M9334-0812	1/2"	1/2-14	3/4	38,1	53,0	64,0	22,0
1212269	R1A05M9334-1212	3/4"	3/4-14	3/4	38,1	53,0	64,0	27,0
1212270	R1A05M9334-1216	3/4"	3/4-14	1	44,5	60,0	65,0	27,0
1212271	R1A05M9334-1612	1"	1-11	3/4	38,1	53,0	64,0	34,0
1212272	R1A05M9334-1616	1"	1-11	1	44,5	60,0	65,0	34,0
1212273	R1A05M9334-1620	1"	1-11	1 1/4	50,8	55,0	64,0	34,0
1212274	R1A05M9334-2016	1 1/4"	1 1/4-11	1	44,5	60,0	65,0	42,0
1212275	R1A05M9334-2020	1 1/4"	1 1/4-11	1 1/4	50,8	55,0	64,0	42,0
1212276	R1A05M9334-2024	1 1/4"	1 1/4-11	1 1/2	60,3	66,0	78,0	42,0
1212277	R1A05M9334-2424	1 1/2"	1 1/2-11	1 1/2	60,3	66,0	78,0	50,0

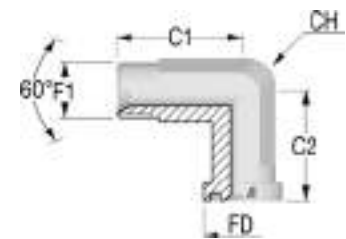
// R1A05M9364**90° adjustable flange SAE J518 code 62****BSP - High pressure**

Item Code	Product Code	OD1	F1	F2	FD (mm)	C1 (mm)	C2 (mm)	CH (mm)
1212292	R1A05M9364-0608	3/8"	3/8-19	1/2	31,8	44,0	50,0	22,0
1212293	R1A05M9364-0808	1/2"	1/2-14	1/2	31,8	49,0	43,0	22,0
1212294	R1A05M9364-0812	1/2"	1/2-14	3/4	41,3	53,0	64,0	22,0
1212295	R1A05M9364-1212	3/4"	3/4-14	3/4	41,3	53,0	64,0	27,0
1212296	R1A05M9364-1216	3/4"	3/4-14	1	47,6	60,0	62,0	27,0
1212297	R1A05M9364-1612	1"	1-11	3/4	41,3	59,5	54,5	30,0
1212298	R1A05M9364-1616	1"	1-11	1	47,6	60,0	62,0	34,0
1212299	R1A05M9364-1620	1"	1-11	1 1/4	54,0	70,0	72,0	34,0
1212300	R1A05M9364-2016	1 1/4"	1 1/4-11	1	47,6	72,0	70,0	41,0
1212301	R1A05M9364-2020	1 1/4"	1 1/4-11	1 1/4	54,0	70,0	72,0	42,0
1212302	R1A05M9364-2024	1 1/4"	1 1/4-11	1 1/2	63,5	80,0	84,0	42,0
1212303	R1A05M9364-2424	1 1/2"	1 1/2-11	1 1/2	63,5	80,0	84,0	50,0

// PLUG

// R1A0531000 Cap BSP 60° Female

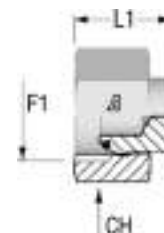

Item Code	Product Code	OD1	F1	L1 (mm)	CH (mm)
1207690	R1A0531000-0400	1/4"	1/4-19	19,0	19,0
1207691	R1A0531000-0600	3/8"	3/8-19	21,0	22,0
1207692	R1A0531000-0800	1/2"	1/2-14	23,3	27,0
1207693	R1A0531000-1000	5/8"	5/8-14	26,0	27,0
1207694	R1A0531000-1200	3/4"	3/4-14	21,5	32,0
1207695	R1A0531000-1600	1"	1-11	32,0	38,0
1207696	R1A0531000-2000	1"1/4	1 1/4-11	32,0	50,0
1210712	R1A0531000-2400	1"1/2	1 1/2-11	38,0	55,0

// R1A05M1000 Plug BSP 60° Male

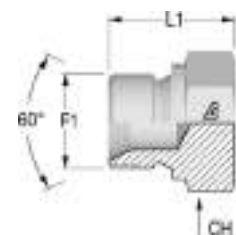

Item Code	Product Code	OD1	F1	L1 (mm)	CH (mm)
1207662	R1A05M1000-0200	1/8"	1/8-28	14,5	14,0
1207663	R1A05M1000-0400	1/4"	1/4-19	19,0	19,0
1207664	R1A05M1000-0600	3/8"	3/8-19	20,5	22,0
1207665	R1A05M1000-0800	1/2"	1/2-14	24,0	27,0
1210952	R1A05M1000-1000	5/8"	5/8-14	24,0	30,0
1207666	R1A05M1000-1200	3/4"	3/4-14	26,5	32,0
1207667	R1A05M1000-1600	1"	1-11	30,0	41,0
1207668	R1A05M1000-2000	1"1/4	1 1/4-11	39,0	50,0
1207669	R1A05M1000-2400	1"1/2	1 1/2-11	43,0	55,0



// DIN 24° ADAPTERS

// ACCESSORIES.....	298	// BSPP.....	356
// MALE UNION.....	301	// BSPT.....	378
// MALE/FEMALE UNION.....	309	// BUTT WELD.....	387
// BULKHEAD.....	331	// PLUG.....	391
// METRIC.....	335		

// ACCESSORIES

// RXA11D0000

Nut DIN 24°
Light Series

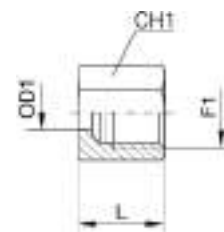

Item Code	Product Code	OD1	F1	L (mm)	CH1 (mm)
1240839	RXA11D0000-0600	6	M12X1.5	14,5	14,0
1240840	RXA11D0000-0800	8	M14X1.5	14,5	17,0
1240841	RXA11D0000-1000	10	M16X1.5	15,5	19,0
1240842	RXA11D0000-1200	12	M18X1.5	15,5	22,0
1240843	RXA11D0000-1500	15	M22X1.5	17,0	27,0
1240844	RXA11D0000-1800	18	M26X1.5	18,0	32,0
1240845	RXA11D0000-2200	22	M30X2	20,0	36,0
1240846	RXA11D0000-2800	28	M36X2	21,0	41,0
1240847	RXA11D0000-3500	35	M45X2	24,0	50,0
1240848	RXA11D0000-4200	42	M52X2	24,0	60,0

// RXA12D0000

Nut DIN 24°
Heavy Series

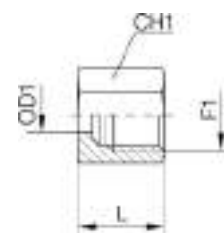

Item Code	Product Code	OD1	F1	L (mm)	CH1 (mm)
1240849	RXA12D0000-0600	6	M14X1.5	16,5	17,0
1240850	RXA12D0000-0800	8	M16X1.5	16,5	19,0
1240851	RXA12D0000-1000	10	M18X1.5	17,5	22,0
1240852	RXA12D0000-1200	12	M20X1.5	17,5	24,0
1246446	RXA12D0000-1400	14	M22X1.5	20,5	27,0
1235329	RXA12D0000-1600	16	M24X1.5	20,5	30,0
1237301	RXA12D0000-2000	20	M30X2	24,0	36,0
1240853	RXA12D0000-2500	25	M36X2	27,0	46,0
1240854	RXA12D0000-3000	30	M42X2	29,0	50,0
1240855	RXA12D0000-3800	38	M52X2	32,5	60,0

Design and dimensions shown may be changed without prior notice

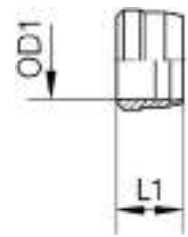
// R1A11R0000**Double cutting ring DIN 24°****Light Series**

Item Code	Product Code	OD1	L1 (mm)
1204137	R1A11R0000-0600	6	9,5
1204139	R1A11R0000-0800	8	9,5
1204109	R1A11R0000-1000	10	10,0
1204113	R1A11R0000-1200	12	10,0
1204118	R1A11R0000-1500	15	10,0
1204121	R1A11R0000-1800	18	10,5
1204125	R1A11R0000-2200	22	11,0
1204129	R1A11R0000-2800	28	11,0
1204133	R1A11R0000-3500	35	13,5
1204136	R1A11R0000-4200	42	13,5

Codes from 6 to 12 mm also Heavy Series.

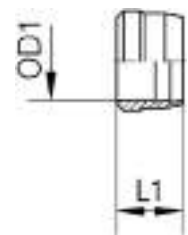
// R1A12R0000**Double cutting ring DIN 24°****Heavy Series**

Item Code	Product Code	OD1	L1 (mm)
1204117	R1A12R0000-1400	14	10,0
1204120	R1A12R0000-1600	16	10,5
1204124	R1A12R0000-2000	20	13,0
1204128	R1A12R0000-2500	25	13,0
1204131	R1A12R0000-3000	30	13,5
1204135	R1A12R0000-3800	38	13,5

Codes from 6 to 12 mm same as Light Series ones.

// R1A11R000B

Double cutting ring with tight sealing DIN 24°

Light Series

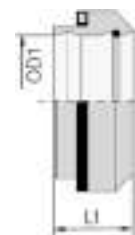

Item Code	Product Code	OD1	L1 (mm)
1244467	R1A11R0000-0600_B	6	9,0
1239498	R1A11R0000-0800_B	8	8,0
1244468	R1A11R0000-1000_B	10	9,3
1237046	R1A11R0000-1200_B	12	9,5
1241104	R1A11R0000-1500_B	15	9,5
1241106	R1A11R0000-1800_B	18	9,5
1237047	R1A11R0000-2200_B	22	11,5
1237048	R1A11R0000-2800_B	28	11,5
1241110	R1A11R0000-3500_B	35	13,0
1244469	R1A11R0000-4200_B	42	13,0

Codes from 6 to 12 mm also Heavy Series.

// R1A12R000B

Double cutting ring with tight sealing DIN 24°

Heavy Series

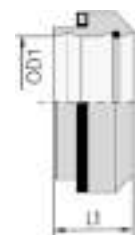

Item Code	Product Code	OD1	L1 (mm)
1244470	R1A12R0000-1400_B	14	10,0
1239871	R1A12R0000-1600_B	16	10,0
1239870	R1A12R0000-2000_B	20	13,0
1237071	R1A12R0000-2500_B	25	13,3
1241138	R1A12R0000-3000_B	30	14,0
1244471	R1A12R0000-3800_B	38	14,0

Codes from 6 to 12 mm same as Light Series ones.

Design and dimensions shown may be changed without prior notice

// MALE UNION

// R1A11M111M

Straight union DIN 24° Male
Light Series

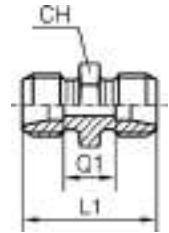

Item Code	Product Code	OD1	Q1 (mm)	L1 (mm)	CH (mm)
1205544	R1A11M111M-0606	6	10,0	24,0	12,0
1205546	R1A11M111M-0808	8	11,0	25,0	14,0
1205537	R1A11M111M-1010	10	13,0	27,0	17,0
1204233	R1A11M111M-1212	12	14,0	28,0	19,0
1204234	R1A11M111M-1515	15	16,0	30,0	24,0
1205538	R1A11M111M-1818	18	16,0	31,0	27,0
1205541	R1A11M111M-2222	22	20,0	35,0	32,0
1205708	R1A11M111M-2828	28	21,0	36,0	41,0
1205709	R1A11M111M-3535	35	20,0	41,0	46,0
1205710	R1A11M111M-4242	42	21,0	43,0	55,0

// R1E11M111M

Straight union DIN 24° Male
Light Series
Complete

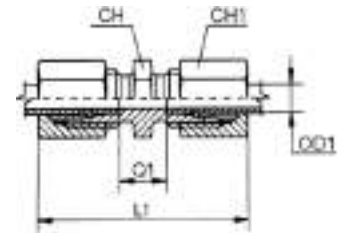

Item Code	Product Code	OD1	Q1 (mm)	L1 (mm)	CH (mm)	CH1 (mm)
1240805	R1A11M111M-0606_A	6	10,0	39,0	12,0	14,0
1240806	R1A11M111M-0808_A	8	11,0	40,0	14,0	17,0
1240807	R1A11M111M-1010_A	10	13,0	42,0	17,0	19,0
1240808	R1A11M111M-1212_A	12	14,0	43,0	19,0	22,0
1241077	R1A11M111M-1515_A	15	16,0	46,0	24,0	27,0
1243784	R1A11M111M-1818_A	18	16,0	48,0	27,0	32,0
1242417	R1A11M111M-2222_A	22	20,0	52,0	32,0	36,0
1243785	R1A11M111M-2828_A	28	21,0	54,0	41,0	41,0
1243786	R1A11M111M-3535_A	35	20,0	63,0	46,0	50,0
1241080	R1A11M111M-4242_A	42	21,0	66,0	55,0	60,0

// R1A12M112M

**Straight union DIN 24° Male
Heavy Series**

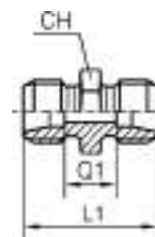

Item Code	Product Code	OD1	Q1 (mm)	L1 (mm)	CH (mm)
1206097	R1A12M112M-0606	6	16,0	30,0	14,0
1205687	R1A12M112M-0808	8	18,0	32,0	17,0
1205688	R1A12M112M-1010	10	17,0	32,0	19,0
1205689	R1A12M112M-1212	12	19,0	34,0	22,0
1205690	R1A12M112M-1414	14	22,0	38,0	24,0
1205691	R1A12M112M-1616	16	21,0	38,0	27,0
1205539	R1A12M112M-2020	20	23,0	44,0	32,0
1205542	R1A12M112M-2525	25	26,0	50,0	41,0
1205543	R1A12M112M-3030	30	27,0	54,0	46,0
1205711	R1A12M112M-3838	38	29,0	61,0	55,0

// R1E12M112M

**Straight union DIN 24° Male
Heavy Series
Complete**

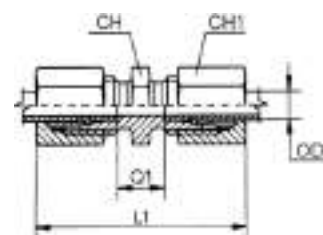

Item Code	Product Code	OD1	Q1 (mm)	L1 (mm)	CH (mm)	CH1 (mm)
1244127	R1A12M112M-0606_A	6	16,0	45,0	14,0	17,0
1244128	R1A12M112M-0808_A	8	18,0	47,0	17,0	19,0
1244129	R1A12M112M-1010_A	10	17,0	49,0	19,0	22,0
1244130	R1A12M112M-1212_A	12	19,0	51,0	22,0	24,0
1244131	R1A12M112M-1414_A	14	22,0	57,0	24,0	27,0
1244132	R1A12M112M-1616_A	16	21,0	57,0	27,0	30,0
1241122	R1A12M112M-2020_A	20	23,0	66,0	32,0	36,0
1241125	R1A12M112M-2525_A	25	26,0	74,0	41,0	46,0
1244133	R1A12M112M-3030_A	30	27,0	80,0	46,0	50,0
1244134	R1A12M112M-3838_A	38	29,0	90,0	55,0	60,0

Design and dimensions shown may be changed without prior notice

// R1A11M911M

90° union DIN 24° Male

Light Series

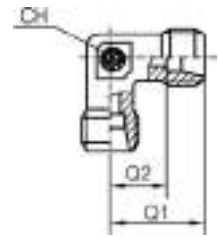

Item Code	Product Code	OD1	Q1 (mm)	Q2 (mm)	CH (mm)
1205692	R1A11M911M-0606	6	19,0	12,0	12,0
1205693	R1A11M911M-0808	8	21,0	14,0	12,0
1205694	R1A11M911M-1010	10	22,0	15,0	14,0
1204062	R1A11M911M-1212	12	24,0	17,0	17,0
1204064	R1A11M911M-1515	15	28,0	21,0	19,0
1205695	R1A11M911M-1818	18	31,0	23,5	24,0
1205696	R1A11M911M-2222	22	35,0	27,5	27,0
1205697	R1A11M911M-2828	28	38,0	30,5	36,0
1205707	R1A11M911M-3535	35	45,0	34,5	41,0
1206043	R1A11M911M-4242	42	51,0	40,0	50,0

// R1E11M911M

90° union DIN 24° Male

Light Series

Complete

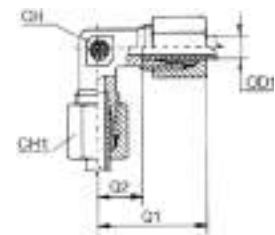

Item Code	Product Code	OD1	Q1 (mm)	Q2 (mm)	CH (mm)	CH1 (mm)
1243861	R1A11M911M-0606_A	6	27,0	12,0	12,0	14,0
1241534	R1A11M911M-0808_A	8	29,0	14,0	12,0	17,0
1240812	R1A11M911M-1010_A	10	30,0	15,0	14,0	19,0
1243862	R1A11M911M-1212_A	12	32,0	17,0	17,0	22,0
1243863	R1A11M911M-1515_A	15	36,0	21,0	19,0	27,0
1243864	R1A11M911M-1818_A	18	40,0	23,5	24,0	32,0
1243865	R1A11M911M-2222_A	22	44,0	27,5	27,0	36,0
1243866	R1A11M911M-2828_A	28	47,0	30,5	36,0	41,0
1243867	R1A11M911M-3535_A	35	56,0	34,5	41,0	50,0
1243868	R1A11M911M-4242_A	42	63,0	40,0	50,0	60,0

// R1A12M912M

90° union DIN 24° Male

Heavy series

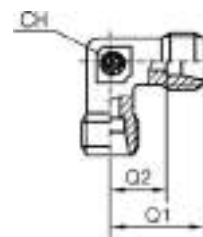

Item Code	Product Code	OD1	Q1 (mm)	Q2 (mm)	CH (mm)
1205698	R1A12M912M-0606	6	23,0	16,0	12,0
1205699	R1A12M912M-0808	8	24,0	17,0	14,0
1205700	R1A12M912M-1010	10	25,0	17,5	17,0
1205701	R1A12M912M-1212	12	29,0	21,5	17,0
1205702	R1A12M912M-1414	14	30,0	22,0	19,0
1205703	R1A12M912M-1616	16	33,0	24,5	24,0
1205704	R1A12M912M-2020	20	37,0	26,5	27,0
1242137	R1A12M912M-2525	25	42,0	30,0	36,0
1205706	R1A12M912M-3030	30	49,0	35,5	41,0
1207042	R1A12M912M-3838	38	57,0	41,0	50,0

// R1E12M912M

90° union DIN 24° Male

Heavy Series

Complete

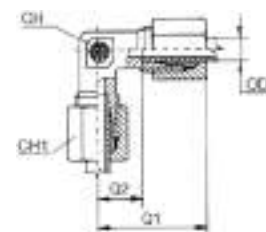

Item Code	Product Code	OD1	Q1 (mm)	Q2 (mm)	CH (mm)	CH1 (mm)
1244224	R1A12M912M-0606_A	6	31,0	16,0	12,0	17,0
1244225	R1A12M912M-0808_A	8	32,0	17,0	14,0	19,0
1244226	R1A12M912M-1010_A	10	34,0	17,5	17,0	22,0
1244227	R1A12M912M-1212_A	12	38,0	21,5	17,0	24,0
1244228	R1A12M912M-1414_A	14	40,0	22,0	19,0	27,0
1244229	R1A12M912M-1616_A	16	43,0	24,5	24,0	30,0
1244230	R1A12M912M-2020_A	20	48,0	26,5	27,0	36,0
1205705	R1A12M912M-2525_A	25	54,0	30,0	36,0	46,0
1244231	R1A12M912M-3030_A	30	62,0	35,5	41,0	50,0
1244232	R1A12M912M-3838_A	38	72,0	41,0	50,0	60,0

Design and dimensions shown may be changed without prior notice

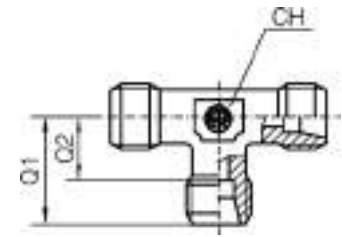
// R1A11MT11M**Branch Tee union DIN 24° Male****Light Series**

Item Code	Product Code	OD1	Q1 (mm)	Q2 (mm)	CH (mm)
1204218	R1A11MT11M-0606	6	19,0	12,0	12,0
1204219	R1A11MT11M-0808	8	21,0	14,0	14,0
1204215	R1A11MT11M-1010	10	22,0	15,0	17,0
1204216	R1A11MT11M-1212	12	24,0	17,0	19,0
1204217	R1A11MT11M-1515	15	28,0	21,0	19,0
1205712	R1A11MT11M-1818	18	31,0	23,5	24,0
1205713	R1A11MT11M-2222	22	35,0	27,5	27,0
1205714	R1A11MT11M-2828	28	38,0	30,5	36,0
1205715	R1A11MT11M-3535	35	45,0	34,5	41,0
1206042	R1A11MT11M-4242	42	51,0	40,0	50,0

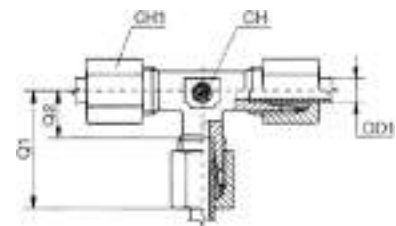
// R1E11MT11M**Branch Tee union DIN 24° Male****Light Series****Complete**

Item Code	Product Code	OD1	Q1 (mm)	Q2 (mm)	CH (mm)	CH1 (mm)
1241542	R1A11MT11M-0606_A	6	27,0	12,0	12,0	14,0
1240813	R1A11MT11M-0808_A	8	29,0	14,0	14,0	17,0
1240814	R1A11MT11M-1010_A	10	30,0	15,0	17,0	19,0
1241099	R1A11MT11M-1212_A	12	32,0	17,0	19,0	22,0
1242245	R1A11MT11M-1515_A	15	36,0	21,0	19,0	27,0
1243981	R1A11MT11M-1818_A	18	40,0	23,5	24,0	32,0
1243982	R1A11MT11M-2222_A	22	44,0	27,5	27,0	36,0
1243983	R1A11MT11M-2828_A	28	47,0	30,5	36,0	41,0
1243984	R1A11MT11M-3535_A	35	56,0	34,5	41,0	50,0
1243985	R1A11MT11M-4242_A	42	63,0	40,0	50,0	60,0

// R1A12MT12M

**Branch Tee union DIN 24° Male
Heavy series**

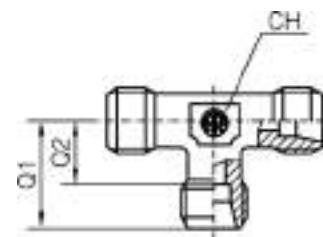

Item Code	Product Code	OD1	Q1 (mm)	Q2 (mm)	CH (mm)
1205716	R1A12MT12M-0606	6	23,0	16,0	12,0
1205717	R1A12MT12M-0808	8	24,0	17,0	14,0
1205718	R1A12MT12M-1010	10	25,0	17,5	17,0
1205719	R1A12MT12M-1212	12	29,0	21,5	17,0
1205720	R1A12MT12M-1414	14	30,0	22,0	19,0
1205616	R1A12MT12M-1616	16	33,0	24,5	24,0
1205721	R1A12MT12M-2020	20	37,0	26,5	27,0
1205722	R1A12MT12M-2525	25	42,0	30,0	36,0
1205723	R1A12MT12M-3030	30	49,0	35,5	41,0
1205724	R1A12MT12M-3838	38	57,0	41,0	50,0

// R1E12MT12M

**Branch Tee union DIN 24° Male
Heavy Series
Complete**

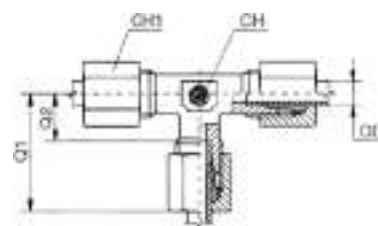

Item Code	Product Code	OD1	Q1 (mm)	Q2 (mm)	CH (mm)	CH1 (mm)
1244350	R1A12MT12M-0606_A	6	31,0	16,0	12,0	17,0
1244351	R1A12MT12M-0808_A	8	32,0	17,0	14,0	19,0
1244352	R1A12MT12M-1010_A	10	34,0	17,5	17,0	22,0
1244353	R1A12MT12M-1212_A	12	38,0	21,5	17,0	24,0
1244354	R1A12MT12M-1414_A	14	40,0	22,0	19,0	27,0
1244355	R1A12MT12M-1616_A	16	43,0	24,5	24,0	30,0
1244356	R1A12MT12M-2020_A	20	48,0	26,5	27,0	36,0
1244357	R1A12MT12M-2525_A	25	54,0	30,0	36,0	46,0
1244358	R1A12MT12M-3030_A	30	62,0	35,5	41,0	50,0
1244359	R1A12MT12M-3838_A	38	72,0	41,0	50,0	60,0

Design and dimensions shown may be changed without prior notice

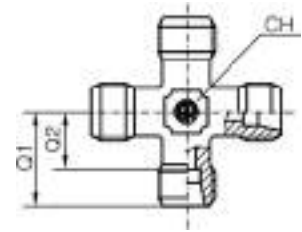
// R1A11MX11M**Cross union DIN 24° Male****Light Series**

Item Code	Product Code	OD1	Q1 (mm)	Q2 (mm)	CH (mm)
1205725	R1A11MX11M-0606	6	19,0	12,0	12,0
1205726	R1A11MX11M-0808	8	21,0	14,0	12,0
1205727	R1A11MX11M-1010	10	22,0	15,0	14,0
1205755	R1A11MX11M-1212	12	24,0	17,0	17,0
1205728	R1A11MX11M-1515	15	28,0	21,0	19,0
1205729	R1A11MX11M-1818	18	31,0	23,5	24,0
1205730	R1A11MX11M-2222	22	35,0	27,5	27,0
1211083	R1A11MX11M-2828	28	38,0	30,5	36,0
1211084	R1A11MX11M-3535	35	45,0	34,5	41,0
1211085	R1A11MX11M-4242	42	51,0	40,0	50,0

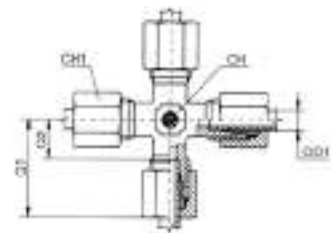
// R1E11MX11M**Cross union DIN 24° Male****Light Series****Complete**

Item Code	Product Code	OD1	Q1 (mm)	Q2 (mm)	CH (mm)	CH1 (mm)
1244005	R1A11MX11M-0606_A	6	27,0	12,0	12,0	14,0
1244006	R1A11MX11M-0808_A	8	29,0	14,0	12,0	17,0
1242918	R1A11MX11M-1010_A	10	30,0	15,0	14,0	19,0
1244007	R1A11MX11M-1212_A	12	32,0	17,0	17,0	22,0
1244008	R1A11MX11M-1515_A	15	36,0	21,0	19,0	27,0
1244009	R1A11MX11M-1818_A	18	40,0	23,5	24,0	32,0
1244010	R1A11MX11M-2222_A	22	44,0	27,5	27,0	36,0
1244011	R1A11MX11M-2828_A	28	47,0	30,5	36,0	41,0
1244012	R1A11MX11M-3535_A	35	56,0	34,5	41,0	50,0
1244013	R1A11MX11M-4242_A	42	63,0	40,0	50,0	60,0

// R1A12MX12M

**Cross union DIN 24° Male
Heavy Series**

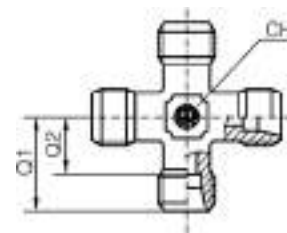

Item Code	Product Code	OD1	Q1 (mm)	Q2 (mm)	CH (mm)
1206376	R1A12MX12M-0606	6	23,0	16,0	12,0
1206356	R1A12MX12M-0808	8	24,0	17,0	14,0
1206308	R1A12MX12M-1010	10	25,0	17,5	17,0
1206128	R1A12MX12M-1212	12	29,0	21,5	17,0
1206241	R1A12MX12M-1414	14	30,0	22,0	19,0
1206242	R1A12MX12M-1616	16	33,0	24,5	24,0
1206570	R1A12MX12M-2020	20	37,0	26,5	27,0
1206571	R1A12MX12M-2525	25	42,0	30,0	36,0
1208138	R1A12MX12M-3030	30	49,0	35,5	41,0
1211263	R1A12MX12M-3838	38	57,0	41,0	50,0

// R1E12MX12M

**Cross union DIN 24° Male
Heavy Series
Complete**

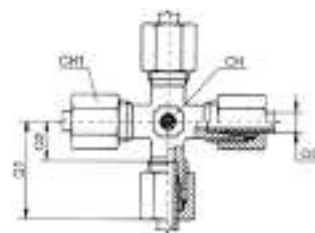

Item Code	Product Code	OD1	Q1 (mm)	Q2 (mm)	CH (mm)	CH1 (mm)
1244379	R1A12MX12M-0606_A	6	31,0	16,0	12,0	17,0
1244380	R1A12MX12M-0808_A	8	32,0	17,0	14,0	19,0
1244381	R1A12MX12M-1010_A	10	34,0	17,5	17,0	22,0
1244382	R1A12MX12M-1212_A	12	38,0	21,5	17,0	24,0
1244383	R1A12MX12M-1414_A	14	40,0	22,0	19,0	27,0
1244384	R1A12MX12M-1616_A	16	43,0	24,5	24,0	30,0
1244385	R1A12MX12M-2020_A	20	48,0	26,5	27,0	36,0
1244386	R1A12MX12M-2525_A	25	54,0	30,0	36,0	46,0
1244387	R1A12MX12M-3030_A	30	62,0	35,5	41,0	50,0
1244388	R1A12MX12M-3838_A	38	72,0	41,0	50,0	60,0

Design and dimensions shown may be changed without prior notice

// MALE/FEMALE UNION

// R1A11M1113

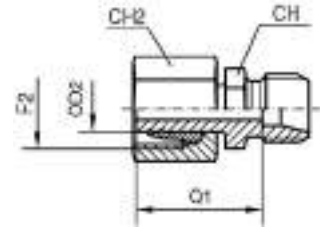
Reducers DIN 24° pre-assembled
Light Series

Item Code	Product Code	OD1	OD2	F2	Q1 (mm)	CH (mm)	CH2 (mm)
1205622	R1A11M1113-0608	6	8	M14X1.5	29,5	14,0	17,0
1205623	R1A11M1113-0610	6	10	M16X1.5	29,5	14,0	19,0
1205617	R1A11M1113-0612	6	12	M18X1.5	29,5	14,0	22,0
1205621	R1A11M1113-0615	6	15	M22X1.5	29,5	17,0	27,0
1205627	R1A11M1113-0618	6	18	M26X1.5	30,5	19,0	32,0
1207824	R1A11M1113-0622	6	22	M30X2	33,5	24,0	36,0
1207825	R1A11M1113-0628	6	28	M36X2	34,5	32,0	41,0
1210999	R1A11M1113-0635	6	35	M45X2	40,5	36,0	50,0
1205624	R1A11M1113-0810	8	10	M16X1.5	29,5	17,0	19,0
1205618	R1A11M1113-0812	8	12	M18X1.5	29,5	17,0	22,0
1205620	R1A11M1113-0815	8	15	M22X1.5	29,5	17,0	27,0
1205628	R1A11M1113-0818	8	18	M26X1.5	30,5	19,0	32,0
1206843	R1A11M1113-0822	8	22	M30X2	33,5	24,0	36,0
1207826	R1A11M1113-0828	8	28	M36X2	34,5	32,0	41,0
1211000	R1A11M1113-0835	8	35	M45X2	40,5	36,0	50,0
1205619	R1A11M1113-1012	10	12	M18X1.5	31,0	17,0	22,0
1205625	R1A11M1113-1015	10	15	M22X1.5	31,0	17,0	27,0
1205629	R1A11M1113-1018	10	18	M26X1.5	32,0	19,0	32,0
1206562	R1A11M1113-1022	10	22	M30X2	35,0	24,0	36,0
1207827	R1A11M1113-1028	10	28	M36X2	36,0	32,0	41,0
1211001	R1A11M1113-1035	10	35	M45X2	42,0	36,0	50,0
1211004	R1A11M1113-1042	10	42	M52X2	44,0	46,0	60,0
1205626	R1A11M1113-1215	12	15	M22X1.5	31,0	19,0	27,0
1205630	R1A11M1113-1218	12	18	M26X1.5	32,0	19,0	32,0
1205632	R1A11M1113-1222	12	22	M30X2	35,0	24,0	36,0
1205635	R1A11M1113-1228	12	28	M36X2	36,0	32,0	41,0
1211002	R1A11M1113-1235	12	35	M45X2	42,0	36,0	50,0
1211005	R1A11M1113-1242	12	42	M52X2	43,0	46,0	60,0
1205631	R1A11M1113-1518	15	18	M26X1.5	32,5	24,0	32,0
1205633	R1A11M1113-1522	15	22	M30X2	35,5	24,0	36,0
1205636	R1A11M1113-1528	15	28	M36X2	36,5	32,0	41,0
1211003	R1A11M1113-1535	15	35	M45X2	42,5	36,0	50,0
1211006	R1A11M1113-1542	15	42	M52X2	44,5	46,0	60,0
1205634	R1A11M1113-1822	18	22	M30X2	35,0	27,0	36,0
1205637	R1A11M1113-1828	18	28	M36X2	36,0	32,0	41,0
1208154	R1A11M1113-1835	18	35	M45X2	42,0	36,0	50,0
1207828	R1A11M1113-1842	18	42	M52X2	44,0	46,0	60,0
1205638	R1A11M1113-2228	22	28	M36X2	36,0	32,0	41,0
1205639	R1A11M1113-2235	22	35	M45X2	44,0	36,0	50,0
1205641	R1A11M1113-2242	22	42	M52X2	46,0	46,0	60,0
1205640	R1A11M1113-2835	28	35	M45X2	44,0	41,0	50,0

// R1E11M1113
Reducers DIN 24° pre-assembled
Light Series
Complete

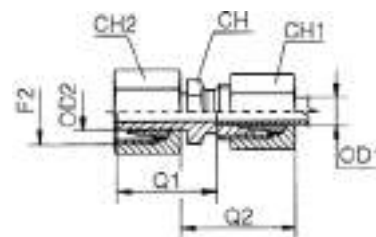

Item Code	Product Code	OD1	OD2	F2	Q1 (mm)	Q2 (mm)	CH (mm)	CH1 (mm)	CH2 (mm)
1243748	R1A11M1113-0608_A	6	8	M14X1.5	29,5	30,0	14,0	14,0	17,0
1241527	R1A11M1113-0610_A	6	10	M16X1.5	29,5	30,0	14,0	22,0	14,0
1243749	R1A11M1113-0612_A	6	12	M18X1.5	29,5	30,0	14,0	14,0	22,0
1243750	R1A11M1113-0615_A	6	15	M22X1.5	29,5	29,0	17,0	14,0	27,0
1243751	R1A11M1113-0618_A	6	18	M26X1.5	30,5	29,0	19,0	14,0	32,0
1243752	R1A11M1113-0622_A	6	22	M30X2	33,5	32,0	24,0	14,0	36,0
1243753	R1A11M1113-0628_A	6	28	M36X2	34,5	33,0	32,0	14,0	41,0
1243754	R1A11M1113-0635_A	6	35	M45X2	40,5	34,0	36,0	14,0	50,0
1243803	R1A11M1113-0810_A	8	10	M16X1.5	29,5	30,0	14,0	17,0	19,0
1243755	R1A11M1113-0812_A	8	12	M18X1.5	29,5	30,0	17,0	17,0	22,0
1243756	R1A11M1113-0815_A	8	15	M22X1.5	29,5	29,0	17,0	17,0	27,0
1243757	R1A11M1113-0818_A	8	18	M26X1.5	30,5	29,0	19,0	17,0	32,0
1243758	R1A11M1113-0822_A	8	22	M30X2	33,5	32,0	24,0	17,0	36,0
1243759	R1A11M1113-0828_A	8	28	M36X2	34,5	33,0	32,0	17,0	41,0
1243760	R1A11M1113-0835_A	8	35	M45X2	40,5	34,0	36,0	17,0	50,0
1241528	R1A11M1113-1012_A	10	12	M18X1.5	31,0	31,0	17,0	22,0	19,0
1241955	R1A11M1113-1015_A	10	15	M22X1.5	31,0	30,0	17,0	27,0	19,0
1243761	R1A11M1113-1018_A	10	18	M26X1.5	32,0	30,0	19,0	19,0	32,0
1243762	R1A11M1113-1022_A	10	22	M30X2	35,0	33,0	24,0	19,0	36,0
1243763	R1A11M1113-1028_A	10	28	M36X2	36,0	34,0	32,0	19,0	41,0
1243764	R1A11M1113-1035_A	10	35	M45X2	42,0	35,0	36,0	19,0	50,0
1243765	R1A11M1113-1042_A	10	42	M52X2	44,0	36,0	46,0	19,0	60,0
1241552	R1A11M1113-1215_A	12	15	M22X1.5	31,0	30,0	19,0	27,0	22,0
1243766	R1A11M1113-1218_A	12	18	M26X1.5	32,0	30,0	19,0	22,0	32,0
1243767	R1A11M1113-1222_A	12	22	M30X2	35,0	33,0	24,0	22,0	36,0
1243768	R1A11M1113-1228_A	12	28	M36X2	36,0	34,0	32,0	22,0	41,0
1243769	R1A11M1113-1235_A	12	35	M45X2	42,0	35,0	36,0	22,0	50,0
1243770	R1A11M1113-1242_A	12	42	M52X2	43,0	36,0	46,0	22,0	60,0
1243771	R1A11M1113-1518_A	15	18	M26X1.5	32,5	32,0	24,0	27,0	32,0
1243772	R1A11M1113-1522_A	15	22	M30X2	35,5	35,0	24,0	27,0	36,0
1243773	R1A11M1113-1528_A	15	28	M36X2	36,5	35,0	32,0	27,0	41,0
1243774	R1A11M1113-1535_A	15	35	M45X2	42,5	36,0	36,0	27,0	50,0
1243775	R1A11M1113-1542_A	15	42	M52X2	44,5	37,0	46,0	27,0	60,0
1243776	R1A11M1113-1822_A	18	22	M30X2	35,0	35,0	27,0	32,0	36,0
1243777	R1A11M1113-1828_A	18	28	M36X2	36,0	36,0	32,0	32,0	41,0
1243778	R1A11M1113-1835_A	18	35	M45X2	42,0	37,0	36,0	32,0	50,0
1243779	R1A11M1113-1842_A	18	42	M52X2	44,0	38,0	46,0	32,0	60,0
1243780	R1A11M1113-2228_A	22	28	M36X2	36,0	38,0	32,0	36,0	41,0
1243781	R1A11M1113-2235_A	22	35	M45X2	44,0	39,0	36,0	36,0	50,0
1243782	R1A11M1113-2242_A	22	42	M52X2	46,0	40,0	46,0	36,0	60,0
1243783	R1A11M1113-2835_A	28	35	M45X2	44,0	39,0	41,0	41,0	50,0

Design and dimensions shown may be changed without prior notice

// R1A12M1123

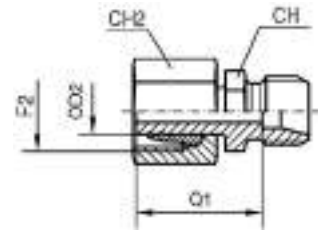
**Reducers DIN 24° pre-assembled
Heavy Series**

Item Code	Product Code	OD1	OD2	F2	Q1 (mm)	CH (mm)	CH2 (mm)
1205644	R1A12M1123-0608	6	8	M16X1.5	31,0	17,0	19,0
1205645	R1A12M1123-0610	6	10	M18X1.5	32,0	17,0	22,0
1205647	R1A12M1123-0612	6	12	M20X1.5	33,0	17,0	24,0
1206338	R1A12M1123-0614	6	14	M22X1.5	37,0	17,0	27,0
1206340	R1A12M1123-0616	6	16	M24X1.5	37,0	17,0	30,0
1207857	R1A12M1123-0620	6	20	M30X2	43,0	22,0	36,0
1211188	R1A12M1123-0625	6	25	M36X2	47,0	27,0	46,0
1211189	R1A12M1123-0630	6	30	M42X2	49,0	32,0	50,0
1205646	R1A12M1123-0810	8	10	M18X1.5	32,0	17,0	22,0
1205648	R1A12M1123-0812	8	12	M20X1.5	33,0	17,0	24,0
1205650	R1A12M1123-0814	8	14	M22X1.5	37,0	17,0	27,0
1205653	R1A12M1123-0816	8	16	M24X1.5	37,0	17,0	30,0
1206362	R1A12M1123-0820	8	20	M30X2	43,0	22,0	36,0
1206884	R1A12M1123-0825	8	25	M36X2	47,0	27,0	46,0
1211190	R1A12M1123-0830	8	30	M42X2	49,0	32,0	50,0
1205649	R1A12M1123-1012	10	12	M20X1.5	32,5	19,0	24,0
1205651	R1A12M1123-1014	10	14	M22X1.5	36,5	19,0	27,0
1205654	R1A12M1123-1016	10	16	M24X1.5	36,5	19,0	30,0
1205657	R1A12M1123-1020	10	20	M30X2	42,5	22,0	36,0
1205661	R1A12M1123-1025	10	25	M36X2	46,5	27,0	46,0
1211191	R1A12M1123-1030	10	30	M42X2	48,5	32,0	50,0
1205652	R1A12M1123-1214	12	14	M22X1.5	36,5	22,0	27,0
1205658	R1A12M1123-1220	12	20	M30X2	42,5	22,0	36,0
1205662	R1A12M1123-1225	12	25	M36X2	46,5	27,0	46,0
1206563	R1A12M1123-1230	12	30	M42X2	48,5	32,0	50,0
1205656	R1A12M1123-1416	14	16	M24X1.5	38,0	24,0	30,0
1205659	R1A12M1123-1420	14	20	M30X2	44,0	24,0	36,0
1206339	R1A12M1123-1425	14	25	M36X2	48,0	27,0	46,0
1206846	R1A12M1123-1430	14	30	M42X2	50,0	32,0	50,0
1211195	R1A12M1123-1438	14	38	M52X2	57,0	41,0	60,0
1205660	R1A12M1123-1620	16	20	M30X2	43,5	27,0	36,0
1205663	R1A12M1123-1625	16	25	M36X2	47,5	27,0	46,0
1205665	R1A12M1123-1630	16	30	M42X2	49,5	32,0	50,0
1207858	R1A12M1123-1638	16	38	M52X2	56,5	41,0	60,0
1205664	R1A12M1123-2025	20	25	M36X2	47,5	32,0	46,0
1205666	R1A12M1123-2030	20	30	M42X2	49,5	32,0	50,0
1205668	R1A12M1123-2038	20	38	M52X2	56,5	41,0	60,0
1205667	R1A12M1123-2530	25	30	M42X2	50,0	41,0	50,0
1205669	R1A12M1123-2538	25	38	M52X2	57,0	41,0	60,0

// R1E12M1123

**Reducers DIN 24° pre-assembled
Heavy Series
Complete**

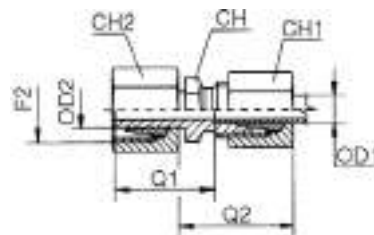

Item Code	Product Code	OD1	OD2	F2	Q1 (mm)	Q2 (mm)	CH (mm)	CH1 (mm)	CH2 (mm)
1244088	R1A12M1123-0608_A	6	8	M16X1.5	31,0	31,0	17,0	17,0	19,0
1244089	R1A12M1123-0610_A	6	10	M18X1.5	32,0	31,0	17,0	17,0	22,0
1244090	R1A12M1123-0612_A	6	12	M20X1.5	33,0	32,0	17,0	17,0	24,0
1244091	R1A12M1123-0614_A	6	14	M22X1.5	37,0	34,0	17,0	17,0	27,0
1244092	R1A12M1123-0616_A	6	16	M24X1.5	37,0	34,0	17,0	17,0	30,0
1244093	R1A12M1123-0620_A	6	20	M30X2	43,0	36,0	22,0	17,0	36,0
1244094	R1A12M1123-0625_A	6	25	M36X2	47,0	38,0	27,0	17,0	46,0
1244095	R1A12M1123-0630_A	6	30	M42X2	49,0	37,0	32,0	17,0	50,0
1244096	R1A12M1123-0810_A	8	10	M18X1.5	32,0	31,0	17,0	19,0	22,0
1244097	R1A12M1123-0812_A	8	12	M20X1.5	33,0	32,0	17,0	19,0	24,0
1244098	R1A12M1123-0814_A	8	14	M22X1.5	37,0	34,0	17,0	19,0	27,0
1244099	R1A12M1123-0816_A	8	16	M24X1.5	37,0	34,0	17,0	19,0	30,0
1244100	R1A12M1123-0820_A	8	20	M30X2	43,0	36,0	22,0	19,0	36,0
1244101	R1A12M1123-0825_A	8	25	M36X2	47,0	38,0	27,0	19,0	46,0
1244102	R1A12M1123-0830_A	8	30	M42X2	49,0	37,0	32,0	19,0	50,0
1244103	R1A12M1123-1012_A	10	12	M20X1.5	32,5	33,0	19,0	22,0	24,0
1244104	R1A12M1123-1014_A	10	14	M22X1.5	36,5	35,0	19,0	22,0	27,0
1244105	R1A12M1123-1016_A	10	16	M24X1.5	36,5	35,0	19,0	22,0	30,0
1244106	R1A12M1123-1020_A	10	20	M30X2	42,5	37,0	22,0	22,0	36,0
1244107	R1A12M1123-1025_A	10	25	M36X2	46,5	39,0	27,0	22,0	46,0
1244108	R1A12M1123-1030_A	10	30	M42X2	48,5	38,0	32,0	22,0	50,0
1244109	R1A12M1123-1214_A	12	14	M22X1.5	36,5	35,0	22,0	24,0	27,0
1244110	R1A12M1123-1220_A	12	20	M30X2	42,5	37,0	22,0	24,0	36,0
1244111	R1A12M1123-1225_A	12	25	M36X2	46,5	39,0	27,0	24,0	46,0
1244112	R1A12M1123-1230_A	12	30	M42X2	48,5	38,0	32,0	24,0	50,0
1244113	R1A12M1123-1416_A	14	16	M24X1.5	38,0	38,0	24,0	27,0	30,0
1244114	R1A12M1123-1420_A	14	20	M30X2	44,0	40,0	24,0	27,0	36,0
1244115	R1A12M1123-1425_A	14	25	M36X2	48,0	42,0	27,0	27,0	46,0
1244116	R1A12M1123-1430_A	14	30	M42X2	50,0	41,0	32,0	27,0	50,0
1244117	R1A12M1123-1438_A	14	38	M52X2	57,0	42,0	41,0	27,0	60,0
1244118	R1A12M1123-1620_A	16	20	M30X2	43,5	40,0	27,0	30,0	36,0
1244119	R1A12M1123-1625_A	16	25	M36X2	47,5	42,0	27,0	30,0	46,0
1244120	R1A12M1123-1630_A	16	30	M42X2	49,5	41,0	32,0	30,0	50,0
1244121	R1A12M1123-1638_A	16	38	M52X2	56,5	42,0	41,0	30,0	60,0
1244122	R1A12M1123-2025_A	20	25	M36X2	47,5	45,0	32,0	36,0	46,0
1244123	R1A12M1123-2030_A	20	30	M42X2	49,5	45,0	32,0	36,0	50,0
1244124	R1A12M1123-2038_A	20	38	M52X2	56,5	46,0	41,0	36,0	60,0
1244125	R1A12M1123-2530_A	25	30	M42X2	50,0	48,0	41,0	46,0	50,0
1244126	R1A12M1123-2538_A	25	38	M52X2	57,0	49,0	41,0	46,0	60,0

Design and dimensions shown may be changed without prior notice

// R1A11M1152

Reducers DIN 24° with O-Ring

Light Series

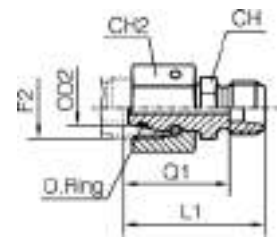

Item Code	Product Code	OD1	OD2	F2	Q1 (mm)	L1 (mm)	CH (mm)	CH2 (mm)
1211354	R1A11M1152-0608	6	8	M14X1.5	23,5	30,5	12,0	17,0
1211355	R1A11M1152-0610	6	10	M16X1.5	25,0	32,0	14,0	19,0
1211357	R1A11M1152-0612	6	12	M18X1.5	25,0	32,0	17,0	22,0
1211359	R1A11M1152-0615	6	15	M22X1.5	28,5	35,5	19,0	27,0
1211361	R1A11M1152-0618	6	18	M26X1.5	28,0	35,0	24,0	32,0
1211365	R1A11M1152-0622	6	22	M30X2	32,0	39,0	27,0	36,0
1211371	R1A11M1152-0628	6	28	M36X2	34,0	41,0	32,0	41,0
1211356	R1A11M1152-0810	8	10	M16X1.5	25,0	32,0	14,0	19,0
1208070	R1A11M1152-0812	8	12	M18X1.5	25,0	32,0	17,0	22,0
1208071	R1A11M1152-0815	8	15	M22X1.5	28,5	35,5	19,0	27,0
1211362	R1A11M1152-0818	8	18	M26X1.5	28,0	35,0	24,0	32,0
1211366	R1A11M1152-0822	8	22	M30X2	32,0	39,0	27,0	36,0
1211372	R1A11M1152-0828	8	28	M36X2	34,0	41,0	32,0	41,0
1211358	R1A11M1152-1012	10	12	M18X1.5	26,0	33,0	17,0	22,0
1208072	R1A11M1152-1015	10	15	M22X1.5	29,5	36,5	19,0	27,0
1211363	R1A11M1152-1018	10	18	M26X1.5	29,0	36,0	24,0	32,0
1211373	R1A11M1152-1028	10	28	M36X2	35,0	42,0	32,0	41,0
1211360	R1A11M1152-1215	12	15	M22X1.5	29,5	36,5	19,0	27,0
1208073	R1A11M1152-1218	12	18	M26X1.5	29,0	36,0	24,0	32,0
1211367	R1A11M1152-1222	12	22	M30X2	33,0	40,0	27,0	36,0
1211374	R1A11M1152-1228	12	28	M36X2	35,0	42,0	32,0	41,0
1211364	R1A11M1152-1518	15	18	M26X1.5	30,0	37,0	24,0	32,0
1211368	R1A11M1152-1522	15	22	M30X2	34,0	41,0	27,0	36,0
1211375	R1A11M1152-1528	15	28	M36X2	36,0	43,0	32,0	41,0
1211377	R1A11M1152-1535	15	35	M45X2	39,0	46,0	41,0	50,0
1211369	R1A11M1152-1822	18	22	M30X2	33,5	41,0	27,0	36,0
1208082	R1A11M1152-1828	18	28	M36X2	36,5	44,0	32,0	41,0
1211378	R1A11M1152-1835	18	35	M45X2	38,5	46,0	41,0	50,0
1211379	R1A11M1152-1842	18	42	M52X2	42,0	49,5	50,0	60,0
1211376	R1A11M1152-2228	22	28	M36X2	37,5	45,0	32,0	41,0
1208083	R1A11M1152-2235	22	35	M45X2	40,5	48,0	41,0	50,0
1211380	R1A11M1152-2242	22	42	M52X2	44,0	49,5	50,0	60,0
1211381	R1A11M1152-2842	28	42	M52X2	44,0	51,5	50,0	60,0
1211382	R1A11M1152-3542	35	42	M52X2	43,0	53,5	50,0	60,0

// R1E11M1152

Reducers DIN 24° with O-Ring
Light Series
Complete

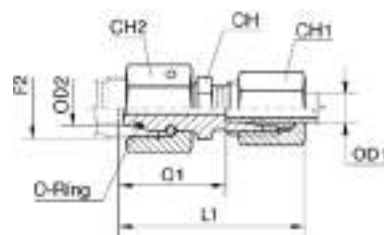

Item Code	Product Code	OD1	OD2	F2	Q1 (mm)	L1 (mm)	CH (mm)	CH1 (mm)	CH2 (mm)
1243796	R1A11M1152-0608_A	6	8	M14X1.5	23,5	38,0	12,0	14,0	17,0
1243797	R1A11M1152-0610_A	6	10	M16X1.5	25,0	40,0	14,0	14,0	19,0
1243798	R1A11M1152-0612_A	6	12	M18X1.5	25,0	40,0	17,0	14,0	22,0
1243799	R1A11M1152-0615_A	6	15	M22X1.5	28,5	43,0	19,0	14,0	27,0
1243800	R1A11M1152-0618_A	6	18	M26X1.5	28,0	43,0	24,0	14,0	32,0
1243801	R1A11M1152-0622_A	6	22	M30X2	32,0	47,0	27,0	14,0	36,0
1243802	R1A11M1152-0628_A	6	28	M36X2	34,0	49,0	32,0	14,0	41,0
1241551	R1A11M1152-0810_A	8	10	M16X1.5	25,0	40,0	14,0	17,0	19,0
1243804	R1A11M1152-0812_A	8	12	M18X1.5	25,0	40,0	17,0	17,0	22,0
1243805	R1A11M1152-0815_A	8	15	M22X1.5	28,5	43,0	19,0	17,0	27,0
1243806	R1A11M1152-0818_A	8	18	M26X1.5	28,0	43,0	24,0	17,0	32,0
1243807	R1A11M1152-0822_A	8	22	M30X2	32,0	47,0	27,0	17,0	36,0
1243808	R1A11M1152-0828_A	8	28	M36X2	34,0	49,0	32,0	17,0	41,0
1243809	R1A11M1152-1012_A	10	12	M18X1.5	26,0	41,0	17,0	19,0	22,0
1243810	R1A11M1152-1015_A	10	15	M22X1.5	29,5	44,0	19,0	19,0	27,0
1243811	R1A11M1152-1018_A	10	18	M26X1.5	29,0	44,0	24,0	19,0	32,0
1243812	R1A11M1152-1028_A	10	28	M36X2	35,0	50,0	32,0	19,0	41,0
1243813	R1A11M1152-1215_A	12	15	M22X1.5	29,5	44,0	19,0	22,0	27,0
1243814	R1A11M1152-1218_A	12	18	M26X1.5	29,0	44,0	24,0	22,0	32,0
1243815	R1A11M1152-1222_A	12	22	M30X2	33,0	48,0	27,0	22,0	36,0
1243816	R1A11M1152-1228_A	12	28	M36X2	35,0	50,0	32,0	22,0	41,0
1243817	R1A11M1152-1518_A	15	18	M26X1.5	30,0	45,0	24,0	27,0	32,0
1243818	R1A11M1152-1522_A	15	22	M30X2	34,0	49,0	27,0	27,0	36,0
1243819	R1A11M1152-1528_A	15	28	M36X2	36,0	51,0	32,0	27,0	41,0
1243820	R1A11M1152-1535_A	15	35	M45X2	39,0	54,0	41,0	27,0	50,0
1243821	R1A11M1152-1822_A	18	22	M30X2	33,5	50,0	27,0	32,0	36,0
1243822	R1A11M1152-1828_A	18	28	M36X2	36,5	52,0	32,0	32,0	41,0
1243823	R1A11M1152-1835_A	18	35	M45X2	38,5	55,0	41,0	32,0	50,0
1243824	R1A11M1152-1842_A	18	42	M52X2	42,0	58,0	50,0	32,0	60,0
1243825	R1A11M1152-2228_A	22	28	M36X2	37,5	54,0	32,0	36,0	41,0
1243826	R1A11M1152-2235_A	22	35	M45X2	40,5	57,0	41,0	36,0	50,0
1243827	R1A11M1152-2242_A	22	42	M52X2	44,0	60,0	50,0	36,0	60,0
1243828	R1A11M1152-2842_A	28	42	M52X2	44,0	61,0	50,0	41,0	60,0
1243829	R1A11M1152-3542_A	35	42	M52X2	43,0	65,0	50,0	50,0	60,0

// R1A12M1162

Reducers DIN 24° with O-Ring
Heavy Series

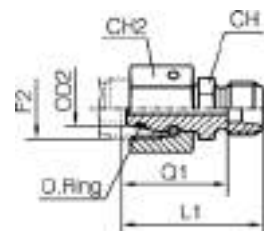

Item Code	Product Code	OD1	OD2	F2	Q1 (mm)	L1 (mm)	CH (mm)	CH2 (mm)
1211411	R1A12M1162-0608	6	8	M16X1.5	27,0	34,0	14,0	19,0
1211412	R1A12M1162-0610	6	10	M18X1.5	27,5	34,5	17,0	22,0
1211414	R1A12M1162-0612	6	12	M20X1.5	29,0	36,0	17,0	24,0
1211417	R1A12M1162-0614	6	14	M22X1.5	31,5	38,5	19,0	27,0
1207967	R1A12M1162-0616	6	16	M24X1.5	32,0	39,0	22,0	30,0

Design and dimensions shown may be changed without prior notice

Item Code	Product Code	OD1	OD2	F2	Q1 (mm)	L1 (mm)	CH (mm)	CH2 (mm)
1211423	R1A12M1162-0620	6	20	M30X2	36,0	43,0	27,0	36,0
1211427	R1A12M1162-0625	6	25	M36X2	38,5	45,5	32,0	46,0
1211433	R1A12M1162-0630	6	30	M42X2	44,0	51,0	41,0	50,0
1211413	R1A12M1162-0810	8	10	M18X1.5	27,5	34,5	17,0	22,0
1211415	R1A12M1162-0812	8	12	M20X1.5	29,0	36,0	17,0	24,0
1211418	R1A12M1162-0814	8	14	M22X1.5	31,5	38,5	19,0	27,0
1211421	R1A12M1162-0816	8	16	M24X1.5	32,0	39,0	22,0	30,0
1211424	R1A12M1162-0820	8	20	M30X2	36,0	43,0	27,0	36,0
1211428	R1A12M1162-0825	8	25	M36X2	38,5	45,5	32,0	46,0
1211434	R1A12M1162-0830	8	30	M42X2	44,0	51,0	41,0	50,0
1211416	R1A12M1162-1012	10	12	M20X1.5	29,5	37,0	19,0	24,0
1211419	R1A12M1162-1014	10	14	M22X1.5	31,0	38,5	19,0	27,0
1208068	R1A12M1162-1016	10	16	M24X1.5	31,5	39,0	22,0	30,0
1211425	R1A12M1162-1020	10	20	M30X2	35,5	43,0	27,0	36,0
1211429	R1A12M1162-1025	10	25	M36X2	38,0	45,5	32,0	46,0
1211435	R1A12M1162-1030	10	30	M42X2	43,5	51,0	41,0	50,0
1211420	R1A12M1162-1214	12	14	M22X1.5	31,0	38,5	22,0	27,0
1242333	R1A12M1162-1216	12	16	M24X1.5	31,5	39,0	22,0	30,0
1208165	R1A12M1162-1220	12	20	M30X2	35,5	43,0	27,0	36,0
1211430	R1A12M1162-1225	12	25	M36X2	38,0	45,5	32,0	46,0
1211436	R1A12M1162-1230	12	30	M42X2	43,5	51,0	41,0	50,0
1211422	R1A12M1162-1416	14	16	M24X1.5	33,0	41,0	24,0	30,0
1211426	R1A12M1162-1420	14	20	M30X2	37,0	45,0	27,0	36,0
1211431	R1A12M1162-1425	14	25	M36X2	39,5	47,5	32,0	46,0
1211437	R1A12M1162-1430	14	30	M42X2	45,0	53,0	41,0	50,0
1211442	R1A12M1162-1438	14	38	M52X2	48,5	56,5	50,0	60,0
1208166	R1A12M1162-1620	16	20	M30X2	36,5	45,0	27,0	36,0
1208167	R1A12M1162-1625	16	25	M36X2	39,0	47,5	32,0	46,0
1211438	R1A12M1162-1630	16	30	M42X2	44,5	54,0	41,0	50,0
1211443	R1A12M1162-1638	16	38	M52X2	48,0	56,5	50,0	60,0
1211432	R1A12M1162-2025	20	25	M36X2	39,0	49,5	32,0	46,0
1207987	R1A12M1162-2030	20	30	M42X2	44,5	55,0	41,0	50,0
1211444	R1A12M1162-2038	20	38	M52X2	48,0	58,5	50,0	60,0
1207963	R1A12M1162-2530	25	30	M42X2	45,0	57,0	41,0	50,0
1211445	R1A12M1162-2538	25	38	M52X2	48,5	60,5	50,0	60,0
1211446	R1A12M1162-3038	30	38	M52X2	49,0	62,5	50,0	60,0

// R1E12M1162

Reducers DIN 24° with O-Ring
Heavy Series
Complete

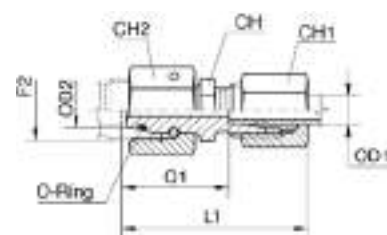

Item Code	Product Code	OD1	OD2	F2	Q1 (mm)	L1 (mm)	CH (mm)	CH1 (mm)	CH2 (mm)
1244144	R1A12M1162-0608_A	6	8	M16X1.5	27,0	42,0	14,0	17,0	19,0
1244145	R1A12M1162-0610_A	6	10	M18X1.5	27,5	42,0	17,0	17,0	22,0
1244146	R1A12M1162-0612_A	6	12	M20X1.5	29,0	44,0	17,0	17,0	24,0
1244147	R1A12M1162-0614_A	6	14	M22X1.5	31,5	46,0	19,0	17,0	27,0
1244148	R1A12M1162-0616_A	6	16	M24X1.5	32,0	47,0	22,0	17,0	30,0
1244149	R1A12M1162-0620_A	6	20	M30X2	36,0	51,0	27,0	17,0	36,0
1244150	R1A12M1162-0625_A	6	25	M36X2	38,5	53,0	32,0	17,0	46,0
1244151	R1A12M1162-0630_A	6	30	M42X2	44,0	59,0	41,0	17,0	50,0
1244152	R1A12M1162-0810_A	8	10	M18X1.5	27,5	42,0	17,0	19,0	22,0
1244153	R1A12M1162-0812_A	8	12	M20X1.5	29,0	44,0	17,0	19,0	24,0
1244154	R1A12M1162-0814_A	8	14	M22X1.5	31,5	46,0	19,0	19,0	27,0
1244155	R1A12M1162-0816_A	8	16	M24X1.5	32,0	47,0	22,0	19,0	30,0

Item Code	Product Code	OD1	OD2	F2	Q1 (mm)	L1 (mm)	CH (mm)	CH1 (mm)	CH2 (mm)
1244156	R1A12M1162-0820_A	8	20	M30X2	36,0	51,0	27,0	19,0	36,0
1244157	R1A12M1162-0825_A	8	25	M36X2	38,5	53,0	32,0	19,0	46,0
1244158	R1A12M1162-0830_A	8	30	M42X2	44,0	59,0	41,0	19,0	50,0
1244159	R1A12M1162-1012_A	10	12	M20X1.5	29,5	46,0	19,0	22,0	24,0
1244160	R1A12M1162-1014_A	10	14	M22X1.5	31,0	47,0	19,0	22,0	27,0
1244161	R1A12M1162-1016_A	10	16	M24X1.5	31,5	48,0	22,0	22,0	30,0
1244162	R1A12M1162-1020_A	10	20	M30X2	35,5	52,0	27,0	22,0	36,0
1244163	R1A12M1162-1025_A	10	25	M36X2	38,0	54,0	32,0	22,0	46,0
1244164	R1A12M1162-1030_A	10	30	M42X2	43,5	60,0	41,0	22,0	50,0
1244165	R1A12M1162-1214_A	12	14	M22X1.5	31,0	47,0	22,0	24,0	27,0
1244166	R1A12M1162-1216_A	12	16	M24X1.5	31,5	48,0	22,0	24,0	30,0
1244167	R1A12M1162-1220_A	12	20	M30X2	35,5	52,0	27,0	24,0	36,0
1244168	R1A12M1162-1225_A	12	25	M36X2	38,0	54,0	32,0	24,0	46,0
1244169	R1A12M1162-1230_A	12	30	M42X2	43,5	60,0	41,0	24,0	50,0
1244170	R1A12M1162-1416_A	14	16	M24X1.5	33,0	51,0	24,0	27,0	30,0
1244171	R1A12M1162-1420_A	14	20	M30X2	37,0	55,0	27,0	27,0	36,0
1244172	R1A12M1162-1425_A	14	25	M36X2	39,5	57,0	32,0	27,0	46,0
1244173	R1A12M1162-1430_A	14	30	M42X2	45,0	63,0	41,0	27,0	50,0
1244174	R1A12M1162-1438_A	14	38	M52X2	48,5	66,0	50,0	27,0	60,0
1244175	R1A12M1162-1620_A	16	20	M30X2	36,5	55,0	27,0	30,0	36,0
1244176	R1A12M1162-1625_A	16	25	M36X2	39,0	57,0	32,0	30,0	46,0
1244177	R1A12M1162-1630_A	16	30	M42X2	44,5	63,0	41,0	30,0	50,0
1244178	R1A12M1162-1638_A	16	38	M52X2	48,0	66,0	50,0	30,0	60,0
1244179	R1A12M1162-2025_A	20	25	M36X2	39,0	61,0	32,0	36,0	46,0
1244180	R1A12M1162-2030_A	20	30	M42X2	44,5	66,0	41,0	36,0	50,0
1244181	R1A12M1162-2038_A	20	38	M52X2	48,0	70,0	50,0	36,0	60,0
1244182	R1A12M1162-2530_A	25	30	M42X2	45,0	69,0	41,0	46,0	50,0
1244183	R1A12M1162-2538_A	25	38	M52X2	48,5	73,0	50,0	46,0	60,0
1244184	R1A12M1162-3038_A	30	38	M52X2	49,0	76,0	50,0	50,0	60,0

// R1A11M4152

45° adjustable elbow connector
 DIN 24° Male - Female with O-Ring
 Light Series



Item Code	Product Code	OD1	F1	Q1 (mm)	Q2 (mm)	Q3 (mm)	CH (mm)	CH2 (mm)
1244869	R1A11M4152-0606	6	M12X1.5	20,0	9,5	26,0	14,0	14,0
1244870	R1A11M4152-0808	8	M14X1.5	21,0	12,0	27,5	14,0	17,0
1241985	R1A11M4152-1010	10	M16X1.5	22,5	12,0	29,0	19,0	19,0
1208305	R1A11M4152-1212	12	M18X1.5	24,0	14,0	29,5	19,0	22,0
1244871	R1A11M4152-1515	15	M22X1.5	28,0	17,0	32,5	22,0	27,0
1244872	R1A11M4152-1818	18	M26X1.5	31,0	17,0	35,5	27,0	32,0
1244873	R1A11M4152-2222	22	M30X2	35,0	19,5	38,5	33,0	36,0
1244874	R1A11M4152-2828	28	M36X2	38,0	23,0	41,5	41,0	41,0
1244875	R1A11M4152-3535	35	M45X2	45,0	27,0	51,0	48,0	50,0
1244876	R1A11M4152-4242	42	M52X2	51,0	26,0	56,0	48,0	60,0

Design and dimensions shown may be changed without prior notice

// R1E11M4152**45° adjustable elbow connector****DIN 24° Male - Female with O-Ring****Light Series****Complete**

Item Code	Product Code	OD1	F2	Q1 (mm)	Q2 (mm)	Q3 (mm)	CH (mm)	CH1 (mm)	CH2 (mm)
1244939	R1A11M4152-0606_A	6	M12X1.5	24,5	9,5	26,0	14,0	14,0	14,0
1244940	R1A11M4152-0808_A	8	M14X1.5	27,0	12,0	27,5	14,0	17,0	17,0
1244941	R1A11M4152-1010_A	10	M16X1.5	27,0	12,0	29,0	19,0	19,0	19,0
1244942	R1A11M4152-1212_A	12	M18X1.5	29,0	14,0	29,5	19,0	22,0	22,0
1244943	R1A11M4152-1515_A	15	M22X1.5	32,0	17,0	32,5	22,0	27,0	27,0
1244944	R1A11M4152-1818_A	18	M26X1.5	33,0	17,0	35,5	27,0	32,0	32,0
1244945	R1A11M4152-2222_A	22	M30X2	35,5	19,5	38,5	33,0	36,0	36,0
1244946	R1A11M4152-2828_A	28	M36X2	39,0	23,0	41,5	41,0	41,0	41,0
1244947	R1A11M4152-3535_A	35	M45X2	48,0	27,0	51,0	48,0	50,0	50,0
1244948	R1A11M4152-4242_A	42	M52X2	49,0	26,0	56,0	48,0	60,0	60,0

// R1A12M4162**45° adjustable elbow connector****DIN 24° Male - Female with O-Ring****Heavy Series**

Item Code	Product Code	OD1	F1	Q1 (mm)	Q2 (mm)	Q3 (mm)	CH (mm)	CH2 (mm)
1244894	R1A12M4162-0606	6	M14X1.5	23,0	11,0	27,0	14,0	17,0
1244895	R1A12M4162-0808	8	M16X1.5	24,0	13,0	27,5	19,0	19,0
1244896	R1A12M4162-1010	10	M18X1.5	25,0	13,0	30,0	19,0	22,0
1244897	R1A12M4162-1212	12	M20X1.5	29,0	17,0	31,0	22,0	24,0
1244898	R1A12M4162-1616	16	M24X1.5	33,0	16,0	36,5	27,0	30,0
1244899	R1A12M4162-2020	20	M30X2	37,0	19,0	44,5	33,0	36,0
1244900	R1A12M4162-2525	25	M36X2	42,0	22,0	50,0	41,0	46,0
1244901	R1A12M4162-3030	30	M42X2	49,0	24,0	55,0	48,0	50,0
1244902	R1A12M4162-3838	38	M52X2	57,0	24,0	63,0	48,0	60,0

// R1E12M4162

45° adjustable elbow connector
DIN 24° Male - Female with O-Ring
Heavy Series
Complete



Item Code	Product Code	OD1	F2	Q1 (mm)	Q2 (mm)	Q3 (mm)	CH (mm)	CH1 (mm)	CH2 (mm)
1245008	R1A12M4162-0606_A	6	M14X1.5	26,0	11,0	27,0	14,0	17,0	17,0
1245009	R1A12M4162-0808_A	8	M16X1.5	28,0	13,0	27,5	19,0	19,0	19,0
1245010	R1A12M4162-1010_A	10	M18X1.5	29,0	13,0	30,0	19,0	22,0	22,0
1245011	R1A12M4162-1212_A	12	M20X1.5	33,0	17,0	31,0	22,0	24,0	24,0
1245012	R1A12M4162-1616_A	16	M24X1.5	34,0	16,0	36,5	27,0	30,0	30,0
1245013	R1A12M4162-2020_A	20	M30X2	40,0	19,0	44,5	33,0	36,0	36,0
1245014	R1A12M4162-2525_A	25	M36X2	46,0	22,0	50,0	41,0	46,0	46,0
1245015	R1A12M4162-3030_A	30	M42X2	50,0	24,0	55,0	48,0	50,0	50,0
1245016	R1A12M4162-3838_A	38	M52X2	55,0	24,0	63,0	48,0	60,0	60,0

// R1A11M9113

90° adjustable elbow connector
DIN 24° Male - Female pre-assembled
Light Series

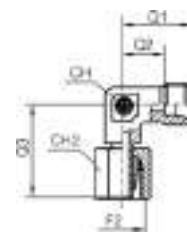

Item Code	Product Code	OD1	OD2	F1	Q1 (mm)	Q2 (mm)	Q3 (mm)	CH (mm)	CH2 (mm)
1206164	R1A11M9113-0606	6	6	M12X1.5	19,0	12,0	26,0	12,0	14,0
1205536	R1A11M9113-0808	8	8	M14X1.5	21,0	14,0	27,5	12,0	17,0
1204070	R1A11M9113-1010	10	10	M16X1.5	22,0	15,0	29,0	14,0	19,0
1242246	R1A11M9113-1212	12	12	M18X1.5	24,0	17,0	29,5	17,0	22,0
1204072	R1A11M9113-1515	15	15	M22X1.5	28,0	21,0	32,5	19,0	27,0
1205756	R1A11M9113-1818	18	18	M26X1.5	31,0	23,5	35,5	24,0	32,0
1205731	R1A11M9113-2222	22	22	M30X2	35,0	27,5	38,5	27,0	36,0
1206045	R1A11M9113-2828	28	28	M36X2	38,0	30,5	41,5	36,0	41,0
1206044	R1A11M9113-3535	35	35	M45X2	45,0	34,5	51,0	41,0	50,0
1205535	R1A11M9113-4242	42	42	M52X2	51,0	40,0	60,0	50,0	60,0

Design and dimensions shown may be changed without prior notice

// R1E11M9113**90° adjustable elbow connector****DIN 24° Male - Female pre-assembled****Light Series****Complete**

Item Code	Product Code	OD1	F2	Q1 (mm)	Q2 (mm)	Q3 (mm)	CH (mm)	CH1 (mm)	CH2 (mm)
1241531	R1A11M9113-0606_A	6	M12X1.5	27,0	12,0	26,0	12,0	14,0	14,0
1240810	R1A11M9113-0808_A	8	M14X1.5	29,0	14,0	27,5	12,0	17,0	17,0
1240811	R1A11M9113-1010_A	10	M16X1.5	30,0	15,0	29,0	14,0	19,0	19,0
1241532	R1A11M9113-1212_A	12	M18X1.5	32,0	17,0	29,5	17,0	22,0	22,0
1241533	R1A11M9113-1515_A	15	M22X1.5	36,0	21,0	32,5	19,0	27,0	27,0
1243857	R1A11M9113-1818_A	18	M26X1.5	40,0	23,5	35,5	24,0	32,0	32,0
1243858	R1A11M9113-2222_A	22	M30X2	44,0	27,5	38,5	27,0	36,0	36,0
1243859	R1A11M9113-2828_A	28	M36X2	47,0	30,5	41,5	36,0	41,0	41,0
1243860	R1A11M9113-3535_A	35	M45X2	56,0	34,5	51,0	41,0	50,0	50,0
1241092	R1A11M9113-4242_A	42	M52X2	63,0	40,0	60,0	50,0	60,0	60,0

// R1A12M9123**90° adjustable elbow connector****DIN 24° Male - Female pre-assembled****Heavy Series**

Item Code	Product Code	OD1	F1	Q1 (mm)	Q2 (mm)	Q3 (mm)	CH (mm)	CH2 (mm)
1206278	R1A12M9123-0606	6	M14X1.5	23,0	16,0	27,0	12,0	17,0
1205732	R1A12M9123-0808	8	M16X1.5	24,0	17,0	27,5	14,0	19,0
1205563	R1A12M9123-1010	10	M18X1.5	25,0	17,5	30,0	17,0	22,0
1205757	R1A12M9123-1212	12	M20X1.5	29,0	21,5	31,0	17,0	24,0
1205733	R1A12M9123-1414	14	M22X1.5	30,0	22,0	35,0	19,0	27,0
1205532	R1A12M9123-1616	16	M24X1.5	33,0	24,5	36,5	24,0	30,0
1205533	R1A12M9123-2020	20	M30X2	37,0	26,5	44,5	27,0	36,0
1205534	R1A12M9123-2525	25	M36X2	42,0	30,0	50,0	36,0	46,0
1205734	R1A12M9123-3030	30	M42X2	49,0	35,5	55,0	41,0	50,0
1206412	R1A12M9123-3838	38	M52X2	57,0	41,0	64,5	50,0	60,0

// R1E12M9123

90° adjustable elbow connector
DIN 24° Male - Female pre-assembled
Heavy Series
Complete



Item Code	Product Code	OD1	F2	Q1 (mm)	Q2 (mm)	Q3 (mm)	CH (mm)	CH1 (mm)	CH2 (mm)
1244214	R1A12M9123-0606_A	6	M14X1.5	31,0	16,0	27,0	12,0	17,0	17,0
1244215	R1A12M9123-0808_A	8	M16X1.5	32,0	17,0	27,5	14,0	19,0	19,0
1244216	R1A12M9123-1010_A	10	M18X1.5	34,0	17,5	30,0	17,0	22,0	22,0
1244217	R1A12M9123-1212_A	12	M20X1.5	38,0	21,5	31,0	17,0	24,0	24,0
1244218	R1A12M9123-1414_A	14	M22X1.5	40,0	22,0	35,0	19,0	27,0	27,0
1244219	R1A12M9123-1616_A	16	M24X1.5	43,0	24,5	36,5	24,0	30,0	30,0
1244220	R1A12M9123-2020_A	20	M30X2	48,0	26,5	44,5	27,0	36,0	36,0
1244221	R1A12M9123-2525_A	25	M36X2	54,0	30,0	50,0	36,0	46,0	46,0
1244222	R1A12M9123-3030_A	30	M42X2	62,0	35,5	55,0	41,0	50,0	50,0
1244223	R1A12M9123-3838_A	38	M52X2	72,0	41,0	64,5	50,0	60,0	60,0

// R1A11M9152

90° adjustable elbow connector
DIN 24° Male - Female with O-Ring
Light Series



Item Code	Product Code	OD1	F1	Q1 (mm)	Q2 (mm)	Q3 (mm)	CH (mm)	CH2 (mm)
1211396	R1A11M9152-0606	6	M12X1.5	20,0	12,0	26,0	12,0	14,0
1207070	R1A11M9152-0808	8	M14X1.5	21,0	14,0	27,5	12,0	17,0
1244462	R1A11M9152-1010	10	M16X1.5	22,5	15,0	29,0	17,0	19,0
1206852	R1A11M9152-1212	12	M18X1.5	24,0	17,0	29,5	17,0	22,0
1206853	R1A11M9152-1515	15	M22X1.5	28,0	21,0	32,5	19,0	27,0
1206854	R1A11M9152-1818	18	M26X1.5	31,0	23,5	35,5	24,0	32,0
1206855	R1A11M9152-2222	22	M30X2	35,0	27,5	38,5	27,0	36,0
1211397	R1A11M9152-2828	28	M36X2	38,0	30,5	41,5	36,0	41,0
1208087	R1A11M9152-3535	35	M45X2	45,0	34,5	51,0	41,0	50,0
1211398	R1A11M9152-4242	42	M52X2	51,0	40,0	56,0	50,0	60,0

Design and dimensions shown may be changed without prior notice

// R1E11M9152**90° adjustable elbow connector****DIN 24° Male - Female with O-Ring****Light Series****Complete**

Item Code	Product Code	OD1	F2	Q1 (mm)	Q2 (mm)	Q3 (mm)	CH (mm)	CH1 (mm)	CH2 (mm)
1243869	R1A11M9152-0606_A	6	M12X1.5	27,0	12,0	26,0	12,0	14,0	14,0
1243870	R1A11M9152-0808_A	8	M14X1.5	29,0	14,0	27,5	12,0	17,0	17,0
1206816	R1A11M9152-1010_A	10	M16X1.5	30,0	15,0	29,0	17,0	19,0	19,0
1243871	R1A11M9152-1212_A	12	M18X1.5	32,0	17,0	29,5	17,0	22,0	22,0
1243872	R1A11M9152-1515_A	15	M22X1.5	36,0	21,0	32,5	19,0	27,0	27,0
1243873	R1A11M9152-1818_A	18	M26X1.5	40,0	23,5	35,5	24,0	32,0	32,0
1243874	R1A11M9152-2222_A	22	M30X2	44,0	27,5	38,5	27,0	36,0	36,0
1243875	R1A11M9152-2828_A	28	M36X2	47,0	30,5	41,5	36,0	41,0	41,0
1243876	R1A11M9152-3535_A	35	M45X2	56,0	34,5	51,0	41,0	50,0	50,0
1243877	R1A11M9152-4242_A	42	M52X2	63,0	40,0	56,0	50,0	60,0	60,0

// R1A12M9162**90° adjustable elbow connector****DIN 24° Male - Female with O-Ring****Heavy Series**

Item Code	Product Code	Product Code	OD1	F1	Q1 (mm)	Q2 (mm)	Q3 (mm)	CH (mm)	CH2 (mm)
1208183	R1A12M9162-0606	R1A12M9162-0606	6	M14X1.5	23,0	16,0	27,0	12,0	17,0
1206824	R1A12M9162-0808	R1A12M9162-0808	8	M16X1.5	24,0	17,0	27,5	14,0	19,0
1211456	R1A12M9162-1010	R1A12M9162-1010	10	M18X1.5	25,0	17,5	30,0	17,0	22,0
1206823	R1A12M9162-1212	R1A12M9162-1212	12	M20X1.5	29,0	21,5	31,0	17,0	24,0
1208186	R1A12M9162-1414	R1A12M9162-1414	14	M22X1.5	30,0	22,0	35,0	19,0	27,0
1207073	R1A12M9162-1616	R1A12M9162-1616	16	M24X1.5	33,0	24,5	36,5	24,0	30,0
1207074	R1A12M9162-2020	R1A12M9162-2020	20	M30X2	37,0	26,5	44,5	27,0	36,0
1241699	R1A12M9162-2525	R1A12M9162-2525	25	M36X2	42,0	30,0	50,0	36,0	46,0
1207076	R1A12M9162-3030	R1A12M9162-3030	30	M42X2	49,0	35,5	55,0	41,0	50,0
1211457	R1A12M9162-3838	R1A12M9162-3838	38	M52X2	57,0	41,0	63,0	50,0	60,0

// R1E12M9162

90° adjustable elbow connector
DIN 24° Male - Female with O-Ring
Heavy Series
Complete



Item Code	Product Code	OD1	F2	Q1 (mm)	Q2 (mm)	Q3 (mm)	CH (mm)	CH1 (mm)	CH2 (mm)
1244233	R1A12M9162-0606_A	6	M14X1.5	31,0	16,0	27,0	12,0	17,0	17,0
1244234	R1A12M9162-0808_A	8	M16X1.5	32,0	17,0	27,5	14,0	19,0	19,0
1244235	R1A12M9162-1010_A	10	M18X1.5	34,0	17,5	30,0	17,0	22,0	22,0
1244236	R1A12M9162-1212_A	12	M20X1.5	38,0	21,5	31,0	17,0	24,0	24,0
1244237	R1A12M9162-1414_A	14	M22X1.5	40,0	22,0	35,0	19,0	27,0	27,0
1244238	R1A12M9162-1616_A	16	M24X1.5	43,0	24,5	36,5	24,0	30,0	30,0
1244239	R1A12M9162-2020_A	20	M30X2	48,0	26,5	44,5	27,0	36,0	36,0
1207075	R1A12M9162-2525_A	25	M36X2	54,0	30,0	50,0	36,0	46,0	46,0
1244240	R1A12M9162-3030_A	30	M42X2	62,0	35,5	55,0	41,0	50,0	50,0
1244241	R1A12M9162-3838_A	38	M52X2	72,0	41,0	63,0	50,0	60,0	60,0

// R1A11MT113

Branch Tee adjustable elbow connector
DIN 24° Male - Female pre-assembled
Light Series



Item Code	OD1	F3	Q1 (mm)	Q2 (mm)	Q3 (mm)	CH (mm)	CH3 (mm)
1204222	6	M12X1.5	19,0	12,0	26,0	12,0	14,0
1205477	8	M14X1.5	21,0	14,0	27,5	12,0	17,0
1205735	10	M16X1.5	22,0	15,0	29,0	14,0	19,0
1205522	12	M18X1.5	24,0	17,0	29,5	17,0	22,0
1205676	15	M22X1.5	28,0	21,0	32,5	19,0	27,0
1205758	18	M26X1.5	31,0	23,5	35,5	24,0	32,0
1205736	22	M30X2	35,0	27,5	38,5	27,0	36,0
1206279	28	M36X2	38,0	30,5	41,5	36,0	41,0
1206584	35	M45X2	45,0	34,5	51,0	41,0	50,0
1206585	42	M52X2	51,0	40,0	60,0	50,0	60,0

Design and dimensions shown may be changed without prior notice

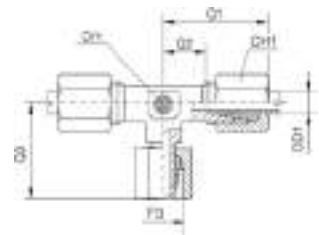
// R1E11MT113**Branch Tee adjustable elbow connector****DIN 24° Male - Female pre-assembled****Light Series****Complete**

Item Code	Product Code	OD1	F3	Q1 (mm)	Q2 (mm)	Q3 (mm)	CH (mm)	CH1 (mm)	CH3 (mm)
1243974	R1A11MT113-0606_A	6	M12X1.5	27,0	12,0	26,0	12,0	14,0	14,0
1241539	R1A11MT113-0808_A	8	M14X1.5	29,0	14,0	27,5	12,0	17,0	17,0
1241540	R1A11MT113-1010_A	10	M16X1.5	30,0	15,0	29,0	14,0	19,0	19,0
1241541	R1A11MT113-1212_A	12	M18X1.5	32,0	17,0	29,5	17,0	22,0	22,0
1243975	R1A11MT113-1515_A	15	M22X1.5	36,0	21,0	32,5	19,0	27,0	27,0
1243976	R1A11MT113-1818_A	18	M26X1.5	40,0	23,5	35,5	24,0	32,0	32,0
1243977	R1A11MT113-2222_A	22	M30X2	44,0	27,5	38,5	27,0	36,0	36,0
1243978	R1A11MT113-2828_A	28	M36X2	47,0	30,5	41,5	36,0	41,0	41,0
1243979	R1A11MT113-3535_A	35	M45X2	56,0	34,5	51,0	41,0	50,0	50,0
1243980	R1A11MT113-4242_A	42	M52X2	63,0	40,0	60,0	50,0	60,0	60,0

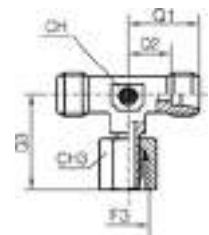
// R1A12MT123**Branch Tee adjustable elbow connector****DIN 24° Male - Female pre-assembled****Heavy Series**

Item Code	Product Code	OD1	F3	Q1 (mm)	Q2 (mm)	Q3 (mm)	CH (mm)	CH3 (mm)
1206355	R1A12MT123-0606	6	M14X1.5	23,0	16,0	27,0	12,0	17,0
1206373	R1A12MT123-0808	8	M16X1.5	24,0	17,0	27,5	14,0	19,0
1205581	R1A12MT123-1010	10	M18X1.5	25,0	17,5	30,0	17,0	22,0
1205737	R1A12MT123-1212	12	M20X1.5	29,0	21,5	31,0	17,0	24,0
1206280	R1A12MT123-1414	14	M22X1.5	30,0	22,0	35,0	19,0	27,0
1205738	R1A12MT123-1616	16	M24X1.5	33,0	24,5	36,5	24,0	30,0
1205739	R1A12MT123-2020	20	M30X2	37,0	26,5	44,5	27,0	36,0
1206281	R1A12MT123-2525	25	M36X2	42,0	30,0	50,0	36,0	46,0
1206297	R1A12MT123-3030	30	M42X2	49,0	35,5	55,0	41,0	50,0
1206587	R1A12MT123-3838	38	M52X2	57,0	41,0	64,5	50,0	60,0

// R1E12MT123

Branch Tee adjustable elbow connector
DIN 24° Male - Female pre-assembled
Heavy Series
Complete

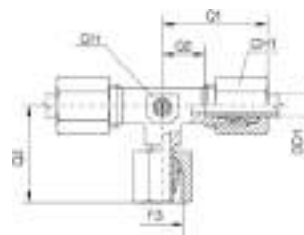

Item Code	Product Code	OD1	F3	Q1 (mm)	Q2 (mm)	Q3 (mm)	CH (mm)	CH1 (mm)	CH3 (mm)
1244340	R1A12MT123-0606_A	6	M14X1.5	31,0	16,0	27,0	12,0	17,0	17,0
1244341	R1A12MT123-0808_A	8	M16X1.5	32,0	17,0	27,5	14,0	19,0	19,0
1244342	R1A12MT123-1010_A	10	M18X1.5	34,0	17,5	30,0	17,0	22,0	22,0
1244343	R1A12MT123-1212_A	12	M20X1.5	38,0	21,5	31,0	17,0	24,0	24,0
1244344	R1A12MT123-1414_A	14	M22X1.5	40,0	22,0	35,0	19,0	27,0	27,0
1244345	R1A12MT123-1616_A	16	M24X1.5	43,0	24,5	36,5	24,0	30,0	30,0
1244346	R1A12MT123-2020_A	20	M30X2	48,0	26,5	44,5	27,0	36,0	36,0
1244347	R1A12MT123-2525_A	25	M36X2	54,0	30,0	50,0	36,0	46,0	46,0
1244348	R1A12MT123-3030_A	30	M42X2	62,0	35,5	55,0	41,0	50,0	50,0
1244349	R1A12MT123-3838_A	38	M52X2	72,0	41,0	64,5	50,0	60,0	60,0

// R1A11MT152

Branch Tee adjustable elbow connector
DIN 24° Male - Female with O-Ring
Light Series

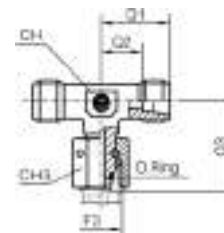

Item Code	Product Code	OD1	F3	Q1 (mm)	Q2 (mm)	Q3 (mm)	CH (mm)	CH3 (mm)
1211350	R1A11MT152-0606	6	M12X1.5	20,0	12,0	26,0	12,0	14,0
1208058	R1A11MT152-0808	8	M14X1.5	21,0	14,0	27,5	12,0	17,0
1206856	R1A11MT152-1010	10	M16X1.5	22,5	15,0	29,0	14,0	19,0
1210689	R1A11MT152-1212	12	M18X1.5	24,0	17,0	29,5	19,0	22,0
1208059	R1A11MT152-1515	15	M22X1.5	28,0	21,0	32,5	19,0	27,0
1208060	R1A11MT152-1818	18	M26X1.5	31,0	23,5	35,5	24,0	32,0
1211351	R1A11MT152-2222	22	M30X2	35,0	27,5	38,5	27,0	36,0
1211352	R1A11MT152-2828	28	M36X2	38,0	30,5	41,5	36,0	41,0
1208061	R1A11MT152-3535	35	M45X2	45,0	34,5	51,0	41,0	50,0
1211353	R1A11MT152-4242	42	M52X2	51,0	40,0	56,0	50,0	60,0

Design and dimensions shown may be changed without prior notice

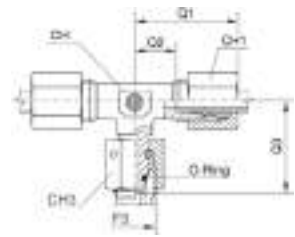
// R1E11MT152**Branch Tee adjustable elbow connector****DIN 24° Male - Female with O-Ring****Light Series****Complete**

Item Code	Product Code	OD1	F3	Q1 (mm)	Q2 (mm)	Q3 (mm)	CH (mm)	CH1 (mm)	CH3 (mm)
1243986	R1A11MT152-0606_A	6	M12X1.5	27,0	12,0	26,0	12,0	14,0	14,0
1243987	R1A11MT152-0808_A	8	M14X1.5	29,0	14,0	27,5	12,0	17,0	17,0
1243988	R1A11MT152-1010_A	10	M16X1.5	30,0	15,0	29,0	14,0	19,0	19,0
1241143	R1A11MT152-1212_A	12	M18X1.5	32,0	17,0	29,5	19,0	22,0	22,0
1243989	R1A11MT152-1515_A	15	M22X1.5	36,0	21,0	32,5	19,0	27,0	27,0
1243990	R1A11MT152-1818_A	18	M26X1.5	40,0	23,5	35,5	24,0	32,0	32,0
1243991	R1A11MT152-2222_A	22	M30X2	44,0	27,5	38,5	27,0	36,0	36,0
1243992	R1A11MT152-2828_A	28	M36X2	47,0	30,5	41,5	36,0	41,0	41,0
1243993	R1A11MT152-3535_A	35	M45X2	56,0	34,5	51,0	41,0	50,0	50,0
1243994	R1A11MT152-4242_A	42	M52X2	63,0	40,0	56,0	50,0	60,0	60,0

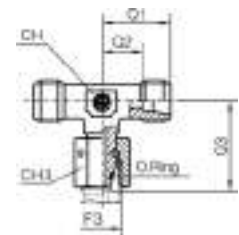
// R1A12MT162**Branch Tee adjustable elbow connector****DIN 24° Male - Female with O-Ring****Heavy series**

Item Code	Product Code	OD1	F3	Q1 (mm)	Q2 (mm)	Q3 (mm)	CH (mm)	CH3 (mm)
1211404	R1A12MT162-0606	6	M14X1.5	23,0	16,0	27,0	12,0	17,0
1211405	R1A12MT162-0808	8	M16X1.5	24,0	17,0	27,5	14,0	19,0
1208196	R1A12MT162-1010	10	M18X1.5	25,0	17,5	30,0	17,0	22,0
1208197	R1A12MT162-1212	12	M20X1.5	29,0	21,5	31,0	17,0	24,0
1211406	R1A12MT162-1414	14	M22X1.5	30,0	22,0	35,0	19,0	27,0
1207470	R1A12MT162-1616	16	M24X1.5	33,0	24,5	36,5	24,0	30,0
1211407	R1A12MT162-2020	20	M30X2	37,0	26,5	44,5	27,0	36,0
1211408	R1A12MT162-2525	25	M36X2	42,0	30,0	50,0	36,0	46,0
1211409	R1A12MT162-3030	30	M42X2	49,0	35,5	55,0	41,0	50,0
1211410	R1A12MT162-3838	38	M52X2	57,0	41,0	63,0	50,0	60,0

// R1E12MT162

Branch Tee adjustable elbow connector
DIN 24° Male - Female with O-Ring
Heavy Series
Complete

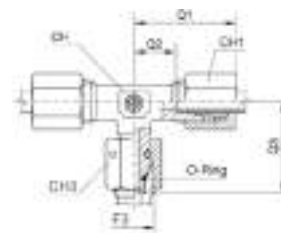

Item Code	Product Code	OD1	F3	Q1 (mm)	Q2 (mm)	Q3 (mm)	CH (mm)	CH1 (mm)	CH3 (mm)
1244360	R1A12MT162-0606_A	6	M14X1.5	31,0	16,0	27,0	12,0	17,0	17,0
1244361	R1A12MT162-0808_A	8	M16X1.5	32,0	17,0	27,5	14,0	19,0	19,0
1244362	R1A12MT162-1010_A	10	M18X1.5	34,0	17,5	30,0	17,0	22,0	22,0
1244363	R1A12MT162-1212_A	12	M20X1.5	38,0	21,5	31,0	17,0	24,0	24,0
1244364	R1A12MT162-1414_A	14	M22X1.5	40,0	22,0	35,0	19,0	27,0	27,0
1244365	R1A12MT162-1616_A	16	M24X1.5	43,0	24,5	36,5	24,0	30,0	30,0
1244366	R1A12MT162-2020_A	20	M30X2	48,0	26,5	44,5	27,0	36,0	36,0
1244367	R1A12MT162-2525_A	25	M36X2	54,0	30,0	50,0	36,0	46,0	46,0
1244368	R1A12MT162-3030_A	30	M42X2	62,0	35,5	55,0	41,0	50,0	50,0
1244369	R1A12MT162-3838_A	38	M52X2	72,0	41,0	63,0	50,0	60,0	60,0

// R1A11ML113

Run Tee adjustable elbow connector
DIN 24° Male - Female pre-assembled
Light Series



Item Code	Product Code	OD1	F1	Q1 (mm)	Q2 (mm)	Q3 (mm)	CH (mm)	CH2 (mm)
1205478	R1A11ML113-0606	6	M12X1.5	19,0	12,0	26,0	12,0	14,0
1205479	R1A11ML113-0808	8	M14X1.5	21,0	14,0	27,5	12,0	17,0
1205677	R1A11ML113-1010	10	M16X1.5	22,0	15,0	29,0	14,0	19,0
1242248	R1A11ML113-1212	12	M18X1.5	24,0	17,0	29,5	17,0	22,0
1204221	R1A11ML113-1515	15	M22X1.5	28,0	21,0	32,5	19,0	27,0
1205529	R1A11ML113-1818	18	M26X1.5	31,0	23,5	35,5	24,0	32,0
1205759	R1A11ML113-2222	22	M30X2	35,0	27,5	38,5	27,0	36,0
1206072	R1A11ML113-2828	28	M36X2	38,0	30,5	41,5	36,0	41,0
1206129	R1A11ML113-3535	35	M45X2	45,0	34,5	51,0	41,0	50,0
1206586	R1A11ML113-4242	42	M52X2	51,0	40,0	60,0	50,0	60,0

Design and dimensions shown may be changed without prior notice

// R1E11ML113

Run Tee adjustable elbow connector
DIN 24° Male - Female pre-assembled
Light Series
Complete

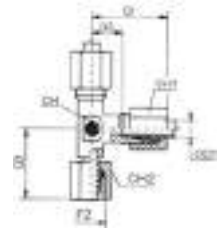

Item Code	Product Code	OD1	F2	Q1 (mm)	Q2 (mm)	Q3 (mm)	CH (mm)	CH1 (mm)	CH2 (mm)
1241964	R1A11ML113-0606_A	6	M12X1.5	27,0	12,0	26,0	12,0	14,0	14,0
1241535	R1A11ML113-0808_A	8	M14X1.5	29,0	14,0	27,5	12,0	17,0	17,0
1241702	R1A11ML113-1010_A	10	M16X1.5	30,0	15,0	29,0	14,0	19,0	19,0
1241536	R1A11ML113-1212_A	12	M18X1.5	32,0	17,0	29,5	17,0	22,0	22,0
1241537	R1A11ML113-1515_A	15	M22X1.5	36,0	21,0	32,5	19,0	27,0	27,0
1243939	R1A11ML113-1818_A	18	M26X1.5	40,0	23,5	35,5	24,0	32,0	32,0
1243940	R1A11ML113-2222_A	22	M30X2	44,0	27,5	38,5	27,0	36,0	36,0
1243941	R1A11ML113-2828_A	28	M36X2	47,0	30,5	41,5	36,0	41,0	41,0
1243942	R1A11ML113-3535_A	35	M45X2	56,0	34,5	51,0	41,0	50,0	50,0
1243943	R1A11ML113-4242_A	42	M52X2	63,0	40,0	60,0	50,0	60,0	60,0

// R1A12ML123

Run Tee adjustable elbow connector
DIN 24° Male - Female pre-assembled
Heavy series

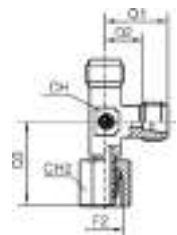

Item Code	Product Code	OD1	F2	Q1 (mm)	Q2 (mm)	Q3 (mm)	CH (mm)	CH2 (mm)
1206354	R1A12ML123-0606	6	M14X1.5	23,0	16,0	27,0	12,0	17,0
1206367	R1A12ML123-0808	8	M16X1.5	24,0	17,0	27,5	14,0	19,0
1205580	R1A12ML123-1010	10	M18X1.5	25,0	17,5	30,0	17,0	22,0
1206179	R1A12ML123-1212	12	M20X1.5	29,0	21,5	31,0	17,0	24,0
1206130	R1A12ML123-1414	14	M22X1.5	30,0	22,0	35,0	19,0	27,0
1206010	R1A12ML123-1616	16	M24X1.5	33,0	24,5	36,5	24,0	30,0
1205678	R1A12ML123-2020	20	M30X2	37,0	26,5	44,5	27,0	36,0
1206255	R1A12ML123-2525	25	M36X2	42,0	30,0	50,0	36,0	46,0
1205574	R1A12ML123-3030	30	M42X2	49,0	35,5	55,0	41,0	50,0
1206588	R1A12ML123-3838	38	M52X2	57,0	41,0	64,5	50,0	60,0

// R1E12ML123

Run Tee adjustable elbow connector
DIN 24° Male - Female pre-assembled
Heavy Series
Complete

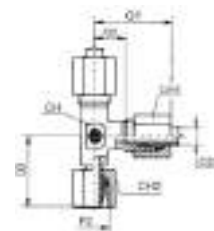

Item Code	Product Code	OD1	F2	Q1 (mm)	Q2 (mm)	Q3 (mm)	CH (mm)	CH1 (mm)	CH2 (mm)
1244302	R1A12ML123-0606_A	6	M14X1.5	31,0	16,0	27,0	12,0	17,0	17,0
1244303	R1A12ML123-0808_A	8	M16X1.5	32,0	17,0	27,5	14,0	19,0	19,0
1244304	R1A12ML123-1010_A	10	M18X1.5	34,0	17,5	30,0	17,0	22,0	22,0
1244305	R1A12ML123-1212_A	12	M20X1.5	38,0	21,5	31,0	17,0	24,0	24,0
1244306	R1A12ML123-1414_A	14	M22X1.5	40,0	22,0	35,0	19,0	27,0	27,0
1244307	R1A12ML123-1616_A	16	M24X1.5	43,0	24,5	36,5	24,0	30,0	30,0
1244308	R1A12ML123-2020_A	20	M30X2	48,0	26,5	44,5	27,0	36,0	36,0
1244309	R1A12ML123-2525_A	25	M36X2	54,0	30,0	50,0	36,0	46,0	46,0
1244310	R1A12ML123-3030_A	30	M42X2	62,0	35,5	55,0	41,0	50,0	50,0
1244311	R1A12ML123-3838_A	38	M52X2	72,0	41,0	64,5	50,0	60,0	60,0

// R1A11ML152

Run Tee adjustable elbow connector
DIN 24° Male - Female with O-Ring
Light Series



Item Code	Product Code	OD1	F2	Q1 (mm)	Q2 (mm)	Q3 (mm)	Q4 (mm)	CH (mm)	CH2 (mm)
1211347	R1A11ML152-0606	6	M12X1.5	20,0	12,0	26,0	46,0	12,0	14,0
1208088	R1A11ML152-0808	8	M14X1.5	21,0	14,0	27,5	48,5	12,0	17,0
1206813	R1A11ML152-1010	10	M16X1.5	22,5	15,0	29,0	51,5	14,0	19,0
1206889	R1A11ML152-1212	12	M18X1.5	24,0	17,0	29,5	53,5	17,0	22,0
1207522	R1A11ML152-1515	15	M22X1.5	28,0	21,0	32,5	60,5	19,0	27,0
1208089	R1A11ML152-1818	18	M26X1.5	31,0	23,5	35,5	66,5	24,0	32,0
1207518	R1A11ML152-2222	22	M30X2	35,0	27,5	38,5	73,5	27,0	36,0
1208090	R1A11ML152-2828	28	M36X2	38,0	30,5	41,5	79,5	36,0	41,0
1211348	R1A11ML152-3535	35	M45X2	45,0	34,5	51,0	96,0	41,0	50,0
1211349	R1A11ML152-4242	42	M52X2	51,0	40,0	56,0	107,0	50,0	60,0

Design and dimensions shown may be changed without prior notice

// R1E11ML152**Run Tee adjustable elbow connector****DIN 24° Male - Female with O-Ring****Light Series****Complete**

Item Code	Product Code	OD1	F2	Q1 (mm)	Q2 (mm)	Q3 (mm)	Q4 (mm)	CH (mm)	CH1 (mm)	CH2 (mm)
1243944	R1A11ML152-0606_A	6	M12X1.5	27,0	12,0	26,0	53,0	12,0	14,0	14,0
1243945	R1A11ML152-0808_A	8	M14X1.5	29,0	14,0	27,5	56,0	12,0	17,0	17,0
1243946	R1A11ML152-1010_A	10	M16X1.5	30,0	15,0	29,0	59,0	14,0	19,0	19,0
1243947	R1A11ML152-1212_A	12	M18X1.5	32,0	17,0	29,5	61,0	17,0	22,0	22,0
1243948	R1A11ML152-1515_A	15	M22X1.5	36,0	21,0	32,5	69,0	19,0	27,0	27,0
1243949	R1A11ML152-1818_A	18	M26X1.5	40,0	23,5	35,5	75,0	24,0	32,0	32,0
1243950	R1A11ML152-2222_A	22	M30X2	44,0	27,5	38,5	82,0	27,0	36,0	36,0
1243951	R1A11ML152-2828_A	28	M36X2	47,0	30,5	41,5	89,0	36,0	41,0	41,0
1243952	R1A11ML152-3535_A	35	M45X2	56,0	34,5	51,0	107,0	41,0	50,0	50,0
1243953	R1A11ML152-4242_A	42	M52X2	63,0	40,0	56,0	119,0	50,0	60,0	60,0

// R1A12ML162**Run Tee adjustable elbow connector****DIN 24° Male - Female with O-Ring****Heavy Series**

Item Code	Product Code	OD1	F2	Q1 (mm)	Q2 (mm)	Q3 (mm)	Q4 (mm)	CH (mm)	CH2 (mm)
1211400	R1A12ML162-0606	6	M14X1.5	23,0	16,0	27,0	50,0	12,0	17,0
1207087	R1A12ML162-0808	8	M16X1.5	24,0	17,0	27,5	51,5	14,0	19,0
1211401	R1A12ML162-1010	10	M18X1.5	25,0	17,5	30,0	55,0	17,0	22,0
1208190	R1A12ML162-1212	12	M20X1.5	29,0	21,5	31,0	60,0	17,0	24,0
1206883	R1A12ML162-1414	14	M22X1.5	30,0	22,0	35,0	65,0	19,0	27,0
1211402	R1A12ML162-1616	16	M24X1.5	33,0	24,5	36,5	69,5	24,0	30,0
1208193	R1A12ML162-2020	20	M30X2	37,0	26,5	44,5	81,5	27,0	36,0
1207086	R1A12ML162-2525	25	M36X2	42,0	30,0	50,0	92,0	36,0	46,0
1211403	R1A12ML162-3030	30	M42X2	49,0	35,5	55,0	104,0	41,0	50,0
1208194	R1A12ML162-3838	38	M52X2	57,0	41,0	63,0	120,0	50,0	60,0

// R1E12ML162

Run Tee adjustable elbow connector

DIN 24° Male - Female with O-Ring

Heavy Series

Complete



Item Code	Product Code	OD1	F2	Q1 (mm)	Q2 (mm)	Q3 (mm)	Q4 (mm)	CH (mm)	CH1 (mm)	CH2 (mm)
1244312	R1A12ML162-0606_A	6	M14X1.5	31,0	16,0	27,0	58,0	12,0	17,0	17,0
1244313	R1A12ML162-0808_A	8	M16X1.5	32,0	17,0	27,5	59,0	14,0	19,0	19,0
1244314	R1A12ML162-1010_A	10	M18X1.5	34,0	17,5	30,0	64,0	17,0	22,0	22,0
1244315	R1A12ML162-1212_A	12	M20X1.5	38,0	21,5	31,0	69,0	17,0	24,0	24,0
1244316	R1A12ML162-1414_A	14	M22X1.5	40,0	22,0	35,0	75,0	19,0	27,0	27,0
1244317	R1A12ML162-1616_A	16	M24X1.5	43,0	24,5	36,5	79,0	24,0	30,0	30,0
1244318	R1A12ML162-2020_A	20	M30X2	48,0	26,5	44,5	93,0	27,0	36,0	36,0
1244319	R1A12ML162-2525_A	25	M36X2	54,0	30,0	50,0	104,0	36,0	46,0	46,0
1244320	R1A12ML162-3030_A	30	M42X2	62,0	35,5	55,0	117,0	41,0	50,0	50,0
1244321	R1A12ML162-3838_A	38	M52X2	72,0	41,0	63,0	135,0	50,0	60,0	60,0

Design and dimensions shown may be changed without prior notice

// BULKHEAD

// R1A11T111M

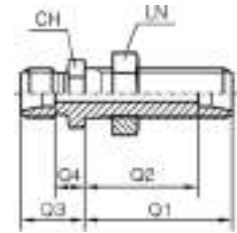
Straight union DIN 24° Bulkhead
Light Series

Item Code	Product Code	OD1	F1	Q1 (mm)	Q2 (mm)	Q3 (mm)	Q4 (mm)	CH (mm)	LN (mm)
1206125	R1A11T111M-0606	6	M12X1.5	34,0	27,0	14,0	7,0	17,0	17,0
1205545	R1A11T111M-0808	8	M14X1.5	34,0	27,0	15,0	8,0	19,0	19,0
1206243	R1A11T111M-1010	10	M16X1.5	35,0	28,0	17,0	10,0	22,0	22,0
1205892	R1A11T111M-1212	12	M18X1.5	36,0	29,0	17,0	10,0	24,0	24,0
1205679	R1A11T111M-1515	15	M22X1.5	38,0	31,0	19,0	12,0	27,0	30,0
1206126	R1A11T111M-1818	18	M26X1.5	40,0	32,5	19,0	13,5	32,0	36,0
1205540	R1A11T111M-2222	22	M30X2	42,0	34,5	24,0	16,5	36,0	41,0
1206071	R1A11T111M-2828	28	M36X2	43,0	35,5	26,0	18,5	41,0	46,0
1206244	R1A11T111M-3535	35	M45X2	47,0	36,5	29,0	18,5	50,0	55,0
1207043	R1A11T111M-4242	42	M52X2	47,0	36,0	30,0	19,0	60,0	65,0

// R1E11T111M

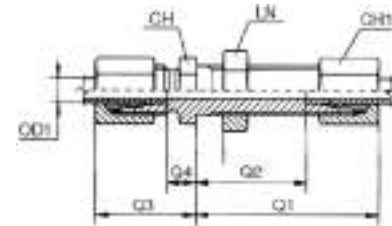
Straight union DIN 24° Bulkhead
Light Series
Complete

Item Code	Product Code	OD1	F1	Q1 (mm)	Q2 (mm)	Q3 (mm)	Q4 (mm)	CH (mm)	CH1 (mm)	LN (mm)
1244014	R1A11T111M-0606_A	6	M12X1.5	42,0	27,0	22,0	7,0	17,0	14,0	17,0
1240816	R1A11T111M-0808_A	8	M14X1.5	42,0	27,0	23,0	8,0	19,0	17,0	19,0
1240818	R1A11T111M-1010_A	10	M16X1.5	43,0	28,0	25,0	10,0	22,0	19,0	22,0
1241544	R1A11T111M-1212_A	12	M18X1.5	44,0	29,0	25,0	10,0	24,0	22,0	24,0
1241546	R1A11T111M-1515_A	15	M22X1.5	46,0	31,0	27,0	12,0	27,0	27,0	30,0
1244015	R1A11T111M-1818_A	18	M26X1.5	49,0	32,5	30,0	13,5	32,0	32,0	36,0
1244016	R1A11T111M-2222_A	22	M30X2	51,0	34,5	33,0	16,5	36,0	36,0	41,0
1244017	R1A11T111M-2828_A	28	M36X2	52,0	35,5	35,0	18,5	41,0	41,0	46,0
1244018	R1A11T111M-3535_A	35	M45X2	58,0	36,5	40,0	18,5	50,0	50,0	55,0
1244019	R1A11T111M-4242_A	42	M52X2	59,0	36,0	42,0	19,0	60,0	60,0	65,0

// R1A12T112M

**Straight union DIN 24° Bulkhead
Heavy Series**

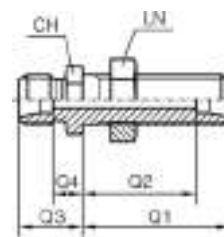

Item Code	Product Code	OD1	F1	Q1 (mm)	Q2 (mm)	Q3 (mm)	Q4 (mm)	CH (mm)	LN (mm)
1206358	R1A12T112M-0606	6	M14X1.5	36,0	29,0	19,0	12,0	19,0	19,0
1205969	R1A12T112M-0808	8	M16X1.5	36,0	29,0	20,0	13,0	22,0	22,0
1206245	R1A12T112M-1010	10	M18X1.5	37,0	29,5	22,0	14,5	24,0	24,0
1206247	R1A12T112M-1212	12	M20X1.5	38,0	30,5	22,0	14,5	27,0	27,0
1206246	R1A12T112M-1414	14	M22X1.5	40,0	32,0	25,0	17,0	30,0	30,0
1205970	R1A12T112M-1616	16	M24X1.5	40,0	31,5	25,0	16,5	32,0	32,0
1205957	R1A12T112M-2020	20	M30X2	44,0	33,5	28,0	17,5	41,0	41,0
1206127	R1A12T112M-2525	25	M36X2	47,0	35,0	32,0	20,0	46,0	46,0
1205575	R1A12T112M-3030	30	M42X2	51,0	37,5	35,0	21,5	50,0	50,0
1206417	R1A12T112M-3838	38	M52X2	53,0	37,0	38,0	22,0	65,0	65,0

// R1E12T112M

**Straight union DIN 24° Bulkhead
Heavy Series
Complete**

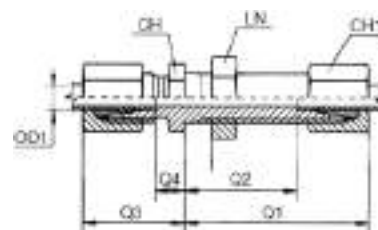

Item Code	Product Code	OD1	F1	Q1 (mm)	Q2 (mm)	Q3 (mm)	Q4 (mm)	CH (mm)	CH1 (mm)	LN (mm)
1244389	R1A12T112M-0606_A	6	M14X1.5	44,0	29,0	27,0	12,0	19,0	17,0	19,0
1244390	R1A12T112M-0808_A	8	M16X1.5	44,0	29,0	28,0	13,0	22,0	19,0	22,0
1244391	R1A12T112M-1010_A	10	M18X1.5	46,0	29,5	31,0	14,5	24,0	22,0	24,0
1244392	R1A12T112M-1212_A	12	M20X1.5	47,0	30,5	31,0	14,5	27,0	24,0	27,0
1244393	R1A12T112M-1414_A	14	M22X1.5	50,0	32,0	35,0	17,0	30,0	27,0	30,0
1243660	R1A12T112M-1616_A	16	M24X1.5	50,0	31,5	35,0	16,5	32,0	30,0	32,0
1244394	R1A12T112M-2020_A	20	M30X2	55,0	33,5	39,0	17,5	41,0	36,0	41,0
1244395	R1A12T112M-2525_A	25	M36X2	59,0	35,0	44,0	20,0	46,0	46,0	46,0
1244396	R1A12T112M-3030_A	30	M42X2	64,0	37,5	48,0	21,5	50,0	50,0	50,0
1244397	R1A12T112M-3838_A	38	M52X2	68,0	37,0	53,0	22,0	65,0	60,0	65,0

Design and dimensions shown may be changed without prior notice

// R1A11T911M

90° union DIN 24° Bulkhead

Light Series

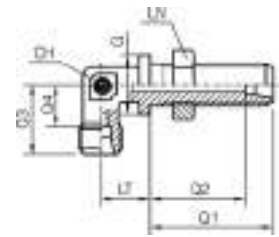

Item Code	Product Code	OD1	F1	Q1 (mm)	Q2 (mm)	Q3 (mm)	Q4 (mm)	LT (mm)	G (mm)	CH (mm)	LN (mm)
1206248	R1A11T911M-0606	6	M12X1.5	34,0	27,0	19,0	12,0	14,0	17,0	12,0	17,0
1206249	R1A11T911M-0808	8	M14X1.5	34,0	27,0	21,0	14,0	17,0	19,0	12,0	19,0
1206250	R1A11T911M-1010	10	M16X1.5	35,0	28,0	22,0	15,0	18,0	22,0	14,0	22,0
1206251	R1A11T911M-1212	12	M18X1.5	36,0	29,0	24,0	17,0	20,0	24,0	17,0	24,0
1205686	R1A11T911M-1515	15	M22X1.5	38,0	31,0	28,0	21,0	23,0	27,0	19,0	30,0
1206252	R1A11T911M-1818	18	M26X1.5	40,0	32,5	31,0	23,5	24,0	32,0	24,0	36,0
1206253	R1A11T911M-2222	22	M30X2	42,0	34,5	35,0	27,5	30,0	36,0	27,0	41,0
1206357	R1A11T911M-2828	28	M36X2	43,0	35,5	38,0	30,5	34,0	42,0	36,0	46,0
1206254	R1A11T911M-3535	35	M45X2	47,0	36,5	45,0	34,5	39,0	50,0	41,0	55,0
1206820	R1A11T911M-4242	42	M52X2	47,0	36,0	51,0	40,0	43,0	60,0	50,0	65,0

// R1E11T911M

90° union DIN 24° Bulkhead

Light Series

Complete

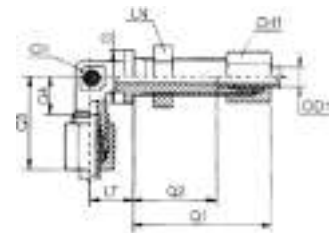

Item Code	Product Code	OD1	F1	Q1 (mm)	Q2 (mm)	Q3 (mm)	Q4 (mm)	LT (mm)	G (mm)	CH (mm)	CH1 (mm)	LN (mm)
1241547	R1A11T911M-0606_A	6	M12X1.5	42,0	27,0	27,0	12,0	14,0	17,0	12,0	14,0	17,0
1241548	R1A11T911M-0808_A	8	M14X1.5	42,0	27,0	29,0	14,0	17,0	19,0	12,0	17,0	19,0
1241549	R1A11T911M-1010_A	10	M16X1.5	43,0	28,0	30,0	15,0	18,0	22,0	14,0	19,0	22,0
1244020	R1A11T911M-1212_A	12	M18X1.5	44,0	29,0	32,0	17,0	20,0	24,0	17,0	22,0	24,0
1244021	R1A11T911M-1515_A	15	M22X1.5	46,0	31,0	36,0	21,0	23,0	27,0	19,0	27,0	30,0
1244022	R1A11T911M-1818_A	18	M26X1.5	49,0	32,5	40,0	23,5	24,0	32,0	24,0	32,0	36,0
1244023	R1A11T911M-2222_A	22	M30X2	51,0	34,5	44,0	27,5	30,0	36,0	27,0	36,0	41,0
1244024	R1A11T911M-2828_A	28	M36X2	52,0	35,5	47,0	30,5	34,0	42,0	36,0	41,0	46,0
1244025	R1A11T911M-3535_A	35	M45X2	58,0	36,5	56,0	34,5	39,0	50,0	41,0	50,0	55,0
1244026	R1A11T911M-4242_A	42	M52X2	59,0	36,0	63,0	40,0	43,0	60,0	50,0	60,0	65,0

// R1A12T912M

**90° union DIN 24° Bulkhead
Heavy Series**

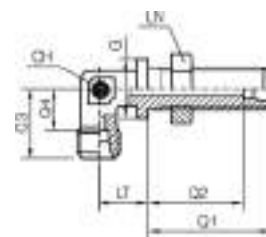

Item Code	Product Code	OD1	F1	Q1 (mm)	Q2 (mm)	Q3 (mm)	Q4 (mm)	LT (mm)	G (mm)	CH (mm)	LN (mm)
1207147	R1A12T912M-0606	6	M14X1.5	36,0	29,0	23,0	16,0	17,0	19,0	12,0	19,0
1206374	R1A12T912M-0808	8	M16X1.5	36,0	29,0	24,0	17,0	18,0	22,0	14,0	22,0
1206256	R1A12T912M-1010	10	M18X1.5	37,0	29,5	25,0	17,5	20,0	24,0	17,0	24,0
1206260	R1A12T912M-1212	12	M20X1.5	38,0	30,5	29,0	21,5	21,0	27,0	17,0	27,0
1206257	R1A12T912M-1414	14	M22X1.5	40,0	32,0	30,0	22,0	23,0	27,0	19,0	30,0
1206258	R1A12T912M-1616	16	M24X1.5	40,0	31,5	33,0	24,5	24,0	30,0	24,0	32,0
1206259	R1A12T912M-2020	20	M30X2	44,0	33,5	37,0	26,5	30,0	36,0	27,0	41,0
1206261	R1A12T912M-2525	25	M36X2	47,0	35,0	42,0	30,0	34,0	42,0	36,0	46,0
1207148	R1A12T912M-3030	30	M42X2	51,0	37,5	49,0	35,5	39,0	50,0	41,0	50,0
1207149	R1A12T912M-3838	38	M52X2	53,0	37,0	57,0	41,0	43,0	60,0	50,0	65,0

// R1E12T912M

**90° union DIN 24° Bulkhead
Heavy Series
Complete**

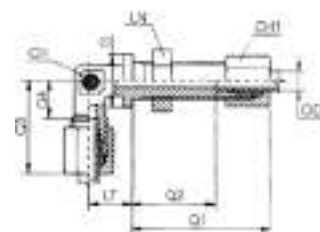

Item Code	Product Code	OD1	F1	Q1 (mm)	Q2 (mm)	Q3 (mm)	Q4 (mm)	LT (mm)	G (mm)	CH (mm)	CH1 (mm)	LN (mm)
1244398	R1A12T912M-0606_A	6	M14X1.5	44,0	29,0	31,0	16,0	17,0	19,0	12,0	17,0	19,0
1244399	R1A12T912M-0808_A	8	M16X1.5	44,0	29,0	32,0	17,0	18,0	22,0	14,0	19,0	22,0
1244400	R1A12T912M-1010_A	10	M18X1.5	46,0	29,5	34,0	17,5	20,0	24,0	17,0	22,0	24,0
1244401	R1A12T912M-1212_A	12	M20X1.5	47,0	30,5	38,0	21,5	21,0	27,0	17,0	24,0	27,0
1244402	R1A12T912M-1414_A	14	M22X1.5	50,0	32,0	40,0	22,0	23,0	27,0	19,0	27,0	30,0
1243661	R1A12T912M-1616_A	16	M24X1.5	50,0	31,5	43,0	24,5	24,0	30,0	24,0	30,0	32,0
1244403	R1A12T912M-2020_A	20	M30X2	55,0	33,5	48,0	26,5	30,0	36,0	27,0	36,0	41,0
1244404	R1A12T912M-2525_A	25	M36X2	59,0	35,0	54,0	30,0	34,0	42,0	36,0	46,0	46,0
1244405	R1A12T912M-3030_A	30	M42X2	64,0	37,5	62,0	35,5	39,0	50,0	41,0	50,0	50,0
1244406	R1A12T912M-3838_A	38	M52X2	68,0	37,0	72,0	41,0	43,0	60,0	50,0	60,0	65,0

Design and dimensions shown may be changed without prior notice

// METRIC

// R1A11M150M

Straight connector

DIN 24° Male - Metric cylindric Male

Light Series

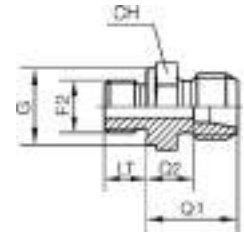

Item Code	Product Code	OD1	F2	Q1 (mm)	Q2 (mm)	LT (mm)	G (mm)	CH (mm)
1205809	R1A11M150M-0610	6	M10X1.0	15,5	8,5	8,0	14,0	14,0
1205684	R1A11M150M-0812	8	M12X1.5	17,0	10,0	12,0	17,0	17,0
1205556	R1A11M150M-1014	10	M14X1.5	18,0	11,0	12,0	19,0	19,0
1203520	R1A11M150M-1216	12	M16X1.5	19,5	12,5	12,0	21,0	22,0
1205557	R1A11M150M-1518	15	M18X1.5	20,5	14,0	14,0	23,0	24,0
1206006	R1A11M150M-1822	18	M22X1.5	22,0	14,5	14,0	27,0	27,0
1205812	R1A11M150M-2226	22	M26X1.5	24,0	16,5	16,0	31,0	32,0
1206534	R1A11M150M-2833	28	M33X2.0	25,0	17,5	18,0	39,0	41,0
1208162	R1A11M150M-3542	35	M42X2	28,0	17,5	20,0	49,0	50,0
1207814	R1A11M150M-4248	42	M48X2.0	30,0	19,0	22,0	55,0	55,0

// R1E11M150M

Straight connector

DIN 24° Male - Metric cylindric Male

Light Series

Complete

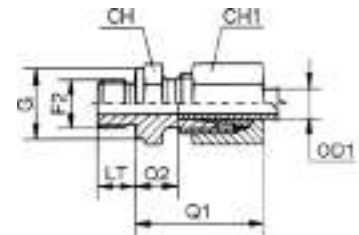

Item Code	Product Code	OD1	F2	Q1 (mm)	Q2 (mm)	LT (mm)	G (mm)	CH (mm)	CH1 (mm)
1243830	R1A11M150M-0610_A	6	M10X1.0	23,0	8,5	8,0	14,0	14,0	14,0
1243831	R1A11M150M-0812_A	8	M12X1.5	25,0	10,0	12,0	17,0	17,0	17,0
1243832	R1A11M150M-1014_A	10	M14X1.5	26,0	11,0	12,0	19,0	19,0	19,0
1243833	R1A11M150M-1216_A	12	M16X1.5	27,0	12,5	12,0	21,0	22,0	22,0
1243834	R1A11M150M-1518_A	15	M18X1.5	29,0	14,0	14,0	23,0	24,0	27,0
1243835	R1A11M150M-1822_A	18	M22X1.5	31,0	14,5	14,0	27,0	27,0	32,0
1243836	R1A11M150M-2226_A	22	M26X1.5	33,0	16,5	16,0	31,0	32,0	36,0
1243837	R1A11M150M-2833_A	28	M33X2.0	34,0	17,5	18,0	39,0	41,0	41,0
1243838	R1A11M150M-3542_A	35	M42X2	39,0	17,5	20,0	49,0	50,0	50,0
1243839	R1A11M150M-4248_A	42	M48X2.0	42,0	19,0	22,0	55,0	55,0	60,0

// R1A12M150M

Straight connector

DIN 24° Male - Metric cylindric Male

Heavy Series

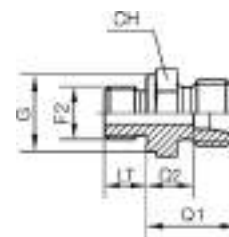

Item Code	Product Code	OD1	F2	Q1 (mm)	Q2 (mm)	LT (mm)	G (mm)	CH (mm)
1206225	R1A12M150M-0612	6	M12X1.5	20,0	13,0	12,0	17,0	17,0
1206226	R1A12M150M-0814	8	M14X1.5	22,0	15,0	12,0	19,0	19,0
1205971	R1A12M150M-1016	10	M16X1.5	22,5	15,0	12,0	21,0	22,0
1205813	R1A12M150M-1218	12	M18X1.5	24,5	17,0	12,0	23,0	24,0
1205814	R1A12M150M-1420	14	M20X1.5	27,0	19,0	14,0	25,0	27,0
1205815	R1A12M150M-1622	16	M22X1.5	27,0	18,5	14,0	27,0	27,0
1205816	R1A12M150M-2027	20	M27X2	31,0	20,5	16,0	32,0	32,0
1205817	R1A12M150M-2533	25	M33X2.0	35,0	23,0	18,0	39,0	41,0
1211293	R1A12M150M-3042	30	M42X2	37,0	23,5	20,0	49,0	50,0
1211294	R1A12M150M-3848	38	M48X2.0	42,0	26,0	22,0	55,0	55,0

// R1E12M150M

Straight connector

DIN 24° Male - Metric cylindric Male

Heavy Series

Complete

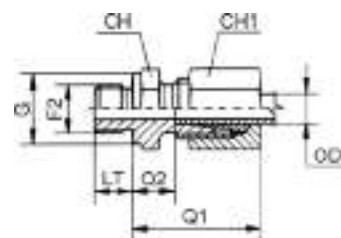

Item Code	Product Code	OD1	F2	Q1 (mm)	Q2 (mm)	LT (mm)	G (mm)	CH (mm)	CH1 (mm)
1244185	R1A12M150M-0612_A	6	M12X1.5	28,0	13,0	12,0	17,0	17,0	17,0
1244186	R1A12M150M-0814_A	8	M14X1.5	30,0	15,0	12,0	19,0	19,0	19,0
1244187	R1A12M150M-1016_A	10	M16X1.5	31,0	15,0	12,0	21,0	22,0	22,0
1244188	R1A12M150M-1218_A	12	M18X1.5	33,0	17,0	12,0	23,0	24,0	24,0
1244189	R1A12M150M-1420_A	14	M20X1.5	37,0	19,0	14,0	25,0	27,0	27,0
1244190	R1A12M150M-1622_A	16	M22X1.5	37,0	18,5	14,0	27,0	27,0	30,0
1244191	R1A12M150M-2027_A	20	M27X2	42,0	20,5	16,0	32,0	32,0	36,0
1244192	R1A12M150M-2533_A	25	M33X2.0	47,0	23,0	18,0	39,0	41,0	46,0
1244193	R1A12M150M-3042_A	30	M42X2	50,0	23,5	20,0	49,0	50,0	50,0
1244194	R1A12M150M-3848_A	38	M48X2.0	57,0	26,0	22,0	55,0	55,0	60,0

Design and dimensions shown may be changed without prior notice

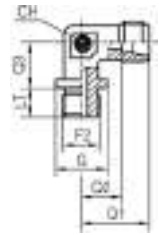
// R1A11M950M**90° elbow connector****DIN 24° Male - Metric cylindric Male****Light Series**

Item Code	Product Code	OD1	F2	Q1 (mm)	Q2 (mm)	Q3 (mm)	LT (mm)	G (mm)	CH (mm)
1211163	R1A11M950M-2226	22	M26X1.5	35,0	27,5	26,0	16,0	32,0	27,0
1211164	R1A11M950M-2833	28	M33X2.0	38,0	30,5	30,0	18,0	39,0	36,0
1211165	R1A11M950M-3542	35	M42X2	45,0	34,5	34,0	20,0	49,0	41,0
1211166	R1A11M950M-4248	42	M48X2.0	51,0	40,0	39,0	22,0	55,0	50,0

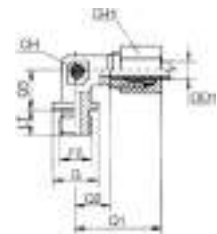
// R1E11M950M**90° elbow connector****DIN 24° Male - Metric cylindric Male****Light Series****Complete**

Item Code	Product Code	OD1	F2	Q1 (mm)	Q2 (mm)	Q3 (mm)	LT (mm)	G (mm)	CH (mm)	CH1 (mm)
1243878	R1A11M950M-2226_A	22	M26X1.5	44,0	27,5	26,0	16,0	32,0	27,0	36,0
1243879	R1A11M950M-2833_A	28	M33X2.0	47,0	30,5	30,0	18,0	39,0	36,0	41,0
1243880	R1A11M950M-3542_A	35	M42X2	56,0	34,5	34,0	20,0	49,0	41,0	50,0
1243881	R1A11M950M-4248_A	42	M48X2.0	63,0	40,0	39,0	22,0	55,0	50,0	60,0

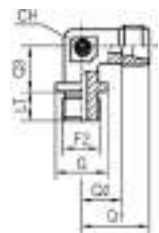
// R1A12M950M**90° elbow connector****DIN 24° Male - Metric cylindric Male****Heavy Series**

Item Code	Product Code	OD1	F2	Q1 (mm)	Q2 (mm)	Q3 (mm)	LT (mm)	G (mm)	CH (mm)
1211320	R1A12M950M-2027	20	M27X2	37,0	26,5	26,0	16,0	32,0	27,0
1211321	R1A12M950M-2533	25	M33X2.0	42,0	31,0	30,0	18,0	39,0	36,0
1211322	R1A12M950M-3042	30	M42X2	49,0	35,5	34,0	20,0	49,0	41,0
1211323	R1A12M950M-3848	38	M48X2.0	57,0	41,0	39,0	22,0	55,0	50,0

// R1E12M950M

90° elbow connector

DIN 24° Male - Metric cylindric Male

Heavy Series

Complete

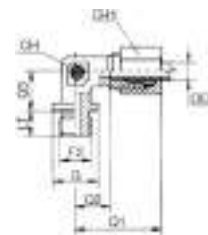

Item Code	Product Code	OD1	F2	Q1 (mm)	Q2 (mm)	Q3 (mm)	LT (mm)	G (mm)	CH (mm)	CH1 (mm)
1244242	R1A12M950M-2027_A	20	M27X2	48,0	26,5	26,0	16,0	32,0	27,0	36,0
1244243	R1A12M950M-2533_A	25	M33X2.0	54,0	31,0	30,0	18,0	39,0	36,0	46,0
1244244	R1A12M950M-3042_A	30	M42X2	62,0	35,5	34,0	20,0	49,0	41,0	50,0
1244245	R1A12M950M-3848_A	38	M48X2.0	72,0	41,0	39,0	22,0	55,0	50,0	60,0

// R1A11M452Q

45° adjustable elbow connector

DIN 24° Male - Metric Male with O-Ring and retaining ring

Light Series



Item Code	Product Code	OD1	F2	Q1 (mm)	Q2 (mm)	Q3 (mm)	LT (mm)	G (mm)	CH (mm)	LN (mm)
1244877	R1A11M452Q-0610	6	M10X1.0	21,0	14,0	20,0	7,5	15,0	14,0	14,0
1244878	R1A11M452Q-0812	8	M12X1.5	23,0	16,0	22,5	9,5	18,0	14,0	17,0
1239701	R1A11M452Q-1014	10	M14X1.5	24,0	17,0	25,5	9,5	20,0	19,0	19,0
1244879	R1A11M452Q-1216	12	M16X1.5	26,0	19,0	26,0	10,0	23,0	19,0	22,0
1244880	R1A11M452Q-1518	15	M18X1.5	28,0	21,0	30,0	11,0	25,0	22,0	24,0
1244881	R1A11M452Q-1822	18	M22X1.5	31,5	24,0	34,0	11,0	28,0	27,0	27,0
1244882	R1A11M452Q-2227	22	M27X2	35,5	28,0	36,0	13,5	33,0	33,0	32,0
1244883	R1A11M452Q-2833	28	M33X2.0	38,5	31,0	40,5	13,5	41,0	41,0	41,0
1244884	R1A11M452Q-3542	35	M42X2	48,5	38,0	48,5	13,5	51,0	48,0	50,0
1244885	R1A11M452Q-4248	42	M48X2.0	49,0	38,0	50,0	15,0	56,0	48,0	55,0

Design and dimensions shown may be changed without prior notice

// R1E11M452Q**45° adjustable elbow connector****DIN 24° Male - Metric Male with O-Ring and retaining ring****Light Series****Complete**

Item Code	Product Code	OD1	F2	Q1 (mm)	Q2 (mm)	Q3 (mm)	LT (mm)	G (mm)	CH (mm)	CH1 (mm)	LN (mm)
1244949	R1A11M452Q-0610_A	6	M10X1.0	29,0	14,0	20,0	7,5	15,0	14,0	14,0	14,0
1244950	R1A11M452Q-0812_A	8	M12X1.5	31,0	16,0	22,5	9,5	18,0	14,0	17,0	17,0
1244951	R1A11M452Q-1014_A	10	M14X1.5	32,0	17,0	25,5	9,5	20,0	19,0	19,0	19,0
1244952	R1A11M452Q-1216_A	12	M16X1.5	34,0	19,0	26,0	10,0	23,0	19,0	22,0	22,0
1244953	R1A11M452Q-1518_A	15	M18X1.5	36,0	21,0	30,0	11,0	25,0	22,0	27,0	24,0
1244954	R1A11M452Q-1822_A	18	M22X1.5	40,0	24,0	34,0	11,0	28,0	27,0	32,0	27,0
1244955	R1A11M452Q-2227_A	22	M27X2	44,0	28,0	36,0	13,5	33,0	33,0	36,0	32,0
1244956	R1A11M452Q-2833_A	28	M33X2.0	47,0	31,0	40,5	13,5	41,0	41,0	41,0	41,0
1244957	R1A11M452Q-3542_A	35	M42X2	59,0	38,0	48,5	13,5	51,0	48,0	50,0	50,0
1244958	R1A11M452Q-4248_A	42	M48X2.0	61,0	38,0	50,0	15,0	56,0	48,0	60,0	55,0

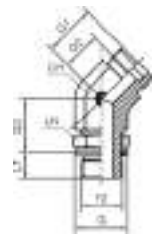
// R1A12M452Q**45° adjustable elbow connector****DIN 24° Male - Metric Male with O-Ring and retaining ring****Heavy Series**

Item Code	Product Code	OD1	F2	Q1 (mm)	Q2 (mm)	Q3 (mm)	LT (mm)	G (mm)	CH (mm)	LN (mm)
1244903	R1A12M452Q-0612	6	M12X1.5	22,5	15,5	23,5	9,5	18,0	14,0	17,0
1244904	R1A12M452Q-0814	8	M14X1.5	25,0	18,0	26,5	9,5	20,0	19,0	19,0
1237052	R1A12M452Q-1016	10	M16X1.5	25,5	18,0	27,0	11,0	23,0	19,0	22,0
1244905	R1A12M452Q-1218	12	M18X1.5	29,5	22,0	30,5	12,5	25,0	22,0	24,0
1244906	R1A12M452Q-1622	16	M22X1.5	33,5	25,0	37,0	13,0	28,0	27,0	27,0
1237053	R1A12M452Q-2027	20	M27X2	38,5	28,0	39,5	14,0	33,0	33,0	32,0
1244907	R1A12M452Q-2533	25	M33X2.0	42,5	30,5	43,0	14,0	41,0	41,0	41,0
1244908	R1A12M452Q-3042	30	M42X2	49,5	36,0	52,0	16,0	51,0	48,0	50,0
1244909	R1A12M452Q-3848	38	M48X2.0	50,0	34,0	51,0	18,0	56,0	48,0	55,0

// R1E12M452Q

45° adjustable elbow connector

DIN 24° Male - Metric Male with O-Ring and retaining ring

Heavy Series

Complete



Item Code	Product Code	OD1	F2	Q1 (mm)	Q2 (mm)	Q3 (mm)	LT (mm)	G (mm)	CH (mm)	CH1 (mm)	LN (mm)
1245017	R1A12M452Q-0612_A	6	M12X1.5	30,5	15,5	23,5	9,5	18,0	14,0	17,0	17,0
1245018	R1A12M452Q-0814_A	8	M14X1.5	33,0	18,0	26,5	9,5	20,0	19,0	19,0	19,0
1245019	R1A12M452Q-1016_A	10	M16X1.5	34,0	18,0	27,0	11,0	23,0	19,0	22,0	22,0
1245020	R1A12M452Q-1218_A	12	M18X1.5	38,0	22,0	30,5	12,5	25,0	22,0	24,0	24,0
1245021	R1A12M452Q-1622_A	16	M22X1.5	43,0	25,0	37,0	13,0	28,0	27,0	30,0	27,0
1245022	R1A12M452Q-2027_A	20	M27X2	49,0	28,0	39,5	14,0	33,0	33,0	36,0	32,0
1245023	R1A12M452Q-2533_A	25	M33X2.0	54,5	30,5	43,0	14,0	41,0	41,0	46,0	41,0
1245024	R1A12M452Q-3042_A	30	M42X2	62,0	36,0	52,0	16,0	51,0	48,0	50,0	50,0
1245025	R1A12M452Q-3848_A	38	M48X2.0	65,0	34,0	51,0	18,0	56,0	48,0	60,0	55,0

// R1A11M952Q

90° adjustable elbow connector

DIN 24° Male - Metric Male with O-Ring and retaining ring

Light Series

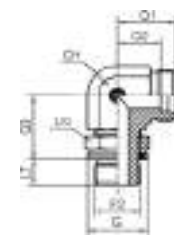

Item Code	Product Code	OD1	F2	Q1 (mm)	Q2 (mm)	Q3 (mm)	LT (mm)	G (mm)	CH (mm)	LN (mm)
1242471	R1A11M952Q-0610	6	M10X1.0	21,0	14,0	20,0	7,5	15,0	14,0	14,0
1231361	R1A11M952Q-0812	8	M12X1.5	23,0	16,0	22,5	9,5	18,0	14,0	17,0
1231362	R1A11M952Q-1014	10	M14X1.5	24,0	17,0	25,5	9,5	20,0	19,0	19,0
1242472	R1A11M952Q-1216	12	M16X1.5	26,0	19,0	26,0	10,0	23,0	19,0	22,0
1231363	R1A11M952Q-1518	15	M18X1.5	28,0	21,0	30,0	11,0	25,0	22,0	24,0
1242473	R1A11M952Q-1822	18	M22X1.5	31,5	24,0	34,0	11,0	28,0	27,0	27,0
1237041	R1A11M952Q-2227	22	M27X2	35,5	28,0	36,0	13,5	33,0	33,0	32,0
1231364	R1A11M952Q-2833	28	M33X2.0	38,5	31,0	40,5	13,5	41,0	41,0	41,0
1231365	R1A11M952Q-3542	35	M42X2	48,5	38,0	48,5	13,5	51,0	48,0	50,0
1242474	R1A11M952Q-4248	42	M48X2.0	49,0	38,0	50,0	15,0	56,0	48,0	55,0

Design and dimensions shown may be changed without prior notice

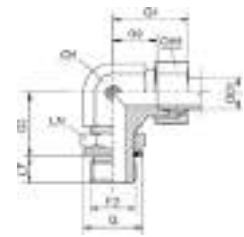
// R1E11M952Q**90° adjustable elbow connector****DIN 24° Male - Metric Male with O-Ring and retaining ring****Light Series****Complete**

Item Code	Product Code	OD1	F2	Q1 (mm)	Q2 (mm)	Q3 (mm)	LT (mm)	G (mm)	CH (mm)	CH1 (mm)	LN (mm)
1243882	R1A11M952Q-0610_A	6	M10X1.0	29,0	14,0	20,0	7,5	15,0	14,0	14,0	14,0
1243883	R1A11M952Q-0812_A	8	M12X1.5	31,0	16,0	22,5	9,5	18,0	14,0	17,0	17,0
1243884	R1A11M952Q-1014_A	10	M14X1.5	32,0	17,0	25,5	9,5	20,0	19,0	19,0	19,0
1243885	R1A11M952Q-1216_A	12	M16X1.5	34,0	19,0	26,0	10,0	23,0	19,0	22,0	22,0
1243886	R1A11M952Q-1518_A	15	M18X1.5	36,0	21,0	30,0	11,0	25,0	22,0	27,0	24,0
1243887	R1A11M952Q-1822_A	18	M22X1.5	40,0	24,0	34,0	11,0	28,0	27,0	32,0	27,0
1243888	R1A11M952Q-2227_A	22	M27X2	44,0	28,0	36,0	13,5	33,0	33,0	36,0	32,0
1243889	R1A11M952Q-2833_A	28	M33X2.0	47,0	31,0	40,5	13,5	41,0	41,0	41,0	41,0
1243890	R1A11M952Q-3542_A	35	M42X2	59,0	38,0	48,5	13,5	51,0	48,0	50,0	50,0
1243891	R1A11M952Q-4248_A	42	M48X2.0	61,0	38,0	50,0	15,0	56,0	48,0	60,0	55,0

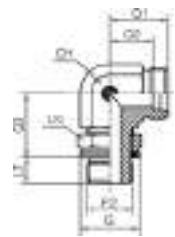
// R1A12M952Q**90° adjustable elbow connector****DIN 24° Male - Metric Male with O-Ring and retaining ring****Heavy Series**

Item Code	Product Code	OD1	F2	Q1 (mm)	Q2 (mm)	Q3 (mm)	LT (mm)	G (mm)	CH (mm)	LN (mm)
1231379	R1A12M952Q-0612	6	M12X1.5	22,5	15,5	23,5	9,5	18,0	14,0	17,0
1216243	R1A12M952Q-0814	8	M14X1.5	25,0	18,0	26,5	9,5	20,0	19,0	19,0
1242475	R1A12M952Q-1016	10	M16X1.5	25,5	18,0	27,0	11,0	23,0	19,0	22,0
1242476	R1A12M952Q-1218	12	M18X1.5	29,5	22,0	30,5	12,5	25,0	22,0	24,0
1242477	R1A12M952Q-1622	16	M22X1.5	33,5	25,0	37,0	13,0	28,0	27,0	27,0
1211329	R1A12M952Q-2027	20	M27X2	38,5	28,0	39,5	14,0	33,0	33,0	32,0
1242478	R1A12M952Q-2533	25	M33X2.0	42,5	30,5	43,0	14,0	41,0	41,0	41,0
1242479	R1A12M952Q-3042	30	M42X2	49,5	36,0	52,0	16,0	51,0	48,0	50,0
1242480	R1A12M952Q-3848	38	M48X2.0	50,0	34,0	51,0	18,0	56,0	48,0	55,0

// R1E12M952Q

90° adjustable elbow connector

DIN 24° Male - Metric Male with O-Ring and retaining ring

Heavy Series

Complete

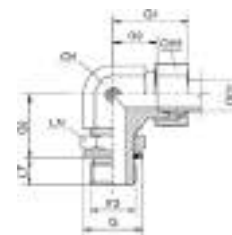

Item Code	Product Code	OD1	F2	Q1 (mm)	Q2 (mm)	Q3 (mm)	LT (mm)	G (mm)	CH (mm)	CH1 (mm)	LN (mm)
1244246	R1A12M952Q-0612_A	6	M12X1.5	30,5	15,5	23,5	9,5	18,0	14,0	17,0	17,0
1244247	R1A12M952Q-0814_A	8	M14X1.5	33,0	18,0	26,5	9,5	20,0	19,0	19,0	19,0
1244248	R1A12M952Q-1016_A	10	M16X1.5	34,0	18,0	27,0	11,0	23,0	19,0	22,0	22,0
1244249	R1A12M952Q-1218_A	12	M18X1.5	38,0	22,0	30,5	12,5	25,0	22,0	24,0	24,0
1244250	R1A12M952Q-1622_A	16	M22X1.5	43,0	25,0	37,0	13,0	28,0	27,0	30,0	27,0
1244251	R1A12M952Q-2027_A	20	M27X2	49,0	28,0	39,5	14,0	33,0	33,0	36,0	32,0
1244252	R1A12M952Q-2533_A	25	M33X2.0	54,5	30,5	43,0	14,0	41,0	41,0	46,0	41,0
1244253	R1A12M952Q-3042_A	30	M42X2	62,0	36,0	52,0	16,0	51,0	48,0	50,0	50,0
1244254	R1A12M952Q-3848_A	38	M48X2.0	65,0	34,0	51,0	18,0	56,0	48,0	60,0	55,0

// R1A11MT52Q

Branch Tee adjustable elbow connector

DIN 24° Male - Metric Male with O-Ring and retaining ring

Light Series

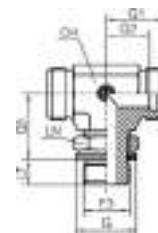

Item Code	Product Code	OD1	F3	Q1 (mm)	Q2 (mm)	Q3 (mm)	LT (mm)	G (mm)	CH (mm)	CH1 (mm)	LN (mm)
1242481	R1A11MT52Q-0610	6	M10X1.0	21,0	14,0	20,0	7,5	15,0	14,0	14,0	14,0
1242482	R1A11MT52Q-0812	8	M12X1.5	23,0	16,0	22,5	9,5	18,0	14,0	17,0	17,0
1242483	R1A11MT52Q-1014	10	M14X1.5	24,0	17,0	25,5	9,5	20,0	19,0	19,0	19,0
1242484	R1A11MT52Q-1216	12	M16X1.5	26,0	19,0	26,0	10,0	23,0	19,0	22,0	22,0
1242485	R1A11MT52Q-1518	15	M18X1.5	28,0	21,0	30,0	11,0	25,0	22,0	24,0	24,0
1242486	R1A11MT52Q-1822	18	M22X1.5	31,5	24,0	34,0	11,0	28,0	27,0	27,0	27,0
1242487	R1A11MT52Q-2227	22	M27X2	35,5	28,0	36,0	13,5	33,0	33,0	33,0	32,0
1242488	R1A11MT52Q-2833	28	M33X2.0	38,5	31,0	40,5	13,5	41,0	41,0	41,0	41,0
1242489	R1A11MT52Q-3542	35	M42X2	48,5	38,0	48,5	13,5	51,0	48,0	48,0	50,0
1237043	R1A11MT52Q-4248	42	M48X2.0	49,0	38,0	50,0	15,0	56,0	48,0	48,0	55,0

Design and dimensions shown may be changed without prior notice

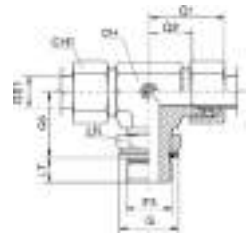
// R1E11MT52Q**Branch Tee adjustable elbow connector****DIN 24° Male - Metric Male with O-Ring and retaining ring****Light Series****Complete**

Item Code	Product Code	OD1	F3	Q1 (mm)	Q2 (mm)	Q3 (mm)	LT (mm)	G (mm)	CH (mm)	CH1 (mm)	LN (mm)
1243995	R1A11MT52Q-0610_A	6	M10X1.0	29,0	14,0	20,0	7,5	15,0	14,0	14,0	14,0
1243996	R1A11MT52Q-0812_A	8	M12X1.5	31,0	16,0	22,5	9,5	18,0	14,0	17,0	17,0
1243997	R1A11MT52Q-1014_A	10	M14X1.5	32,0	17,0	25,5	9,5	20,0	19,0	19,0	19,0
1243998	R1A11MT52Q-1216_A	12	M16X1.5	34,0	19,0	26,0	10,0	23,0	19,0	22,0	22,0
1243999	R1A11MT52Q-1518_A	15	M18X1.5	36,0	21,0	30,0	11,0	25,0	22,0	27,0	24,0
1244000	R1A11MT52Q-1822_A	18	M22X1.5	40,0	24,0	34,0	11,0	28,0	27,0	32,0	27,0
1244001	R1A11MT52Q-2227_A	22	M27X2	44,0	28,0	36,0	13,5	33,0	33,0	36,0	32,0
1244002	R1A11MT52Q-2833_A	28	M33X2.0	47,0	31,0	40,5	13,5	41,0	41,0	41,0	41,0
1244003	R1A11MT52Q-3542_A	35	M42X2	59,0	38,0	48,5	13,5	51,0	48,0	50,0	50,0
1244004	R1A11MT52Q-4248_A	42	M48X2.0	61,0	38,0	50,0	15,0	56,0	48,0	60,0	55,0

// R1A12MT52Q**Branch Tee adjustable elbow connector****DIN 24° Male - Metric Male with O-Ring and retaining ring****Heavy Series**

Item Code	Product Code	OD1	F3	Q1 (mm)	Q2 (mm)	Q3 (mm)	LT (mm)	G (mm)	CH (mm)	LN (mm)
1242490	R1A12MT52Q-0612	6	M12X1.5	22,5	15,5	23,5	9,5	18,0	14,0	17,0
1242491	R1A12MT52Q-0814	8	M14X1.5	25,0	18,0	26,5	9,5	20,0	19,0	19,0
1242492	R1A12MT52Q-1016	10	M16X1.5	25,5	18,0	27,0	11,0	23,0	19,0	22,0
1242493	R1A12MT52Q-1218	12	M18X1.5	29,5	22,0	30,5	12,5	25,0	22,0	24,0
1242494	R1A12MT52Q-1622	16	M22X1.5	33,5	25,0	37,0	13,0	28,0	27,0	27,0
1242495	R1A12MT52Q-2027	20	M27X2	38,5	28,0	39,5	14,0	33,0	33,0	32,0
1242496	R1A12MT52Q-2533	25	M33X2.0	42,5	30,5	43,0	14,0	41,0	41,0	41,0
1242497	R1A12MT52Q-3042	30	M42X2	49,5	36,0	52,0	16,0	51,0	48,0	50,0
1242498	R1A12MT52Q-3848	38	M48X2.0	50,0	34,0	51,0	18,0	56,0	48,0	55,0

// R1E12MT52Q

Branch Tee adjustable elbow connector

DIN 24° Male - Metric Male with O-Ring and retaining ring

Heavy Series

Complete



Item Code	Product Code	OD1	F3	Q1 (mm)	Q2 (mm)	Q3 (mm)	LT (mm)	G (mm)	CH (mm)	CH1 (mm)	LN (mm)
1244370	R1A12MT52Q-0612_A	6	M12X1.5	30,5	15,5	23,5	9,5	18,0	14,0	17,0	17,0
1244371	R1A12MT52Q-0814_A	8	M14X1.5	33,0	18,0	26,5	9,5	20,0	19,0	19,0	19,0
1244372	R1A12MT52Q-1016_A	10	M16X1.5	34,0	18,0	27,0	11,0	23,0	19,0	22,0	22,0
1244373	R1A12MT52Q-1218_A	12	M18X1.5	38,0	22,0	30,5	12,5	25,0	22,0	24,0	24,0
1244374	R1A12MT52Q-1622_A	16	M22X1.5	43,0	25,0	37,0	13,0	28,0	27,0	30,0	27,0
1244375	R1A12MT52Q-2027_A	20	M27X2	49,0	28,0	39,5	14,0	33,0	33,0	36,0	32,0
1244376	R1A12MT52Q-2533_A	25	M33X2.0	54,5	30,5	43,0	14,0	41,0	41,0	46,0	41,0
1244377	R1A12MT52Q-3042_A	30	M42X2	62,0	36,0	52,0	16,0	51,0	48,0	50,0	50,0
1244378	R1A12MT52Q-3848_A	38	M48X2.0	65,0	34,0	51,0	18,0	56,0	48,0	60,0	55,0

// R1A11ML52Q

Run Tee adjustable elbow connector

DIN 24° Male - Metric Male with O-Ring and retaining ring

Light Series

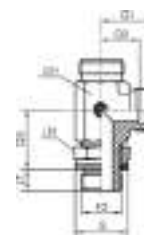

Item Code	Product Code	OD1	F2	Q1 (mm)	Q2 (mm)	Q3 (mm)	LT (mm)	G (mm)	CH (mm)	LN (mm)
1242499	R1A11ML52Q-0610	6	M10X1.0	21,0	14,0	20,0	7,5	15,0	14,0	14,0
1242500	R1A11ML52Q-0812	8	M12X1.5	23,0	16,0	22,5	9,5	18,0	14,0	17,0
1242501	R1A11ML52Q-1014	10	M14X1.5	24,0	17,0	25,5	9,5	20,0	19,0	19,0
1242502	R1A11ML52Q-1216	12	M16X1.5	26,0	19,0	26,0	10,0	23,0	19,0	22,0
1242503	R1A11ML52Q-1518	15	M18X1.5	28,0	21,0	30,0	11,0	25,0	22,0	24,0
1242504	R1A11ML52Q-1822	18	M22X1.5	31,5	24,0	34,0	11,0	28,0	27,0	27,0
1242505	R1A11ML52Q-2227	22	M27X2	35,5	28,0	36,0	13,5	33,0	33,0	32,0
1242506	R1A11ML52Q-2833	28	M33X2.0	38,5	31,0	40,5	13,5	41,0	41,0	41,0
1242507	R1A11ML52Q-3542	35	M42X2	48,5	38,0	48,5	13,5	51,0	48,0	50,0
1242508	R1A11ML52Q-4248	42	M48X2.0	49,0	38,0	50,0	15,0	56,0	48,0	55,0

Design and dimensions shown may be changed without prior notice

// R1E11ML52Q**Run Tee adjustable elbow connector****DIN 24° Male - Metric Male with O-Ring and retaining ring****Light Series****Complete**

Item Code	Product Code	OD1	F2	Q1 (mm)	Q2 (mm)	Q3 (mm)	LT (mm)	G (mm)	CH (mm)	CH1 (mm)	LN (mm)
1243954	R1A11ML52Q-0610_A	6	M10X1.0	29,0	14,0	20,0	7,5	15,0	14,0	14,0	14,0
1243955	R1A11ML52Q-0812_A	8	M12X1.5	31,0	16,0	22,5	9,5	18,0	14,0	17,0	17,0
1243956	R1A11ML52Q-1014_A	10	M14X1.5	32,0	17,0	25,5	9,5	20,0	19,0	19,0	19,0
1243957	R1A11ML52Q-1216_A	12	M16X1.5	34,0	19,0	26,0	10,0	23,0	19,0	22,0	22,0
1243958	R1A11ML52Q-1518_A	15	M18X1.5	36,0	21,0	30,0	11,0	25,0	22,0	27,0	24,0
1243959	R1A11ML52Q-1822_A	18	M22X1.5	40,0	24,0	34,0	11,0	28,0	27,0	32,0	27,0
1243960	R1A11ML52Q-2227_A	22	M27X2	44,0	28,0	36,0	13,5	33,0	33,0	36,0	32,0
1243961	R1A11ML52Q-2833_A	28	M33X2.0	47,0	31,0	40,5	13,5	41,0	41,0	41,0	41,0
1243962	R1A11ML52Q-3542_A	35	M42X2	59,0	38,0	48,5	13,5	51,0	48,0	50,0	50,0
1243963	R1A11ML52Q-4248_A	42	M48X2.0	61,0	38,0	50,0	15,0	56,0	48,0	60,0	55,0

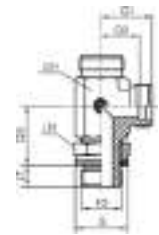
// R1A12ML52Q**Run Tee adjustable elbow connector****DIN 24° Male - Metric Male with O-Ring and retaining ring****Heavy Series**

Item Code	Product Code	OD1	F2	Q1 (mm)	Q2 (mm)	Q3 (mm)	LT (mm)	G (mm)	CH (mm)	LN (mm)
1242509	R1A12ML52Q-0612	6	M12X1.5	22,5	15,5	23,5	9,5	18,0	14,0	17,0
1242510	R1A12ML52Q-0814	8	M14X1.5	25,0	18,0	26,5	9,5	20,0	19,0	19,0
1242511	R1A12ML52Q-1016	10	M16X1.5	25,5	18,0	27,0	11,0	23,0	19,0	22,0
1242512	R1A12ML52Q-1218	12	M18X1.5	29,5	22,0	30,5	12,5	25,0	22,0	24,0
1242513	R1A12ML52Q-1622	16	M22X1.5	33,5	25,0	37,0	13,0	28,0	27,0	27,0
1242514	R1A12ML52Q-2027	20	M27X2	38,5	28,0	39,5	14,0	33,0	33,0	32,0
1242515	R1A12ML52Q-2533	25	M33X2.0	45,5	30,5	43,0	14,0	41,0	41,0	41,0
1242516	R1A12ML52Q-3042	30	M42X2	49,5	36,0	52,0	16,0	51,0	48,0	50,0
1242517	R1A12ML52Q-3848	38	M48X2.0	50,0	34,0	51,0	18,0	56,0	48,0	55,0

// R1E12ML52Q

Run Tee adjustable elbow connector

DIN 24° Male - Metric Male with O-Ring and retaining ring

Heavy Series

Complete



Item Code	Product Code	OD1	F2	Q1 (mm)	Q2 (mm)	Q3 (mm)	LT (mm)	G (mm)	CH (mm)	CH1 (mm)	LN (mm)
1244322	R1A12ML52Q-0612_A	6	M12X1.5	30,5	15,5	23,5	9,5	18,0	14,0	17,0	17,0
1244323	R1A12ML52Q-0814_A	8	M14X1.5	33,0	18,0	26,5	9,5	20,0	19,0	19,0	19,0
1244324	R1A12ML52Q-1016_A	10	M16X1.5	34,0	18,0	27,0	11,0	23,0	19,0	22,0	22,0
1244325	R1A12ML52Q-1218_A	12	M18X1.5	38,0	22,0	30,5	12,5	25,0	22,0	24,0	24,0
1244326	R1A12ML52Q-1622_A	16	M22X1.5	43,0	25,0	37,0	13,0	28,0	27,0	30,0	27,0
1244327	R1A12ML52Q-2027_A	20	M27X2	49,0	28,0	39,5	14,0	33,0	33,0	36,0	32,0
1244328	R1A12ML52Q-2533_A	25	M33X2.0	54,5	30,5	43,0	14,0	41,0	41,0	46,0	41,0
1244329	R1A12ML52Q-3042_A	30	M42X2	62,0	36,0	52,0	16,0	51,0	48,0	50,0	50,0
1244330	R1A12ML52Q-3848_A	38	M48X2.0	65,0	34,0	51,0	18,0	56,0	48,0	60,0	55,0

// R1A11M152I

Straight connector

DIN 24° Male Metric cylindric Male with elastomer

Light Series

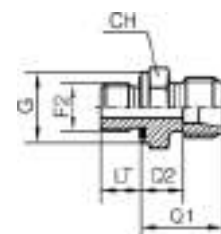

Item Code	Product Code	OD1	F2	Q1 (mm)	Q2 (mm)	LT (mm)	G (mm)	CH (mm)
1206135	R1A11M152I-0610	6	M10X1.0	15,5	8,5	8,0	14,0	14,0
1206136	R1A11M152I-0812	8	M12X1.5	17,0	10,0	12,0	17,0	17,0
1206137	R1A11M152I-1014	10	M14X1.5	18,0	11,0	12,0	19,0	19,0
1206163	R1A11M152I-1216	12	M16X1.5	19,5	12,5	12,0	22,0	22,0
1206138	R1A11M152I-1518	15	M18X1.5	20,5	14,0	14,0	24,0	24,0
1206085	R1A11M152I-1822	18	M22X1.5	22,0	14,5	14,0	27,0	27,0
1206284	R1A11M152I-2226	22	M26X1.5	24,0	16,5	16,0	32,0	32,0
1207004	R1A11M152I-2833	28	M33X2.0	25,0	17,5	18,0	40,0	41,0
1207005	R1A11M152I-3542	35	M42X2	28,0	17,5	20,0	50,0	50,0

Design and dimensions shown may be changed without prior notice

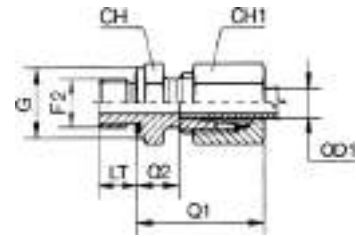
// R1E11M152I**Straight connector****DIN 24° Male Metric cylindric Male with elastomer****Light Series****Complete**

Item Code	Product Code	OD1	F2	Q1 (mm)	Q2 (mm)	LT (mm)	G (mm)	CH (mm)	CH1 (mm)
1241558	R1A11M152I-0610_A	6	M12X1.5	23,0	8,5	8,0	14,0	14,0	14,0
1241700	R1A11M152I-0812_A	8	M12X1.5	25,0	10,0	12,0	16,9	17,0	17,0
1243840	R1A11M152I-1014_A	10	M14X1.5	26,0	11,0	12,0	19,0	19,0	19,0
1243841	R1A11M152I-1216_A	12	M16X1.5	27,0	12,5	12,0	22,0	22,0	22,0
1243842	R1A11M152I-1518_A	15	M18X1.5	29,0	14,0	14,0	24,0	24,0	27,0
1243843	R1A11M152I-1822_A	18	M22X1.5	31,0	14,5	14,0	27,0	27,0	32,0
1243844	R1A11M152I-2226_A	22	M26X1.5	33,0	16,5	16,0	32,0	32,0	36,0
1243845	R1A11M152I-2833_A	28	M33X2.0	34,0	17,5	18,0	40,0	41,0	41,0
1243846	R1A11M152I-3542_A	35	M42X2	39,0	17,5	20,0	50,0	50,0	50,0

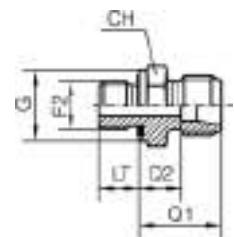
// R1A12M152I**Straight connector****DIN 24° Male - Metric cylindric Male with elastomer****Heavy Series**

Item Code	Product Code	OD1	F2	Q1 (mm)	Q2 (mm)	LT (mm)	G (mm)	CH (mm)
1206285	R1A12M152I-0612	6	M12X1.5	20,0	13,0	12,0	17,0	17,0
1207024	R1A12M152I-0814	8	M14X1.5	22,0	15,0	12,0	19,0	19,0
1206286	R1A12M152I-1016	10	M16X1.5	22,5	15,0	12,0	22,0	22,0
1206162	R1A12M152I-1218	12	M18X1.5	24,5	17,0	12,0	24,0	24,0
1211295	R1A12M152I-1420	14	M20X1.5	27,0	19,0	14,0	26,0	27,0
1206287	R1A12M152I-1622	16	M22X1.5	27,0	18,5	14,0	27,0	27,0
1241127	R1A12M152I-2027	20	M27X2	31,0	20,5	16,0	32,0	32,0
1206061	R1A12M152I-2533	25	M33X2.0	35,0	23,0	18,0	40,0	41,0
1211296	R1A12M152I-3042	30	M42X2	37,0	23,5	20,0	50,0	50,0
1208081	R1A12M152I-3848	38	M48X2.0	42,0	26,0	22,0	55,0	55,0

// R1E12M152I

Straight connector

DIN 24° Male - Metric cylindric Male with elastomer

Heavy Series

Complete

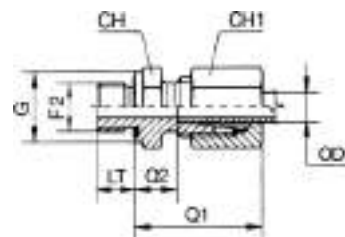

Item Code	Product Code	OD1	F2	Q1 (mm)	Q2 (mm)	LT (mm)	G (mm)	CH (mm)	CH1 (mm)
1244195	R1A12M152I-0612_A	6	M12X1.5	28,0	13,0	12,0	17,0	17,0	17,0
1244196	R1A12M152I-0814_A	8	M14X1.5	30,0	15,0	12,0	19,0	19,0	19,0
1244197	R1A12M152I-1016_A	10	M16X1.5	31,0	15,0	12,0	22,0	22,0	22,0
1244198	R1A12M152I-1218_A	12	M18X1.5	33,0	17,0	12,0	24,0	24,0	24,0
1244199	R1A12M152I-1420_A	14	M20X1.5	37,0	19,0	14,0	26,0	27,0	27,0
1244200	R1A12M152I-1622_A	16	M22X1.5	37,0	18,5	14,0	27,0	27,0	30,0
1244201	R1A12M152I-2027_A	20	M27X2	42,0	20,5	16,0	32,0	32,0	36,0
1244202	R1A12M152I-2533_A	25	M33X2.0	47,0	23,0	18,0	40,0	41,0	46,0
1244203	R1A12M152I-3042_A	30	M42X2	50,0	23,5	20,0	50,0	50,0	50,0
1244204	R1A12M152I-3848_A	38	M48X2.0	57,0	26,0	22,0	55,0	55,0	60,0

// R1A113152I

Straight connector

DIN 24° Female pre-assembled - Metric cylindric Male with elastomer

Light Series

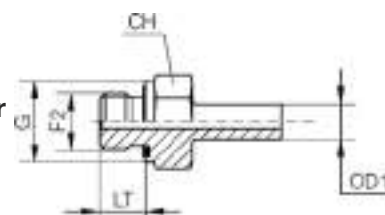

Item Code	Product Code	OD1	F1	F2	LT (mm)	G (mm)	L1 (mm)	CH (mm)
1206979	R1A113152I-0610	6	M12X1.5	M10X1.0	8,0	14,0	32,5	14,0
1206980	R1A113152I-0812	8	M14X1.5	M12X1.5	12,0	17,0	38,5	17,0
1206981	R1A113152I-1014	10	M16X1.5	M14X1.5	12,0	19,0	39,0	19,0
1206288	R1A113152I-1216	12	M18X1.5	M16X1.5	12,0	22,0	42,5	22,0
1206067	R1A113152I-1518	15	M22X1.5	M18X1.5	12,0	24,0	43,5	24,0
1206982	R1A113152I-1822	18	M26X1.5	M22X1.5	14,0	27,0	45,5	27,0
1206983	R1A113152I-2226	22	M30X2	M26X1.5	16,0	32,0	48,5	32,0
1206984	R1A113152I-2833	28	M36X2	M33X2.0	18,0	40,0	53,5	41,0
1206985	R1A113152I-3542	35	M45X2	M42X2	20,0	50,0	62,5	50,0
1206986	R1A113152I-4248	42	M52X2	M48X2.0	22,0	55,0	68,5	55,0

Design and dimensions shown may be changed without prior notice

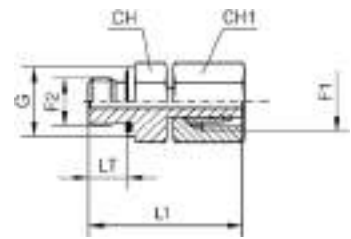
// R1E113152I**Straight connector****DIN 24° Female pre-assembled - Metric cylindric Male with elastomer
Light Series****Complete**

Item Code	Product Code	OD1	F1	F2	LT (mm)	G (mm)	L1 (mm)	CH (mm)	CH1 (mm)
1243698	R1A113152I-0610_A	6	M12X1.5	M10X1.0	8,0	14,0	32,5	14,0	14,0
1243699	R1A113152I-0812_A	8	M14X1.5	M12X1.5	12,0	17,0	38,5	17,0	17,0
1243700	R1A113152I-1014_A	10	M16X1.5	M14X1.5	12,0	19,0	39,0	19,0	19,0
1243701	R1A113152I-1216_A	12	M18X1.5	M16X1.5	12,0	22,0	42,5	22,0	22,0
1243702	R1A113152I-1518_A	15	M22X1.5	M18X1.5	12,0	24,0	43,5	24,0	27,0
1243703	R1A113152I-1822_A	18	M26X1.5	M22X1.5	14,0	27,0	45,5	27,0	32,0
1243704	R1A113152I-2226_A	22	M30X2	M26X1.5	16,0	32,0	48,5	32,0	36,0
1243705	R1A113152I-2833_A	28	M36X2	M33X2.0	18,0	40,0	53,5	41,0	41,0
1243706	R1A113152I-3542_A	35	M45X2	M42X2	20,0	50,0	62,5	50,0	50,0
1243707	R1A113152I-4248_A	42	M52X2	M48X2.0	22,0	55,0	68,5	55,0	60,0

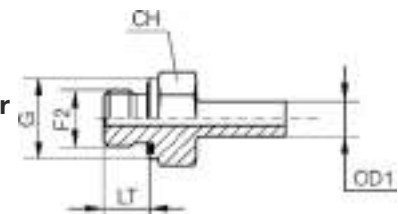
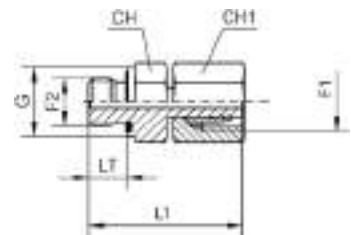
// R1A123152I**Straight connector****DIN 24° Female pre-assembled - Metric cylindric Male with elastomer
Heavy Series****// R1E123152I****Straight connector****DIN 24° Female pre-assembled - Metric cylindric Male with elastomer
Heavy Series****Complete**

Item Code	Product Code	OD1	F1	F2	LT (mm)	G (mm)	L1 (mm)	CH (mm)	CH1 (mm)
1244037	R1A123152I-0612_A	6	M14X1.5	M12X1.5	12,0	17,0	39,0	17,0	17,0
1244038	R1A123152I-0814_A	8	M16X1.5	M14X1.5	12,0	19,0	41,5	19,0	19,0
1244039	R1A123152I-1016_A	10	M18X1.5	M16X1.5	12,0	22,0	44,0	22,0	22,0
1244040	R1A123152I-1218_A	12	M20X1.5	M18X1.5	12,0	24,0	46,0	24,0	24,0
1244041	R1A123152I-1420_A	14	M22X1.5	M20X1.5	14,0	26,0	50,5	27,0	27,0
1244042	R1A123152I-1622_A	16	M24X1.5	M22X1.5	14,0	27,0	51,0	27,0	30,0
1244043	R1A123152I-2027_A	20	M30X2	M27X2	16,0	32,0	59,0	32,0	36,0
1244044	R1A123152I-2533_A	25	M36X2	M33X2.0	18,0	40,0	66,0	41,0	46,0
1244045	R1A123152I-3042_A	30	M42X2	M42X2	20,0	50,0	71,0	50,0	50,0
1244046	R1A123152I-3848_A	38	M52X2	M48X2.0	22,0	55,0	82,0	55,0	60,0

// R1A152152I

Straight connector

**DIN 24° Female with O-Ring - Metric cylindric Male with elastomer
Light series**

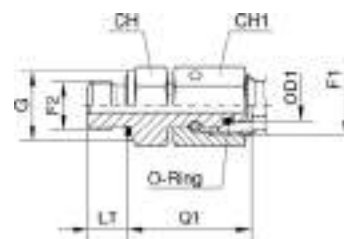

Item Code	Product Code	OD1	F1	F2	Q1 (mm)	LT (mm)	G (mm)	CH (mm)	CH1 (mm)
1211387	R1A152152I-0610	6	M12X1.5	M10X1.0	24,5	8,0	14,0	14,0	14,0
1211388	R1A152152I-0812	8	M14X1.5	M12X1.5	26,5	12,0	17,0	17,0	17,0
1211389	R1A152152I-1014	10	M16X1.5	M14X1.5	27,5	12,0	19,0	19,0	19,0
1211390	R1A152152I-1216	12	M18X1.5	M16X1.5	30,5	12,0	22,0	22,0	22,0
1211391	R1A152152I-1518	15	M22X1.5	M18X1.5	31,5	12,0	24,0	24,0	27,0
1208086	R1A152152I-1822	18	M26X1.5	M22X1.5	31,5	14,0	27,0	27,0	32,0
1211392	R1A152152I-2226	22	M30X2	M26X1.5	32,5	16,0	32,0	32,0	36,0
1211393	R1A152152I-2833	28	M36X2	M33X2.0	35,0	18,0	40,0	41,0	41,0
1211394	R1A152152I-3542	35	M45X2	M42X2	42,5	20,0	50,0	50,0	50,0
1211395	R1A152152I-4248	42	M52X2	M48X2.0	46,5	22,0	55,0	55,0	60,0

// R1A162152I

Straight connector

**DIN 24° Female with O-Ring - Metric cylindric Male with elastomer
Heavy series**

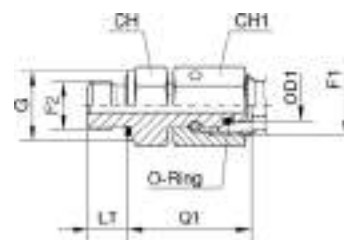

Item Code	Product Code	OD1	F1	F2	Q1 (mm)	LT (mm)	G (mm)	CH (mm)	CH1 (mm)
1211450	R1A162152I-0612	6	M14X1.5	M12X1.5	27,0	12,0	17,0	17,0	17,0
1211451	R1A162152I-0814	8	M16X1.5	M14X1.5	29,5	12,0	19,0	19,0	19,0
1211452	R1A162152I-1016	10	M18X1.5	M16X1.5	32,0	12,0	22,0	22,0	22,0
1208171	R1A162152I-1218	12	M20X1.5	M18X1.5	34,0	12,0	24,0	24,0	24,0
1208172	R1A162152I-1420	14	M22X1.5	M20X1.5	36,5	14,0	26,0	27,0	27,0
1211453	R1A162152I-1622	16	M24X1.5	M22X1.5	37,0	14,0	27,0	27,0	30,0
1211454	R1A162152I-2027	20	M30X2	M27X2	43,0	16,0	32,0	32,0	36,0
1211455	R1A162152I-2533	25	M36X2	M33X2.0	48,0	18,0	40,0	41,0	46,0
1208178	R1A162152I-3042	30	M42X2	M42X2	51,0	20,0	50,0	50,0	50,0
1208181	R1A162152I-3848	38	M52X2	M48X2.0	60,0	22,0	55,0	55,0	60,0

Design and dimensions shown may be changed without prior notice

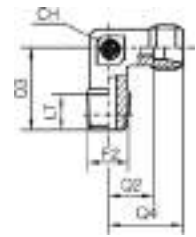
// R1A11M962M**90° elbow connector****DIN 24° Male - Metric conic Male****Light Series**

Item Code	Product Code	OD1	F2	Q1 (mm)	Q2 (mm)	Q3 (mm)	LT (mm)	CH (mm)
1206141	R1A11M962M-0610	6	M10X1.0	19,0	12,0	20,0	8,0	12,0
1206353	R1A11M962M-0812	8	M12X1.5	21,0	14,0	26,0	12,0	12,0
1205818	R1A11M962M-1014	10	M14X1.5	22,0	15,0	27,0	12,0	14,0
1205819	R1A11M962M-1216	12	M16X1.5	24,0	17,0	28,0	12,0	17,0
1206229	R1A11M962M-1518	15	M18X1.5	28,0	21,0	34,0	14,0	19,0
1208106	R1A11M962M-1822	18	M22X1.5	31,0	23,5	36,0	14,0	24,0

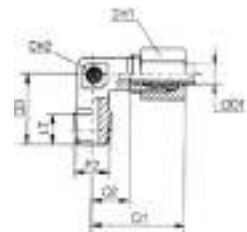
// R1E11M962M**90° elbow connector****DIN 24° Male - Metric conic Male****Light Series****Complete**

Item Code	Product Code	OD1	F2	Q1 (mm)	Q2 (mm)	Q3 (mm)	LT (mm)	CH (mm)	CH1 (mm)
1241928	R1A11M962M-0610_A	6	M10X1.0	27,0	12,0	20,0	8,0	12,0	14,0
1243892	R1A11M962M-0812_A	8	M12X1.5	29,0	14,0	26,0	12,0	12,0	17,0
1243893	R1A11M962M-1014_A	10	M14X1.5	30,0	15,0	27,0	12,0	14,0	19,0
1243894	R1A11M962M-1216_A	12	M16X1.5	32,0	17,0	28,0	12,0	17,0	22,0
1243895	R1A11M962M-1518_A	15	M18X1.5	36,0	21,0	34,0	14,0	19,0	27,0
1243896	R1A11M962M-1822_A	18	M22X1.5	40,0	23,5	36,0	14,0	24,0	32,0

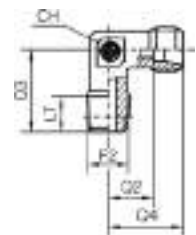
// R1A12M962M**90° elbow connector****DIN 24° Male - Metric conic Male****Heavy Series**

Item Code	Product Code	OD1	F2	Q1 (mm)	Q2 (mm)	Q3 (mm)	LT (mm)	CH (mm)
1211333	R1A12M962M-0612	6	M12X1.5	23,0	16,0	26,0	12,0	12,0
1211334	R1A12M962M-0814	8	M14X1.5	24,0	17,0	27,0	12,0	14,0
1206142	R1A12M962M-1016	10	M16X1.5	25,0	17,5	28,0	12,0	17,0
1206143	R1A12M962M-1218	12	M18X1.5	29,0	21,5	31,0	12,0	17,0
1211335	R1A12M962M-1420	14	M20X1.5	30,0	22,0	32,0	14,0	19,0
1206720	R1A12M962M-1622	16	M22X1.5	33,0	24,5	32,0	14,0	24,0

// R1E12M962M

90° elbow connector

DIN 24° Male - Metric conic Male

Heavy Series

Complete

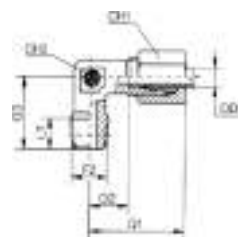

Item Code	Product Code	OD1	F2	Q1 (mm)	Q2 (mm)	Q3 (mm)	LT (mm)	CH (mm)	CH1 (mm)
1244255	R1A12M962M-0612_A	6	M12X1.5	31,0	16,0	26,0	12,0	12,0	17,0
1244256	R1A12M962M-0814_A	8	M14X1.5	32,0	17,0	27,0	12,0	14,0	19,0
1244257	R1A12M962M-1016_A	10	M16X1.5	34,0	17,5	28,0	12,0	17,0	22,0
1244258	R1A12M962M-1218_A	12	M18X1.5	38,0	21,5	31,0	12,0	17,0	24,0
1244259	R1A12M962M-1420_A	14	M20X1.5	40,0	22,0	32,0	14,0	19,0	27,0
1244260	R1A12M962M-1622_A	16	M22X1.5	43,0	24,5	32,0	14,0	24,0	30,0

// R1A11ME505

Banjo adjustable

Type A - Metric cylindric DIN 24°

Light Series

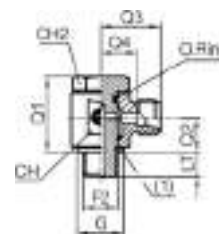

Item Code	Product Code	OD1	F2	Q1 (mm)	Q2 (mm)	Q3 (mm)	Q4 (mm)	LT (mm)	G (mm)	CH (mm)	CH2 (mm)
1205882	R1A11ME505-0610	6	M10X1.0	27,0	12,5	20,0	13,0	8,0	15,0	19,0	17,0
1206274	R1A11ME505-0812	8	M12X1.5	30,5	15,0	21,5	14,5	12,0	17,0	22,0	19,0
1244461	R1A11ME505-1014	10	M14X1.5	30,5	15,0	22,5	15,5	12,0	18,0	22,0	19,0
1206581	R1A11ME505-1216	12	M16X1.5	38,5	19,0	26,5	19,5	12,0	22,0	30,0	24,0
1206577	R1A11ME505-1518	15	M18X1.5	44,5	21,5	29,0	22,5	14,0	22,0	36,0	24,0
1206580	R1A11ME505-1822	18	M22X1.5	48,0	23,0	29,5	22,0	14,0	26,0	36,0	27,0
1206579	R1A11ME505-2226	22	M26X1.5	56,0	26,0	35,5	28,0	16,0	32,0	41,0	32,0

// R1E11ME505

Banjo adjustable

Type A - Metric cylindric DIN 24°

Light Series

Complete

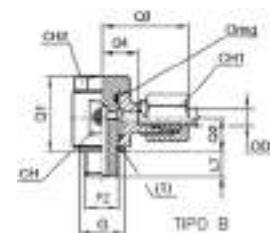

Item Code	Product Code	OD1	F2	Q1 (mm)	Q2 (mm)	Q3 (mm)	Q4 (mm)	LT (mm)	G (mm)	CH (mm)	CH1 (mm)	CH2 (mm)
1243914	R1A11ME505-0610_A	6	M10X1.0	27,0	12,5	29,0	13,0	8,0	15,0	19,0	14,0	17,0
1243915	R1A11ME505-0812_A	8	M12X1.5	30,5	15,0	30,5	14,5	12,0	17,0	22,0	17,0	19,0
1231370	R1A11ME505-1014_A	10	M14X1.5	30,5	15,0	32,0	15,5	12,0	18,0	22,0	19,0	19,0
1243916	R1A11ME505-1216_A	12	M16X1.5	38,5	19,0	36,0	19,5	12,0	22,0	30,0	22,0	24,0
1243917	R1A11ME505-1518_A	15	M18X1.5	44,5	21,5	39,0	22,5	14,0	22,0	36,0	27,0	24,0
1243918	R1A11ME505-1822_A	18	M22X1.5	48,0	23,0	40,0	22,0	14,0	26,0	36,0	32,0	27,0
1243919	R1A11ME505-2226_A	22	M26X1.5	56,0	26,0	47,0	28,0	16,0	32,0	41,0	36,0	32,0

Design and dimensions shown may be changed without prior notice

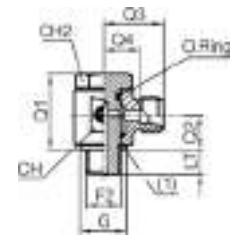
// R1A12ME505**Banjo adjustable****Type A Metric cylindric - DIN 24°****Heavy Series**

Item Code	Product Code	OD1	F2	Q1 (mm)	Q2 (mm)	Q3 (mm)	Q4 (mm)	LT (mm)	G (mm)	CH (mm)	CH2 (mm)
1207056	R1A12ME505-0612	6	M12X1.5	30,5	15,0	23,5	16,5	12,0	17,0	22,0	19,0
1207057	R1A12ME505-0814	8	M14X1.5	30,5	15,0	23,5	16,5	12,0	18,0	22,0	19,0
1208098	R1A12ME505-1016	10	M16X1.5	38,5	19,0	27,5	20,0	12,0	22,0	30,0	24,0
1206456	R1A12ME505-1218	12	M18X1.5	37,5	18,0	27,5	20,0	12,0	22,0	30,0	24,0
1208099	R1A12ME505-1420	14	M20X1.5	48,0	23,0	31,5	23,5	14,0	26,0	36,0	27,0
1206578	R1A12ME505-1622	16	M22X1.5	48,0	23,0	31,5	23,0	14,0	26,0	36,0	27,0
1211301	R1A12ME505-2027	20	M27X2	56,0	26,0	37,5	27,0	16,0	32,0	41,0	32,0

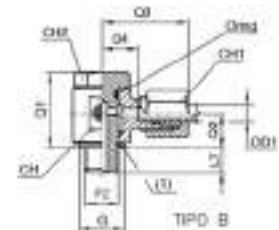
// R1E12ME505**Banjo adjustable****Type A Metric cylindric - DIN 24°****Heavy Series****Complete**

Item Code	Product Code	OD1	F2	Q1 (mm)	Q2 (mm)	Q3 (mm)	Q4 (mm)	LT (mm)	G (mm)	CH (mm)	CH1 (mm)	CH2 (mm)
1244276	R1A12ME505-0612_A	6	M12X1.5	30,5	15,0	33,0	16,5	12,0	17,0	22,0	17,0	19,0
1244277	R1A12ME505-0814_A	8	M14X1.5	30,5	15,0	32,5	16,5	12,0	18,0	22,0	19,0	19,0
1244278	R1A12ME505-1016_A	10	M16X1.5	38,5	19,0	38,0	20,0	12,0	22,0	30,0	22,0	24,0
1244279	R1A12ME505-1218_A	12	M18X1.5	37,5	18,0	38,0	20,0	12,0	22,0	30,0	24,0	24,0
1244280	R1A12ME505-1420_A	14	M20X1.5	48,0	23,0	42,5	23,5	14,0	26,0	36,0	27,0	27,0
1244281	R1A12ME505-1622_A	16	M22X1.5	48,0	23,0	43,0	23,0	14,0	26,0	36,0	30,0	27,0
1244282	R1A12ME505-2027_A	20	M27X2	56,0	26,0	51,5	27,0	16,0	32,0	41,0	36,0	32,0

// R1A11ME50M

Banjo adjustable

Type B Metric cylindric - DIN 24°

Light Series

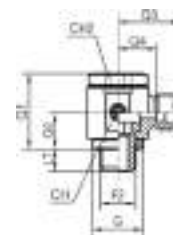

Item Code	Product Code	OD1	F2	Q1 (mm)	Q2 (mm)	Q3 (mm)	Q4 (mm)	LT (mm)	G (mm)	CH (mm)	CH2 (mm)
1211010	R1A11ME50M-0610	6	M10X1.0	24,0	12,0	19,5	12,5	8,0	14,0	19,0	6,0
1206153	R1A11ME50M-0812	8	M12X1.5	30,0	15,0	21,5	14,5	12,0	17,0	22,0	6,0
1206275	R1A11ME50M-1014	10	M14X1.5	30,0	16,0	23,0	15,5	12,0	19,0	22,0	8,0
1206276	R1A11ME50M-1216	12	M16X1.5	37,0	18,0	25,5	18,0	12,0	21,0	27,0	10,0
1206154	R1A11ME50M-1518	15	M18X1.5	40,0	20,0	28,0	21,0	12,0	23,0	30,0	12,0
1207055	R1A11ME50M-1822	18	M22X1.5	46,0	23,0	29,0	21,5	14,0	27,0	36,0	14,0
1211011	R1A11ME50M-2226	22	M26X1.5	51,0	25,0	35,0	26,0	16,0	31,0	41,0	17,0
1211012	R1A11ME50M-2833	28	M33X2.0	64,0	32,0	39,0	31,5	18,0	39,0	50,0	22,0
1211013	R1A11ME50M-3542	35	M42X2	76,0	37,0	46,0	35,5	20,0	49,0	60,0	27,0

// R1E11ME50M

Banjo adjustable

Type B Metric cylindric - DIN 24°

Light Series

Complete

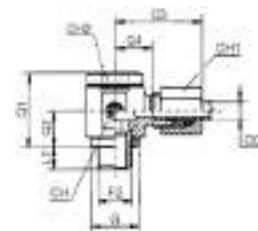

Item Code	Product Code	OD1	F2	Q1 (mm)	Q2 (mm)	Q3 (mm)	Q4 (mm)	LT (mm)	G (mm)	CH (mm)	CH1 (mm)	CH2 (mm)
1243920	R1A11ME50M-0610_A	6	M10X1.0	24,0	12,0	27,0	12,5	8,0	14,0	19,0	14,0	6,0
1243921	R1A11ME50M-0812_A	8	M12X1.5	30,0	15,0	29,0	14,5	12,0	17,0	22,0	17,0	6,0
1243922	R1A11ME50M-1014_A	10	M14X1.5	30,0	16,0	30,0	15,5	12,0	19,0	22,0	19,0	8,0
1243923	R1A11ME50M-1216_A	12	M16X1.5	37,0	18,0	33,0	18,0	12,0	21,0	27,0	22,0	10,0
1243924	R1A11ME50M-1518_A	15	M18X1.5	40,0	20,0	36,0	21,0	12,0	23,0	30,0	27,0	12,0
1243925	R1A11ME50M-1822_A	18	M22X1.5	46,0	23,0	38,0	21,5	14,0	27,0	36,0	32,0	14,0
1243926	R1A11ME50M-2226_A	22	M26X1.5	51,0	25,0	42,0	26,0	16,0	31,0	41,0	36,0	17,0
1243927	R1A11ME50M-2833_A	28	M33X2.0	64,0	32,0	48,0	31,5	18,0	39,0	50,0	41,0	22,0
1243928	R1A11ME50M-3542_A	35	M42X2	76,0	37,0	57,0	35,5	20,0	49,0	60,0	50,0	27,0

Design and dimensions shown may be changed without prior notice

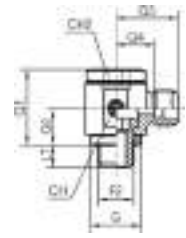
// R1A12ME50M**Banjo adjustable -****Type B Metric cylindric - DIN 24°****Heavy Series**

Item Code	Product Code	OD1	F2	Q1 (mm)	Q2 (mm)	Q3 (mm)	Q4 (mm)	LT (mm)	G (mm)	CH (mm)	CH2 (mm)
1206895	R1A12ME50M-0612	6	M12X1.5	30,0	15,0	23,5	16,5	12,0	17,0	22,0	6,0
1207058	R1A12ME50M-0814	8	M14X1.5	30,0	16,0	23,5	16,5	12,0	19,0	22,0	8,0
1206155	R1A12ME50M-1016	10	M16X1.5	37,0	18,0	26,0	18,5	12,0	21,0	27,0	10,0
1206156	R1A12ME50M-1218	12	M18X1.5	41,0	20,0	28,0	20,5	12,0	23,0	30,0	12,0
1206844	R1A12ME50M-1420	14	M20X1.5	42,0	21,0	31,0	23,0	14,0	25,0	32,0	12,0
1208221	R1A12ME50M-1622	16	M22X1.5	46,0	23,0	31,0	22,5	14,0	27,0	36,0	14,0
1207465	R1A12ME50M-2027	20	M27X2	58,0	28,0	38,0	27,5	16,0	32,0	46,0	17,0
1211200	R1A12ME50M-2533	25	M33X2.0	64,0	32,0	43,0	31,0	18,0	39,0	50,0	22,0
1208222	R1A12ME50M-3042	30	M42X2	76,0	37,0	50,0	36,5	20,0	49,0	60,0	27,0
1206157	R1A12ME50M-3848	38	M48X2.0	85,0	42,0	58,5	41,0	22,0	55,0	70,0	32,0

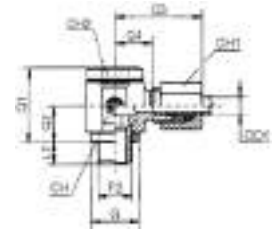
// R1E12ME50M**Banjo adjustable****Type B Metric cylindric - DIN 24°****Heavy Series****Complete**

Item Code	Product Code	OD1	F2	Q1 (mm)	Q2 (mm)	Q3 (mm)	Q4 (mm)	LT (mm)	G (mm)	CH (mm)	CH1 (mm)	CH2 (mm)
1244283	R1A12ME50M-0612_A	6	M12X1.5	30,0	15,0	31,0	16,5	12,0	17,0	22,0	17,0	6,0
1244284	R1A12ME50M-0814_A	8	M14X1.5	30,0	16,0	31,0	16,5	12,0	19,0	22,0	19,0	8,0
1244285	R1A12ME50M-1016_A	10	M16X1.5	37,0	18,0	35,0	18,5	12,0	21,0	27,0	22,0	10,0
1244286	R1A12ME50M-1218_A	12	M18X1.5	41,0	20,0	37,0	20,5	12,0	23,0	30,0	24,0	12,0
1244287	R1A12ME50M-1420_A	14	M20X1.5	42,0	21,0	41,0	23,0	14,0	25,0	32,0	27,0	12,0
1244288	R1A12ME50M-1622_A	16	M22X1.5	46,0	23,0	41,0	22,5	14,0	27,0	36,0	30,0	14,0
1244289	R1A12ME50M-2027_A	20	M27X2	58,0	28,0	49,0	27,5	16,0	32,0	46,0	36,0	17,0
1244290	R1A12ME50M-2533_A	25	M33X2.0	64,0	32,0	55,0	31,0	18,0	39,0	50,0	46,0	22,0
1244291	R1A12ME50M-3042_A	30	M42X2	76,0	37,0	63,0	36,5	20,0	49,0	60,0	50,0	27,0
1244292	R1A12ME50M-3848_A	38	M48X2.0	85,0	42,0	72,0	41,0	22,0	55,0	70,0	60,0	32,0

// BSPP

// R1A11M106M

Straight connector

DIN 24° Male - BSPP cylindric flat Male

Light Series

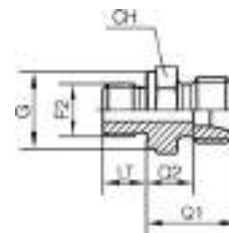

Item Code	Product Code	OD1	F2	Q1 (mm)	Q2 (mm)	LT (mm)	G (mm)	CH (mm)
1205740	R1A11M106M-0602	6	1/8-28	15,5	8,5	8,0	14,0	14,0
1204273	R1A11M106M-0604	6	1/4-19	17,0	10,0	12,0	18,0	19,0
1206930	R1A11M106M-0606	6	3/8-19	18,5	11,5	12,0	22,0	22,0
1205528	R1A11M106M-0804	8	1/4-19	17,0	10,0	12,0	18,0	19,0
1204274	R1A11M106M-0806	8	3/8-19	18,5	11,5	12,0	22,0	22,0
1206597	R1A11M106M-0808	8	1/2-14	19,0	12,0	14,0	26,0	27,0
1204262	R1A11M106M-1004	10	1/4-19	18,0	11,0	12,0	18,0	19,0
1204264	R1A11M106M-1006	10	3/8-19	19,0	12,5	12,0	22,0	22,0
1204260	R1A11M106M-1008	10	1/2-14	20,0	13,0	14,0	26,0	27,0
1205549	R1A11M106M-1204	12	1/4-19	19,0	12,0	12,0	18,0	19,0
1204268	R1A11M106M-1206	12	3/8-19	19,5	12,5	12,0	22,0	22,0
1204267	R1A11M106M-1208	12	1/2-14	20,0	13,0	14,0	26,0	27,0
1204271	R1A11M106M-1506	15	3/8-19	20,5	13,5	12,0	22,0	24,0
1204270	R1A11M106M-1508	15	1/2-14	21,0	14,0	14,0	26,0	27,0
1205741	R1A11M106M-1808	18	1/2-14	22,0	14,5	14,0	26,0	27,0
1205742	R1A11M106M-1812	18	3/4-14	22,0	14,5	16,0	32,0	32,0
1205743	R1A11M106M-2212	22	3/4-14	24,0	16,5	16,0	32,0	32,0
1205744	R1A11M106M-2816	28	1-11	25,0	17,5	18,0	39,0	41,0
1205481	R1A11M106M-3520	35	1 1/4-11	28,0	17,5	20,0	49,0	50,0
1206911	R1A11M106M-4224	42	1 1/2-11	30,0	19,0	22,0	55,0	55,0

Design and dimensions shown may be changed without prior notice

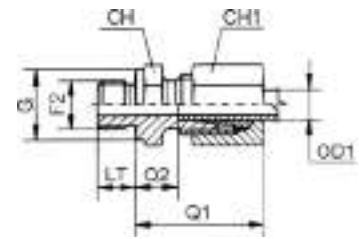
// R1E11M106M**Straight connector****DIN 24° Male - BSPP cylindric flat Male****Light Series****Complete**

Item Code	Product Code	OD1	F2	Q1 (mm)	Q2 (mm)	LT (mm)	G (mm)	CH (mm)	CH1 (mm)
1243731	R1A11M106M-0602_A	6	1/8-28	23,0	8,5	8,0	14,0	14,0	14,0
1243732	R1A11M106M-0604_A	6	1/4-19	25,0	10,0	12,0	18,0	19,0	14,0
1243733	R1A11M106M-0606_A	6	3/8-19	26,0	11,5	12,0	22,0	22,0	14,0
1242345	R1A11M106M-0804_A	8	1/4-19	25,0	10,0	12,0	18,0	19,0	17,0
1243734	R1A11M106M-0806_A	8	3/8-19	26,0	11,5	12,0	22,0	22,0	17,0
1243735	R1A11M106M-0808_A	8	1/2-14	27,0	12,0	14,0	26,0	27,0	17,0
1243736	R1A11M106M-1004_A	10	1/4-19	26,0	11,0	12,0	18,0	19,0	19,0
1243737	R1A11M106M-1006_A	10	3/8-19	27,0	12,5	12,0	22,0	22,0	19,0
1243738	R1A11M106M-1008_A	10	1/2-14	28,0	13,0	14,0	26,0	27,0	19,0
1243739	R1A11M106M-1204_A	12	1/4-19	27,0	12,0	12,0	18,0	19,0	22,0
1243740	R1A11M106M-1206_A	12	3/8-19	27,0	12,5	12,0	22,0	22,0	22,0
1241073	R1A11M106M-1208_A	12	1/2-14	28,0	13,0	14,0	26,0	27,0	22,0
1243741	R1A11M106M-1506_A	15	3/8-19	29,0	13,5	12,0	22,0	24,0	27,0
1242250	R1A11M106M-1508_A	15	1/2-14	29,0	14,0	14,0	26,0	27,0	27,0
1243742	R1A11M106M-1808_A	18	1/2-14	31,0	14,5	14,0	26,0	27,0	32,0
1243743	R1A11M106M-1812_A	18	3/4-14	30,0	14,5	16,0	32,0	32,0	32,0
1243744	R1A11M106M-2212_A	22	3/4-14	33,0	16,5	16,0	32,0	32,0	36,0
1243745	R1A11M106M-2816_A	28	1-11	34,0	17,5	18,0	39,0	41,0	41,0
1243746	R1A11M106M-3520_A	35	1 1/4-11	39,0	17,5	20,0	49,0	50,0	50,0
1243747	R1A11M106M-4224_A	42	1 1/2-11	42,0	19,0	22,0	55,0	55,0	60,0

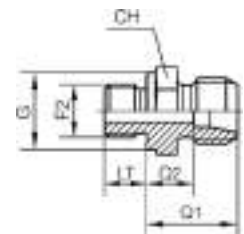
// R1A12M106M**Straight connector****DIN 24° Male - BSPP cylindric flat Male****Heavy Series**

Item Code	Product Code	OD1	F2	Q1 (mm)	Q2 (mm)	LT (mm)	G (mm)	CH (mm)
1206096	R1A12M106M-0604	6	1/4-19	20,0	13,0	12,0	18,0	19,0
1205745	R1A12M106M-0804	8	1/4-19	22,0	15,0	12,0	18,0	19,0
1205582	R1A12M106M-1006	10	3/8-19	22,5	15,0	12,0	22,0	22,0
1205746	R1A12M106M-1206	12	3/8-19	24,5	17,0	12,0	22,0	22,0
1206014	R1A12M106M-1208	12	1/2-14	25,0	17,5	14,0	26,0	27,0
1205748	R1A12M106M-1408	14	1/2-14	27,0	19,0	14,0	26,0	27,0
1205750	R1A12M106M-1608	16	1/2-14	27,0	18,5	14,0	26,0	27,0
1205884	R1A12M106M-1612	16	3/4-14	29,0	20,5	16,0	32,0	32,0
1205751	R1A12M106M-2012	20	3/4-14	31,0	20,5	16,0	32,0	32,0
1205752	R1A12M106M-2516	25	1-11	35,0	23,0	18,0	39,0	41,0
1205753	R1A12M106M-3020	30	1 1/4-11	37,0	23,5	20,0	49,0	50,0
1205754	R1A12M106M-3824	38	1 1/2-11	42,0	26,0	22,0	55,0	55,0

// R1E12M106M

Straight connector

DIN 24° Male - BSPP cylindric flat Male

Heavy Series

Complete

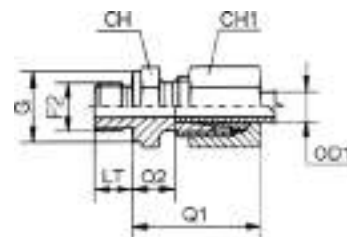

Item Code	Product Code	OD1	F2	Q1 (mm)	Q2 (mm)	LT (mm)	G (mm)	CH (mm)	CH1 (mm)
1244076	R1A12M106M-0604_A	6	1/4-19	28,0	13,0	12,0	18,0	19,0	17,0
1244077	R1A12M106M-0804_A	8	1/4-19	30,0	15,0	12,0	18,0	19,0	19,0
1244078	R1A12M106M-1006_A	10	3/8-19	31,0	15,0	12,0	22,0	22,0	22,0
1244079	R1A12M106M-1206_A	12	3/8-19	33,0	17,0	12,0	22,0	22,0	24,0
1244080	R1A12M106M-1208_A	12	1/2-14	34,0	17,5	14,0	26,0	27,0	24,0
1244081	R1A12M106M-1408_A	14	1/2-14	37,0	19,0	14,0	26,0	27,0	27,0
1244082	R1A12M106M-1608_A	16	1/2-14	37,0	18,5	14,0	26,0	27,0	30,0
1244083	R1A12M106M-1612_A	16	3/4-14	39,0	20,5	16,0	32,0	32,0	30,0
1244084	R1A12M106M-2012_A	20	3/4-14	42,0	20,5	16,0	32,0	32,0	36,0
1244085	R1A12M106M-2516_A	25	1-11	47,0	23,0	18,0	39,0	41,0	46,0
1244086	R1A12M106M-3020_A	30	1 1/4-11	50,0	23,5	20,0	49,0	50,0	50,0
1244087	R1A12M106M-3824_A	38	1 1/2-11	57,0	26,0	22,0	55,0	55,0	60,0

// R1A11M106F

Straight connector

DIN 24° Male - BSPP cylindric Female

Light Series

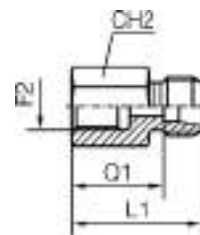

Item Code	Product Code	OD1	F2	Q1 (mm)	L1 (mm)	CH2 (mm)
1206267	R1A11M106F-0602	6	1/8-28	19,0	26,0	14,0
1205799	R1A11M106F-0804	8	1/4-19	24,0	31,0	19,0
1205800	R1A11M106F-1004	10	1/4-19	25,0	32,0	19,0
1205801	R1A11M106F-1206	12	3/8-19	26,0	33,0	24,0
1205802	R1A11M106F-1508	15	1/2-14	31,0	38,0	27,0
1205803	R1A11M106F-1808	18	1/2-14	30,5	38,0	27,0
1205547	R1A11M106F-2212	22	3/4-14	35,5	43,0	36,0
1205804	R1A11M106F-2816	28	1-11	38,0	45,5	41,0
1206998	R1A11M106F-3520	35	1 1/4-11	41,0	51,5	55,0
1208155	R1A11M106F-4224	42	1 1/2-11	42,5	53,5	60,0

Design and dimensions shown may be changed without prior notice

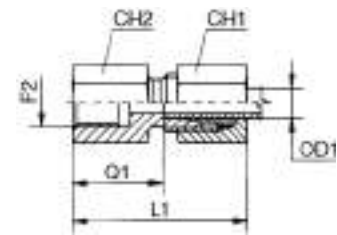
// R1E11M106F**Straight connector****DIN 24° Male - BSPP cylindric Female****Light Series****Complete**

Item Code	Product Code	OD1	F2	Q1 (mm)	L1 (mm)	CH1 (mm)	CH2 (mm)
1240579	R1A11M106F-0602_A	6	1/8-28	19,0	34,0	14,0	14,0
1241529	R1A11M106F-0804_A	8	1/4-19	24,0	39,0	17,0	19,0
1240804	R1A11M106F-1004_A	10	1/4-19	25,0	40,0	19,0	19,0
1243719	R1A11M106F-1206_A	12	3/8-19	26,0	41,0	24,0	24,0
1242104	R1A11M106F-1508_A	15	1/2-14	31,0	46,0	27,0	27,0
1243720	R1A11M106F-1808_A	18	1/2-14	30,5	47,0	27,0	27,0
1243721	R1A11M106F-2212_A	22	3/4-14	35,5	52,0	36,0	36,0
1243722	R1A11M106F-2816_A	28	1-11	38,0	55,0	41,0	41,0
1243723	R1A11M106F-3520_A	35	1 1/4-11	41,0	63,0	55,0	55,0
1243724	R1A11M106F-4224_A	42	1 1/2-11	42,5	65,0	60,0	60,0

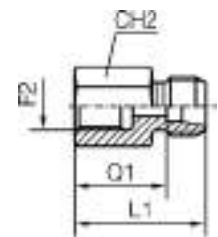
// R1A12M106F**Straight connector****DIN 24° Male - BSPP cylindric Female****Heavy Series**

Item Code	Product Code	OD1	F2	Q1 (mm)	L1 (mm)	CH2 (mm)
1206364	R1A12M106F-0604	6	1/4-19	26,0	33,0	19,0
1205805	R1A12M106F-0804	8	1/4-19	26,0	33,0	19,0
1206365	R1A12M106F-1206	12	3/8-19	26,5	34,0	24,0
1205806	R1A12M106F-1408	14	1/2-14	32,0	40,0	30,0
1205807	R1A12M106F-1608	16	1/2-14	31,5	40,0	30,0
1206268	R1A12M106F-2012	20	3/4-14	34,5	45,0	36,0
1205808	R1A12M106F-2516	25	1-11	37,5	49,5	41,0
1207021	R1A12M106F-3020	30	1 1/4-11	42,0	55,5	55,0
1207143	R1A12M106F-3824	38	1 1/2-11	43,5	59,5	60,0

// R1E12M106F

Straight connector

DIN 24° Male - BSPP cylindric Female

Heavy Series

Complete

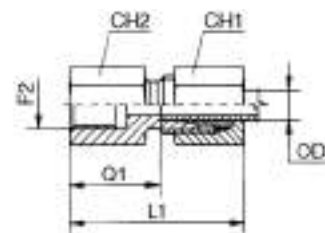

Item Code	Product Code	OD1	F2	Q1 (mm)	L1 (mm)	CH (mm)	CH1 (mm)	CH2 (mm)
1244057	R1A12M106F-0604_A	6	1/4-19	26,0	41,0	17,0	19,0	19,0
1244058	R1A12M106F-0804_A	8	1/4-19	26,0	41,0	19,0	19,0	19,0
1244059	R1A12M106F-1206_A	12	3/8-19	26,5	43,0	24,0	24,0	24,0
1244060	R1A12M106F-1408_A	14	1/2-14	32,0	50,0	27,0	30,0	30,0
1244061	R1A12M106F-1608_A	16	1/2-14	31,5	50,0	30,0	30,0	30,0
1244062	R1A12M106F-2012_A	20	3/4-14	34,5	56,0	36,0	36,0	36,0
1244063	R1A12M106F-2516_A	25	1-11	37,5	62,0	46,0	41,0	41,0
1244064	R1A12M106F-3020_A	30	1 1/4-11	42,0	69,0	50,0	55,0	55,0
1244065	R1A12M106F-3824_A	38	1 1/2-11	43,5	74,0	60,0	60,0	60,0

// R1A11M106I

Straight connector

DIN 24° Male - BSPP cylindric Male with elastomer

Light Series

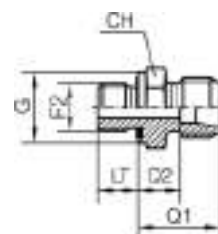

Item Code	Product Code	OD1	F2	Q1 (mm)	Q2 (mm)	LT (mm)	G (mm)	CH (mm)
1206131	R1A11M106I-0602	6	1/8-28	15,5	8,5	8,0	14,0	14,0
1205490	R1A11M106I-0804	8	1/4-19	17,0	10,0	12,0	19,0	19,0
1205760	R1A11M106I-1004	10	1/4-19	18,0	11,0	12,0	19,0	19,0
1205488	R1A11M106I-1206	12	3/8-19	19,5	12,5	12,0	22,0	22,0
1205489	R1A11M106I-1508	15	1/2-14	21,0	14,0	14,0	27,0	27,0
1206040	R1A11M106I-1808	18	1/2-14	22,0	14,5	14,0	27,0	27,0
1205761	R1A11M106I-2212	22	3/4-14	24,0	16,5	16,0	32,0	32,0
1206056	R1A11M106I-2816	28	1-11	25,0	17,5	18,0	40,0	41,0
1206283	R1A11M106I-3520	35	1 1/4-11	28,0	17,5	20,0	50,0	50,0
1206039	R1A11M106I-4224	42	1 1/2-11	30,0	19,0	22,0	55,0	55,0

Design and dimensions shown may be changed without prior notice

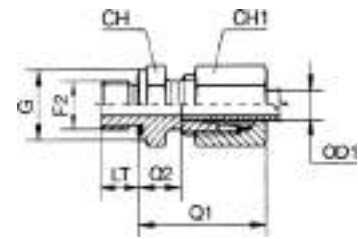
// R1E11M106I**Straight connector****DIN 24° Male - BSPP cylindric Male with elastomer****Light Series****Complete**

Item Code	Product Code	OD1	F2	Q1 (mm)	Q2 (mm)	LT (mm)	G (mm)	CH (mm)	CH1 (mm)
1242311	R1A11M106I-0602_A	6	1/8-28	23,0	8,5	8,0	14,0	14,0	14,0
1241082	R1A11M106I-0804_A	8	1/4-19	25,0	10,0	12,0	19,0	19,0	17,0
1243725	R1A11M106I-1004_A	10	1/4-19	26,0	11,0	12,0	19,0	19,0	19,0
1241083	R1A11M106I-1206_A	12	3/8-19	27,0	12,5	12,0	22,0	22,0	22,0
1241085	R1A11M106I-1508_A	15	1/2-14	29,0	14,0	14,0	27,0	27,0	27,0
1243726	R1A11M106I-1808_A	18	1/2-14	31,0	14,5	14,0	27,0	27,0	32,0
1243727	R1A11M106I-2212_A	22	3/4-14	33,0	16,5	16,0	32,0	32,0	36,0
1243728	R1A11M106I-2816_A	28	1-11	34,0	17,5	18,0	40,0	41,0	41,0
1243729	R1A11M106I-3520_A	35	1 1/4-11	39,0	17,5	20,0	50,0	50,0	50,0
1243730	R1A11M106I-4224_A	42	1 1/2-11	42,0	19,0	22,0	55,0	55,0	60,0

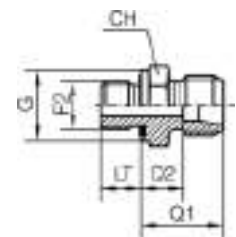
// R1A12M106I**Straight connector****DIN 24° Male - BSPP cylindric Male with elastomer****Heavy Series**

Item Code	Product Code	OD1	F2	Q1 (mm)	Q2 (mm)	LT (mm)	G (mm)	CH (mm)	CH1 (mm)
1206133	R1A12M106I-0604	6	1/4-19	20,0	13,0	12,0	19,0	19,0	19,0
1206049	R1A12M106I-0804	8	1/4-19	22,0	15,0	12,0	19,0	19,0	19,0
1206134	R1A12M106I-1006	10	3/8-19	22,5	15,0	12,0	22,0	22,0	22,0
1205901	R1A12M106I-1206	12	3/8-19	24,5	17,0	12,0	22,0	22,0	22,0
1205762	R1A12M106I-1408	14	1/2-14	27,0	19,0	14,0	27,0	27,0	27,0
1205763	R1A12M106I-1608	16	1/2-14	27,0	18,5	14,0	27,0	27,0	27,0
1205764	R1A12M106I-2012	20	3/4-14	31,0	20,5	16,0	32,0	32,0	32,0
1206047	R1A12M106I-2516	25	1-11	35,0	23,0	18,0	40,0	41,0	41,0
1206416	R1A12M106I-3020	30	1 1/4-11	37,0	23,5	20,0	50,0	50,0	50,0
1207842	R1A12M106I-3820	38	1 1/4-11	42,0	26,0	20,0	50,0	55,0	55,0

// R1E12M106I

Straight connector

DIN 24° Male - BSPP cylindric Male with elastomer

Heavy Series

Complete

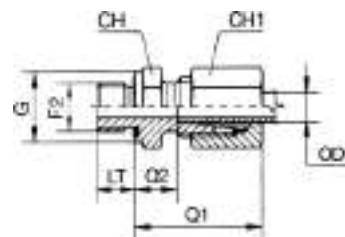

Item Code	Product Code	OD1	F2	Q1 (mm)	Q2 (mm)	LT (mm)	G (mm)	CH (mm)	CH1 (mm)
1244066	R1A12M106I-0604_A	6	1/4-19	28,0	13,0	12,0	19,0	19,0	17,0
1244067	R1A12M106I-0804_A	8	1/4-19	30,0	15,0	12,0	19,0	19,0	19,0
1244068	R1A12M106I-1006_A	10	3/8-19	31,0	15,0	12,0	22,0	22,0	22,0
1244069	R1A12M106I-1206_A	12	3/8-19	33,0	17,0	12,0	22,0	22,0	24,0
1244070	R1A12M106I-1408_A	14	1/2-14	37,0	19,0	14,0	27,0	27,0	27,0
1244071	R1A12M106I-1608_A	16	1/2-14	37,0	18,5	14,0	27,0	27,0	30,0
1244072	R1A12M106I-2012_A	20	3/4-14	42,0	20,5	16,0	32,0	32,0	36,0
1244073	R1A12M106I-2516_A	25	1-11	47,0	23,0	18,0	40,0	41,0	46,0
1244074	R1A12M106I-3020_A	30	1 1/4-11	50,0	23,5	20,0	50,0	50,0	50,0
1244075	R1A12M106I-3820_A	38	1 1/4-11	57,0	26,0	20,0	50,0	55,0	60,0

// R1A11M406N

45° adjustable elbow connector

DIN 24° Male - BSPP cylindric Male with O-Ring and retaining ring

Light Series



Item Code	Product Code	OD1	F2	Q1 (mm)	Q2 (mm)	Q3 (mm)	LT (mm)	G (mm)	CH (mm)	LN (mm)
1237030	R1A11M406N-0602	6	1/8-28	16,5	9,5	21,7	6,3	16,0	14,0	14,0
1237031	R1A11M406N-0804	8	1/4-19	19,0	12,0	19,5	9,5	20,5	14,0	19,0
1237032	R1A11M406N-1004	10	1/4-19	19,0	12,0	24,5	9,5	20,5	19,0	19,0
1237033	R1A11M406N-1206	12	3/8-19	21,0	14,0	27,5	9,5	24,0	19,0	22,0
1237034	R1A11M406N-1508	15	1/2-14	24,0	17,0	26,0	13,0	29,0	22,0	27,0
1237035	R1A11M406N-1808	18	1/2-14	24,5	17,0	32,0	13,0	29,0	27,0	27,0
1237036	R1A11M406N-2212	22	3/4-14	27,0	19,5	37,5	13,0	35,0	33,0	36,0
1231360	R1A11M406N-2816	28	1-11	30,5	23,0	36,0	16,0	44,5	41,0	41,0
1237038	R1A11M406N-3520	35	1 1/4-11	37,5	27,0	38,0	16,0	53,0	48,0	50,0
1237039	R1A11M406N-4224	42	1 1/2-11	37,0	26,0	38,0	16,0	58,5	48,0	55,0

Design and dimensions shown may be changed without prior notice

// R1E11M406N**45° adjustable elbow connector****DIN 24° Male - BSPP cylindric Male with O-Ring and retaining ring****Light Series****Complete**

Item Code	Product Code	OD1	F2	Q1 (mm)	Q2 (mm)	Q3 (mm)	LT (mm)	G (mm)	CH (mm)	CH1 (mm)	LN (mm)
1244929	R1A11M406N-0602_A	6	1/8-28	24,5	9,5	21,7	6,3	16,0	14,0	14,0	14,0
1244930	R1A11M406N-0804_A	8	1/4-19	27,0	12,0	19,5	9,5	20,5	14,0	17,0	19,0
1244931	R1A11M406N-1004_A	10	1/4-19	27,0	12,0	24,5	9,5	20,5	19,0	19,0	19,0
1244932	R1A11M406N-1206_A	12	3/8-19	29,0	14,0	27,5	9,5	24,0	19,0	22,0	22,0
1244933	R1A11M406N-1508_A	15	1/2-14	32,0	17,0	26,0	13,0	29,0	22,0	27,0	27,0
1244934	R1A11M406N-1808_A	18	1/2-14	33,0	17,0	32,0	13,0	29,0	27,0	32,0	27,0
1244935	R1A11M406N-2212_A	22	3/4-14	35,5	19,5	37,5	13,0	35,0	33,0	36,0	36,0
1244936	R1A11M406N-2816_A	28	1-11	39,0	23,0	36,0	16,0	44,5	41,0	41,0	41,0
1244937	R1A11M406N-3520_A	35	1 1/4-11	48,0	27,0	38,0	16,0	53,0	48,0	50,0	50,0
1244938	R1A11M406N-4224_A	42	1 1/2-11	49,0	26,0	38,0	16,0	58,5	48,0	60,0	55,0

// R1A12M406N**45° adjustable elbow connector****DIN 24° Male - BSPP cylindric Male with O-Ring and retaining ring****Heavy Series**

Item Code	Product Code	OD1	F2	Q1 (mm)	Q2 (mm)	Q3 (mm)	LT (mm)	G (mm)	CH (mm)	LN (mm)
1237054	R1A12M406N-0604	6	1/4-19	18,5	11,0	18,5	9,5	20,5	14,0	19,0
1237055	R1A12M406N-0804	8	1/4-19	20,5	13,0	22,5	9,5	20,5	19,0	19,0
1237056	R1A12M406N-1006	10	3/8-19	20,5	13,0	24,5	9,5	24,0	19,0	22,0
1237057	R1A12M406N-1206	12	3/8-19	24,5	17,0	24,5	9,5	24,0	22,0	22,0
1237058	R1A12M406N-1608	16	1/2-14	24,5	16,0	31,0	13,0	29,0	27,0	27,0
1237059	R1A12M406N-2012	20	3/4-14	29,5	19,0	33,0	13,0	35,0	33,0	36,0
1237060	R1A12M406N-2516	25	1-11	34,0	22,0	35,0	16,0	44,5	41,0	41,0
1237061	R1A12M406N-3020	30	1 1/4-11	37,5	24,0	37,0	16,0	53,0	48,0	50,0
1237062	R1A12M406N-3824	38	1 1/2-11	40,0	24,0	37,0	16,0	58,5	48,0	55,0

// R1E12M406N

45° adjustable elbow connector

DIN 24° Male - BSPP cylindric Male with O-Ring and retaining ring

Heavy Series

Complete



Item Code	Product Code	OD1	F2	Q1 (mm)	Q2 (mm)	Q3 (mm)	LT (mm)	G (mm)	CH (mm)	CH1 (mm)	LN (mm)
1244999	R1A12M406N-0604_A	6	1/4-19	26,0	11,0	18,5	9,5	20,5	14,0	17,0	19,0
1245000	R1A12M406N-0804_A	8	1/4-19	28,0	13,0	22,5	9,5	20,5	19,0	19,0	19,0
1245001	R1A12M406N-1006_A	10	3/8-19	29,0	13,0	24,5	9,5	24,0	19,0	22,0	22,0
1245002	R1A12M406N-1206_A	12	3/8-19	33,0	17,0	24,5	9,5	24,0	22,0	24,0	22,0
1245003	R1A12M406N-1608_A	16	1/2-14	34,0	16,0	31,0	13,0	29,0	27,0	30,0	27,0
1245004	R1A12M406N-2012_A	20	3/4-14	40,0	19,0	33,0	13,0	35,0	33,0	36,0	36,0
1245005	R1A12M406N-2516_A	25	1-11	46,0	22,0	35,0	16,0	44,5	41,0	46,0	41,0
1245006	R1A12M406N-3020_A	30	1 1/4-11	50,0	24,0	37,0	16,0	53,0	48,0	50,0	50,0
1245007	R1A12M406N-3824_A	38	1 1/2-11	55,0	24,0	37,0	16,0	58,5	48,0	60,0	55,0

// R1A11M906N

90° adjustable elbow connector

DIN 24° Male - BSPP cylindric Male with O-Ring and retaining ring

Light Series



Item Code	Product Code	OD1	F2	Q1 (mm)	Q2 (mm)	Q3 (mm)	LT (mm)	G (mm)	CH (mm)	LN (mm)
1211135	R1A11M906N-0602	6	1/8-28	21,0	14,0	20,2	6,3	16,0	14,0	14,0
1208110	R1A11M906N-0804	8	1/4-19	23,0	16,0	22,5	9,5	20,5	14,0	19,0
1208111	R1A11M906N-1004	10	1/4-19	32,0	17,0	24,5	9,5	20,5	19,0	19,0
1239726	R1A11M906N-1206	12	3/8-19	26,0	19,0	27,5	9,5	24,0	19,0	22,0
1208113	R1A11M906N-1508	15	1/2-14	28,0	21,0	30,0	13,0	29,0	22,0	27,0
1210735	R1A11M906N-1808	18	1/2-14	31,5	24,0	36,5	13,0	29,0	27,0	27,0
1206896	R1A11M906N-2212	22	3/4-14	35,5	28,0	37,5	13,0	35,0	33,0	36,0
1208114	R1A11M906N-2816	28	1-11	38,5	31,0	41,0	16,0	44,5	41,0	41,0
1211136	R1A11M906N-3520	35	1 1/4-11	48,5	38,0	49,0	16,0	53,0	48,0	50,0
1208116	R1A11M906N-4224	42	1 1/2-11	49,0	38,0	51,0	16,0	58,5	48,0	55,0

Design and dimensions shown may be changed without prior notice

// R1E11M906N**90° adjustable elbow connector****DIN 24° Male - BSPP cylindric Male with O-Ring and retaining ring****Light Series****Complete**

Item Code	Product Code	OD1	F2	Q1 (mm)	Q2 (mm)	Q3 (mm)	LT (mm)	G (mm)	CH (mm)	CH1 (mm)	LN (mm)
1243847	R1A11M906N-0602_A	6	1/8-28	29,0	14,0	20,2	6,3	16,0	14,0	14,0	14,0
1243848	R1A11M906N-0804_A	8	1/4-19	31,0	16,0	22,5	9,5	20,5	14,0	17,0	19,0
1243849	R1A11M906N-1004_A	10	1/4-19	32,0	17,0	24,5	9,5	20,5	19,0	19,0	19,0
1243850	R1A11M906N-1206_A	12	3/8-19	34,0	19,0	27,5	9,5	24,0	19,0	22,0	22,0
1243851	R1A11M906N-1508_A	15	1/2-14	36,0	21,0	30,0	13,0	29,0	22,0	27,0	27,0
1243852	R1A11M906N-1808_A	18	1/2-14	40,0	24,0	36,5	13,0	29,0	27,0	32,0	27,0
1243853	R1A11M906N-2212_A	22	3/4-14	44,0	28,0	37,5	13,0	35,0	33,0	36,0	36,0
1243854	R1A11M906N-2816_A	28	1-11	47,0	31,0	41,0	16,0	44,5	41,0	41,0	41,0
1243855	R1A11M906N-3520_A	35	1 1/4-11	59,0	38,0	49,0	16,0	53,0	48,0	50,0	50,0
1243856	R1A11M906N-4224_A	42	1 1/2-11	61,0	38,0	51,0	16,0	58,5	48,0	60,0	55,0

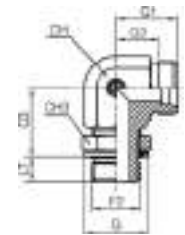
// R1A12M906N**90° adjustable elbow connector****DIN 24° Male - BSPP cylindric Male with O-Ring and retaining ring****Heavy Series**

Item Code	Product Code	OD1	F2	Q1 (mm)	Q2 (mm)	Q3 (mm)	LT (mm)	G (mm)	CH (mm)	LN (mm)
1211298	R1A12M906N-0604	6	1/4-19	22,5	15,5	22,5	9,5	20,5	14,0	19,0
1208092	R1A12M906N-0804	8	1/4-19	25,0	18,0	26,5	9,5	20,5	19,0	19,0
1208093	R1A12M906N-1006	10	3/8-19	25,5	18,0	28,5	9,5	24,0	19,0	22,0
1208094	R1A12M906N-1206	12	3/8-19	29,5	22,0	28,5	9,5	24,0	22,0	22,0
1208095	R1A12M906N-1608	16	1/2-14	33,5	25,0	36,0	13,0	29,0	27,0	27,0
1208096	R1A12M906N-2012	20	3/4-14	38,5	28,0	38,0	13,0	35,0	33,0	36,0
1208097	R1A12M906N-2516	25	1-11	42,5	30,5	41,0	16,0	44,5	41,0	41,0
1211299	R1A12M906N-3020	30	1 1/4-11	49,5	36,0	48,0	16,0	53,0	48,0	50,0
1211300	R1A12M906N-3824	38	1 1/2-11	50,0	34,0	53,0	16,0	58,5	48,0	55,0

// R1E12M906N

90° adjustable elbow connector

DIN 24° Male - BSPP cylindric Male with O-Ring and retaining ring

Heavy Series

Complete

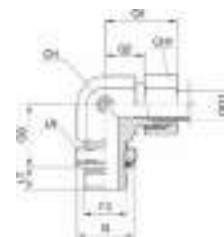

Item Code	Product Code	OD1	F2	Q1 (mm)	Q2 (mm)	Q3 (mm)	LT (mm)	G (mm)	CH (mm)	CH1 (mm)	LN (mm)
1244205	R1A12M906N-0604_A	6	1/4-19	30,5	15,5	22,5	9,5	20,5	14,0	17,0	19,0
1244206	R1A12M906N-0804_A	8	1/4-19	33,0	18,0	26,5	9,5	20,5	19,0	19,0	19,0
1244207	R1A12M906N-1006_A	10	3/8-19	34,0	18,0	28,5	9,5	24,0	19,0	22,0	22,0
1244208	R1A12M906N-1206_A	12	3/8-19	38,0	22,0	28,5	9,5	24,0	22,0	24,0	22,0
1244209	R1A12M906N-1608_A	16	1/2-14	43,0	25,0	36,0	13,0	29,0	27,0	30,0	27,0
1244210	R1A12M906N-2012_A	20	3/4-14	49,0	28,0	38,0	13,0	35,0	33,0	36,0	36,0
1244211	R1A12M906N-2516_A	25	1-11	54,5	30,5	41,0	16,0	44,5	41,0	46,0	41,0
1244212	R1A12M906N-3020_A	30	1 1/4-11	62,0	36,0	48,0	16,0	53,0	48,0	50,0	50,0
1244213	R1A12M906N-3824_A	38	1 1/2-11	65,0	34,0	53,0	16,0	58,5	48,0	60,0	55,0

// R1A11MT06N

Branch Tee adjustable elbow connector

DIN 24° Male - BSPP Male with O-Ring and retaining ring

Light Series

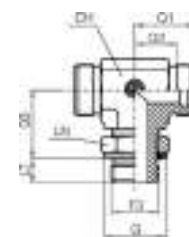

Item Code	Product Code	OD1	F3	Q1 (mm)	Q2 (mm)	Q3 (mm)	LT (mm)	G (mm)	CH (mm)	CH1 (mm)	LN (mm)
1211050	R1A11MT06N-0602	6	1/8-28	21,0	14,0	20,2	6,3	16,0	14,0	14,0	14,0
1211051	R1A11MT06N-0804	8	1/4-19	23,0	16,0	22,5	9,5	20,5	14,0	19,0	19,0
1211052	R1A11MT06N-1004	10	1/4-19	24,0	17,0	24,5	9,5	20,5	19,0	19,0	19,0
1211053	R1A11MT06N-1206	12	3/8-19	26,0	19,0	27,5	9,5	24,0	19,0	22,0	22,0
1237042	R1A11MT06N-1508	15	1/2-14	28,0	21,0	30,0	13,0	29,0	22,0	27,0	27,0
1211055	R1A11MT06N-1808	18	1/2-14	31,5	24,0	36,5	13,0	29,0	27,0	27,0	27,0
1211056	R1A11MT06N-2212	22	3/4-14	35,5	28,0	37,5	13,0	35,0	33,0	36,0	36,0
1231369	R1A11MT06N-2816	28	1-11	38,5	31,0	41,0	16,0	44,5	41,0	41,0	41,0
1208182	R1A11MT06N-3520	35	1 1/4-11	48,5	38,0	49,0	16,0	53,0	48,0	50,0	50,0
1211058	R1A11MT06N-4224	42	1 1/2-11	49,0	38,0	51,0	16,0	58,5	48,0	55,0	55,0

Design and dimensions shown may be changed without prior notice

// R1E11MT06N**Branch Tee adjustable elbow connector****DIN 24° Male - BSPP Male with O-Ring and retaining ring****Light Series****Complete**

Item Code	Product Code	OD1	F3	Q1 (mm)	Q2 (mm)	Q3 (mm)	LT (mm)	G (mm)	CH (mm)	CH1 (mm)	LN (mm)
1243964	R1A11MT06N-0602_A	6	1/8-28	29,0	14,0	20,2	6,3	16,0	14,0	14,0	14,0
1243965	R1A11MT06N-0804_A	8	1/4-19	31,0	16,0	22,5	9,5	20,5	14,0	17,0	19,0
1243966	R1A11MT06N-1004_A	10	1/4-19	32,0	17,0	24,5	9,5	20,5	19,0	19,0	19,0
1243967	R1A11MT06N-1206_A	12	3/8-19	34,0	19,0	27,5	9,5	24,0	19,0	22,0	22,0
1243968	R1A11MT06N-1508_A	15	1/2-14	36,0	21,0	30,0	13,0	29,0	22,0	27,0	27,0
1243969	R1A11MT06N-1808_A	18	1/2-14	40,0	24,0	36,5	13,0	29,0	27,0	32,0	27,0
1243970	R1A11MT06N-2212_A	22	3/4-14	44,0	28,0	37,5	13,0	35,0	33,0	36,0	36,0
1243971	R1A11MT06N-2816_A	28	1-11	47,0	31,0	41,0	16,0	44,5	41,0	41,0	41,0
1243972	R1A11MT06N-3520_A	35	1 1/4-11	59,0	38,0	49,0	16,0	53,0	48,0	50,0	50,0
1243973	R1A11MT06N-4224_A	42	1 1/2-11	61,0	38,0	51,0	16,0	58,5	48,0	60,0	55,0

// R1A12MT06N**Branch Tee adjustable elbow connector****DIN 24° Male - BSPP Male with O-Ring and retaining ring****Heavy Series**

Item Code	Product Code	OD1	F3	Q1 (mm)	Q2 (mm)	Q3 (mm)	LT (mm)	G (mm)	CH (mm)	LN (mm)
1211236	R1A12MT06N-0604	6	1/4-19	22,5	15,5	22,5	9,5	20,5	14,0	19,0
1231381	R1A12MT06N-0804	8	1/4-19	25,0	18,0	26,5	9,5	20,5	19,0	19,0
1211238	R1A12MT06N-1006	10	3/8-19	25,5	18,0	28,5	9,5	24,0	19,0	22,0
1211239	R1A12MT06N-1206	12	3/8-19	29,5	22,0	28,5	9,5	24,0	22,0	22,0
1211240	R1A12MT06N-1608	16	1/2-14	33,5	25,0	36,0	13,0	29,0	27,0	27,0
1211241	R1A12MT06N-2012	20	3/4-14	38,5	28,0	38,0	13,0	35,0	33,0	36,0
1211242	R1A12MT06N-2516	25	1-11	42,5	30,5	41,0	16,0	44,5	41,0	41,0
1211243	R1A12MT06N-3020	30	1 1/4-11	49,5	36,0	48,0	16,0	53,0	48,0	50,0
1211244	R1A12MT06N-3824	38	1 1/2-11	50,0	34,0	53,0	16,0	58,5	48,0	55,0

// R1E12MT06N

Branch Tee adjustable elbow connector
DIN 24° Male - BSPP Male with O-Ring and retaining ring
Heavy Series
Complete



Item Code	Product Code	OD1	F3	Q1 (mm)	Q2 (mm)	Q3 (mm)	LT (mm)	G (mm)	CH (mm)	CH1 (mm)	LN (mm)
1244331	R1A12MT06N-0604_A	6	1/4-19	30,5	15,5	22,5	9,5	20,5	14,0	17,0	19,0
1244332	R1A12MT06N-0804_A	8	1/4-19	33,0	18,0	26,5	9,5	20,5	19,0	19,0	19,0
1244333	R1A12MT06N-1006_A	10	3/8-19	34,0	18,0	28,5	9,5	24,0	19,0	22,0	22,0
1244334	R1A12MT06N-1206_A	12	3/8-19	38,0	22,0	28,5	9,5	24,0	22,0	24,0	22,0
1244335	R1A12MT06N-1608_A	16	1/2-14	43,0	25,0	36,0	13,0	29,0	27,0	30,0	27,0
1244336	R1A12MT06N-2012_A	20	3/4-14	49,0	28,0	38,0	13,0	35,0	33,0	36,0	36,0
1244337	R1A12MT06N-2516_A	25	1-11	54,5	30,5	41,0	16,0	44,5	41,0	46,0	41,0
1244338	R1A12MT06N-3020_A	30	1 1/4-11	62,0	36,0	48,0	16,0	53,0	48,0	50,0	50,0
1244339	R1A12MT06N-3824_A	38	1 1/2-11	65,0	34,0	53,0	16,0	58,5	48,0	60,0	55,0

// R1A11ML06N

Run Tee adjustable elbow connector
DIN 24° Male - BSPP Male with O-Ring and retaining ring
Light Series



Item Code	Product Code	OD1	F2	Q1 (mm)	Q2 (mm)	Q3 (mm)	LT (mm)	G (mm)	CH (mm)	LN (mm)
1211019	R1A11ML06N-0602	6	1/8-28	21,0	14,0	20,2	6,3	16,0	14,0	14,0
1210734	R1A11ML06N-0804	8	1/4-19	23,0	16,0	22,5	9,5	20,5	14,0	19,0
1211020	R1A11ML06N-1004	10	1/4-19	24,0	17,0	24,5	9,5	20,5	19,0	19,0
1211021	R1A11ML06N-1206	12	3/8-19	26,0	19,0	27,5	9,5	24,0	19,0	22,0
1211022	R1A11ML06N-1508	15	1/2-14	28,0	21,0	30,0	13,0	29,0	22,0	27,0
1211023	R1A11ML06N-1808	18	1/2-14	31,5	24,0	36,5	13,0	29,0	27,0	27,0
1231368	R1A11ML06N-2212	22	3/4-14	35,5	28,0	37,5	13,0	35,0	33,0	36,0
1211025	R1A11ML06N-2816	28	1-11	38,5	31,0	41,0	16,0	44,5	41,0	41,0
1211026	R1A11ML06N-3520	35	1 1/4-11	48,5	38,0	49,0	16,0	53,0	48,0	50,0
1211027	R1A11ML06N-4224	42	1 1/2-11	49,0	38,0	51,0	16,0	58,5	48,0	55,0

Design and dimensions shown may be changed without prior notice

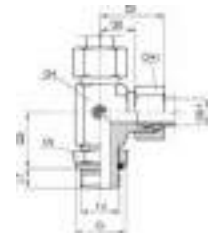
// R1E11ML06N**Run Tee adjustable elbow connector****DIN 24° Male - BSPP Male with O-Ring and retaining ring****Light Series****Complete**

Item Code	Product Code	OD1	F2	Q1 (mm)	Q2 (mm)	Q3 (mm)	LT (mm)	G (mm)	CH (mm)	CH1 (mm)	LN (mm)
1243929	R1A11ML06N-0602_A	6	1/8-28	29,0	14,0	20,2	6,3	16,0	14,0	14,0	14,0
1243930	R1A11ML06N-0804_A	8	1/4-19	31,0	16,0	22,5	9,5	20,5	14,0	17,0	19,0
1243931	R1A11ML06N-1004_A	10	1/4-19	32,0	17,0	24,5	9,5	20,5	19,0	19,0	19,0
1243932	R1A11ML06N-1206_A	12	3/8-19	34,0	19,0	27,5	9,5	24,0	19,0	22,0	22,0
1243933	R1A11ML06N-1508_A	15	1/2-14	36,0	21,0	30,0	13,0	29,0	22,0	27,0	27,0
1243934	R1A11ML06N-1808_A	18	1/2-14	40,0	24,0	36,5	13,0	29,0	27,0	32,0	27,0
1243935	R1A11ML06N-2212_A	22	3/4-14	44,0	28,0	37,5	13,0	35,0	33,0	36,0	36,0
1243936	R1A11ML06N-2816_A	28	1-11	47,0	31,0	41,0	16,0	44,5	41,0	41,0	41,0
1243937	R1A11ML06N-3520_A	35	1 1/4-11	59,0	38,0	49,0	16,0	53,0	48,0	50,0	50,0
1243938	R1A11ML06N-4224_A	42	1 1/2-11	61,0	38,0	51,0	16,0	58,5	48,0	60,0	55,0

// R1A12ML06N**Run Tee adjustable elbow connector****DIN 24° Male - BSPP Male with O-Ring and retaining ring****Heavy Series**

Item Code	Product Code	OD1	F2	Q1 (mm)	Q2 (mm)	Q3 (mm)	LT (mm)	G (mm)	CH (mm)	LN (mm)
1211207	R1A12ML06N-0604	6	1/4-19	22,5	15,5	22,5	9,5	20,5	14,0	19,0
1231380	R1A12ML06N-0804	8	1-11	25,0	18,0	26,5	9,5	20,5	19,0	19,0
1211209	R1A12ML06N-1006	10	3/8-19	25,5	18,0	28,5	9,5	24,0	19,0	22,0
1211210	R1A12ML06N-1206	12	3/8-19	29,5	22,0	28,5	9,5	24,0	22,0	22,0
1211211	R1A12ML06N-1608	16	1/2-14	33,5	25,0	36,0	13,0	29,0	27,0	27,0
1211212	R1A12ML06N-2012	20	3/4-14	38,5	28,0	38,0	13,0	35,0	33,0	36,0
1211213	R1A12ML06N-2516	25	1-11	42,5	30,5	41,0	16,0	44,5	41,0	41,0
1211214	R1A12ML06N-3020	30	1 1/4-11	49,5	36,0	48,0	16,0	53,0	48,0	50,0
1211215	R1A12ML06N-3824	38	1 1/2-11	50,0	34,0	53,0	16,0	58,5	48,0	55,0

// R1E12ML06N

Run Tee adjustable elbow connector
DIN 24° Male - BSPP Male with O-Ring and retaining ring
Heavy Series
Complete



Item Code	Product Code	OD1	F2	Q1 (mm)	Q2 (mm)	Q3 (mm)	LT (mm)	G (mm)	CH (mm)	CH1 (mm)	LN (mm)
1244293	R1A12ML06N-0604_A	6	1/4-19	30,5	15,5	22,5	9,5	20,5	14,0	17,0	19,0
1244294	R1A12ML06N-0804_A	8	1-11	33,0	18,0	26,5	9,5	20,5	19,0	19,0	19,0
1244295	R1A12ML06N-1006_A	10	3/8-19	34,0	18,0	28,5	9,5	24,0	19,0	22,0	22,0
1244296	R1A12ML06N-1206_A	12	3/8-19	38,0	22,0	28,5	9,5	24,0	22,0	24,0	22,0
1244297	R1A12ML06N-1608_A	16	1/2-14	43,0	25,0	36,0	13,0	29,0	27,0	30,0	27,0
1244298	R1A12ML06N-2012_A	20	3/4-14	49,0	28,0	38,0	13,0	35,0	33,0	36,0	36,0
1244299	R1A12ML06N-2516_A	25	1-11	54,5	30,5	41,0	16,0	44,5	41,0	46,0	41,0
1244300	R1A12ML06N-3020_A	30	1 1/4-11	62,0	36,0	48,0	16,0	53,0	48,0	50,0	50,0
1244301	R1A12ML06N-3824_A	38	1 1/2-11	65,0	34,0	53,0	16,0	58,5	48,0	60,0	55,0

// R1A152106I

Straight connector
DIN 24° Female with O-Ring - BSPP cylindric Male with elastomer
Light series

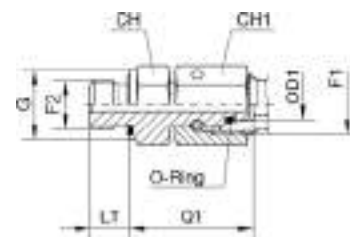

Item Code	Product Code	OD1	F1	F2	Q1 (mm)	LT (mm)	G (mm)	CH (mm)	CH1 (mm)
1208044	R1A152106I-1808	18	M26X1.5	1/2-14	31,5	14,0	27,0	27,0	32,0
1211383	R1A152106I-0602	6	M12X1.5	1/8-28	24,5	8,0	14,0	14,0	14,0
1211384	R1A152106I-2816	28	M36X2	1-11	35,0	18,0	40,0	41,0	41,0
1211385	R1A152106I-3520	35	M45X2	1 1/4-11	42,5	20,0	50,0	50,0	50,0
1208085	R1A152106I-2212	22	M30X2	3/4-14	32,5	16,0	32,0	32,0	36,0
1211386	R1A152106I-4224	42	M52X2	1 1/2-11	46,5	22,0	55,0	55,0	60,0
1206814	R1A152106I-1004	10	M16X1.5	1/4-19	27,5	12,0	19,0	19,0	19,0
1208084	R1A152106I-1508	15	M22X1.5	1/2-14	32,0	14,0	27,0	27,0	27,0
1206558	R1A152106I-1206	12	M18X1.5	3/8-19	34,0	12,0	22,0	22,0	22,0
1206931	R1A152106I-0804	8	M14X1.5	1/4-19	29,5	12,0	19,0	19,0	17,0

Design and dimensions shown may be changed without prior notice

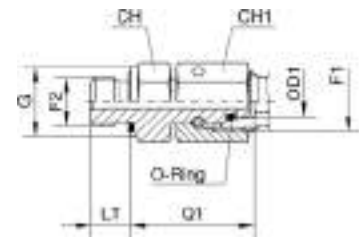
// R1A162106I**Straight connector****DIN 24° Female with O-Ring - BSPP cylindric Male with elastomer****Heavy series**

Item Code	Product Code	OD1	F1	F2	Q1 (mm)	LT (mm)	G (mm)	CH (mm)	CH1 (mm)
1211449	R1A162106I-3824	38	M52X2	1 1/2-11	60,0	22,0	55,0	55,0	60,0
1208168	R1A162106I-1006	10	M18X1.5	3/8-19	32,0	12,0	22,0	22,0	22,0
1207555	R1A162106I-2012	20	M30X2	3/4-14	43,0	16,0	32,0	32,0	36,0
1206834	R1A162106I-0804	8	M16X1.5	1/4-19	29,5	12,0	19,0	19,0	19,0
1208170	R1A162106I-1408	14	M22X1.5	1/2-14	36,5	14,0	27,0	27,0	27,0
1206561	R1A162106I-1608	16	M24X1.5	1/2-14	37,0	14,0	27,0	27,0	30,0
1208169	R1A162106I-1206	12	M20X1.5	3/8-19	34,0	12,0	22,0	22,0	24,0
1211448	R1A162106I-0604	6	M14X1.5	1/4-19	27,0	12,0	19,0	19,0	17,0
1207544	R1A162106I-3020	30	M42X2	1 1/4-11	51,0	20,0	50,0	50,0	50,0
1207131	R1A162106I-2516	25	M36X2	1-11	48,0	18,0	40,0	41,0	46,0

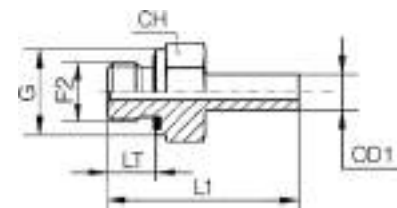
// R1A113106I**Straight connector****DIN 24° Female pre-assembled - BSPP cylindric Male with elastomer****Light Series**

Item Code	Product Code	OD1	F1	F2	LT (mm)	G (mm)	L1 (mm)	CH (mm)
1206303	R1A113106I-0602	6	M12X1.5	1/8-28	8,0	14,0	32,5	14,0
1243689	R1A113106I-0804	8	M14X1.5	1/4-19	12,0	19,0	41,5	19,0
1205573	R1A113106I-1004	10	M16X1.5	1/4-19	12,0	19,0	39,5	19,0
1205553	R1A113106I-1206	12	M18X1.5	3/8-19	12,0	22,0	46,0	22,0
1205554	R1A113106I-1508	15	M22X1.5	1/2-14	14,0	27,0	46,0	27,0
1205766	R1A113106I-1808	18	M26X1.5	1/2-14	14,0	27,0	45,5	27,0
1205555	R1A113106I-2212	22	M30X2	3/4-14	16,0	32,0	48,5	32,0
1206073	R1A113106I-2816	28	M36X2	1-11	18,0	40,0	53,0	41,0
1206000	R1A113106I-3520	35	M45X2	1 1/4-11	20,0	50,0	62,5	50,0
1206492	R1A113106I-4224	42	M52X2	1 1/2-11	22,0	55,0	68,5	55,0

// R1E113106I

Straight connector

DIN 24° Female pre-assembled - BSPP cylindric Male with elastomer

Light Series

Complete

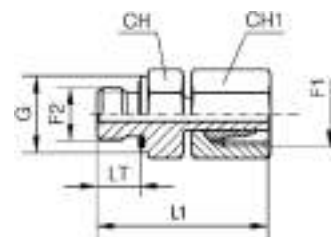

Item Code	Product Code	OD1	F1	F2	LT (mm)	G (mm)	L1 (mm)	CH (mm)	CH1 (mm)
1243688	R1A113106I-0602_A	6	M12X1.5	1/8-28	8,0	14,0	32,5	14,0	14,0
1205583	R1A113106I-0804_A	8	M14X1.5	1/4-19	12,0	19,0	41,5	19,0	17,0
1243690	R1A113106I-1004_A	10	M16X1.5	1/4-19	12,0	19,0	39,5	19,0	19,0
1243691	R1A113106I-1206_A	12	M18X1.5	3/8-19	12,0	22,0	46,0	22,0	22,0
1243692	R1A113106I-1508_A	15	M22X1.5	1/2-14	14,0	27,0	46,0	27,0	27,0
1243693	R1A113106I-1808_A	18	M26X1.5	1/2-14	14,0	27,0	45,5	27,0	32,0
1243694	R1A113106I-2212_A	22	M30X2	3/4-14	16,0	32,0	48,5	32,0	36,0
1243695	R1A113106I-2816_A	28	M36X2	1-11	18,0	40,0	53,0	41,0	41,0
1243696	R1A113106I-3520_A	35	M45X2	1 1/4-11	20,0	50,0	62,5	50,0	50,0
1243697	R1A113106I-4224_A	42	M52X2	1 1/2-11	22,0	55,0	68,5	55,0	60,0

// R1A123106I

Straight connector

DIN 24° Female pre-assembled - BSPP cylindric Male with elastomer

Heavy Series

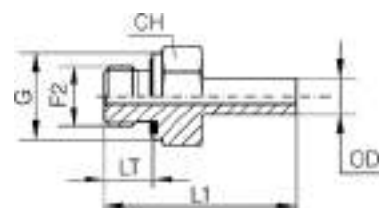

Item Code	Product Code	OD1	F1	F2	LT (mm)	G (mm)	L1 (mm)	CH (mm)
1206485	R1A123106I-0604	6	M14X1.5	1/4-19	12,0	19,0	39,0	19,0
1206035	R1A123106I-0804	8	M16X1.5	1/4-19	12,0	19,0	41,5	19,0
1206487	R1A123106I-1006	10	M18X1.5	3/8-19	12,0	22,0	44,5	22,0
1206034	R1A123106I-1206	12	M20X1.5	3/8-19	12,0	22,0	46,0	22,0
1206033	R1A123106I-1408	14	M22X1.5	1/2-14	14,0	27,0	51,0	27,0
1206032	R1A123106I-1608	16	M24X1.5	1/2-14	14,0	27,0	50,5	27,0
1206031	R1A123106I-2012	20	M30X2	3/4-14	16,0	32,0	59,0	32,0
1206030	R1A123106I-2516	25	M36X2	1-11	18,0	40,0	66,0	41,0
1206490	R1A123106I-3020	30	M42X2	1 1/4-11	20,0	50,0	71,0	50,0
1206491	R1A123106I-3824	38	M52X2	1 1/2-11	22,0	55,0	82,0	55,0

Design and dimensions shown may be changed without prior notice

// R1E123106I

Straight connector

DIN 24° Female pre-assembled - BSPP cylindric Male with elastomer

Heavy Series

Complete

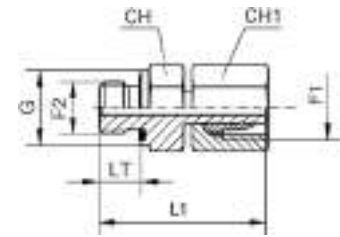

Item Code	Product Code	OD1	F1	F2	LT (mm)	G (mm)	L1 (mm)	CH (mm)	CH1 (mm)
1244027	R1A123106I-0604_A	6	M14X1.5	1/4-19	12,0	19,0	39,0	19,0	17,0
1244028	R1A123106I-0804_A	8	M16X1.5	1/4-19	12,0	19,0	41,5	19,0	19,0
1244029	R1A123106I-1006_A	10	M18X1.5	3/8-19	12,0	22,0	44,5	22,0	22,0
1244030	R1A123106I-1206_A	12	M20X1.5	3/8-19	12,0	22,0	46,0	22,0	24,0
1244031	R1A123106I-1408_A	14	M22X1.5	1/2-14	14,0	27,0	51,0	27,0	27,0
1244032	R1A123106I-1608_A	16	M24X1.5	1/2-14	14,0	27,0	50,5	27,0	30,0
1244033	R1A123106I-2012_A	20	M30X2	3/4-14	16,0	32,0	59,0	32,0	36,0
1244034	R1A123106I-2516_A	25	M36X2	1-11	18,0	40,0	66,0	41,0	46,0
1244035	R1A123106I-3020_A	30	M42X2	1 1/4-11	20,0	50,0	71,0	50,0	50,0
1244036	R1A123106I-3824_A	38	M52X2	1 1/2-11	22,0	55,0	82,0	55,0	60,0

// R1A11ME06M

Banjo elbow

Type B - BSPP Male DIN 24°

Light Series

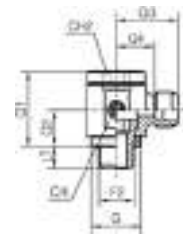

Item Code	Product Code	OD1	F2	Q1 (mm)	Q2 (mm)	Q3 (mm)	Q4 (mm)	LT (mm)	G (mm)	CH (mm)	CH2 (mm)
1207054	R1A11ME06M-0602	6	1/8-28	24,0	12,0	19,5	12,5	8,0	14,0	19,0	6,0
1206158	R1A11ME06M-0804	8	1/4-19	30,0	16,0	21,5	14,5	12,0	18,0	22,0	8,0
1243686	R1A11ME06M-1004	8	1/4-19	30,0	16,0	23,0	15,5	12,0	18,0	22,0	8,0
1206160	R1A11ME06M-1206	12	3/8-19	37,0	18,0	25,5	18,0	12,0	22,0	27,0	10,0
1206277	R1A11ME06M-1508	15	1/2-14	42,0	21,0	29,0	22,0	14,0	26,0	32,0	12,0
1211007	R1A11ME06M-1808	18	1/2-14	46,0	23,0	29,0	21,5	14,0	26,0	36,0	12,0
1211008	R1A11ME06M-2212	22	3/4-14	58,0	28,0	36,0	28,5	16,0	32,0	46,0	17,0
1208107	R1A11ME06M-2816	28	1-11	64,0	32,0	39,0	31,5	18,0	39,0	50,0	22,0
1206161	R1A11ME06M-3520	35	1 1/4-11	76,0	37,0	46,0	35,5	20,0	49,0	60,0	27,0
1211009	R1A11ME06M-4224	42	1 1/2-11	85,0	42,0	52,5	40,0	22,0	55,0	70,0	32,0

// R1E11ME06M

Banjo elbow

Type B - BSPP Male DIN 24°

Light Series

Complete

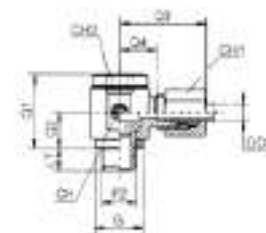

Item Code	Product Code	OD1	F2	Q1 (mm)	Q2 (mm)	Q3 (mm)	Q4 (mm)	LT (mm)	G (mm)	CH (mm)	CH1 (mm)	CH2 (mm)
1243904	R1A11ME06M-0602_A	6	1/8-28	24,0	12,0	27,0	12,5	8,0	14,0	19,0	14,0	6,0
1243905	R1A11ME06M-0804_A	8	1/4-19	30,0	16,0	29,0	14,5	12,0	18,0	22,0	17,0	8,0
1243906	R1A11ME06M-1004_A	8	1/4-19	30,0	16,0	30,0	15,5	12,0	18,0	22,0	19,0	8,0
1243907	R1A11ME06M-1206_A	12	3/8-19	37,0	18,0	33,0	18,0	12,0	22,0	27,0	22,0	10,0
1243908	R1A11ME06M-1508_A	15	1/2-14	42,0	21,0	37,0	22,0	14,0	26,0	32,0	27,0	12,0
1243909	R1A11ME06M-1808_A	18	1/2-14	46,0	23,0	38,0	21,5	14,0	26,0	36,0	32,0	12,0
1243910	R1A11ME06M-2212_A	22	3/4-14	58,0	28,0	45,0	28,5	16,0	32,0	46,0	36,0	17,0
1243911	R1A11ME06M-2816_A	28	1-11	64,0	32,0	48,0	31,5	18,0	39,0	50,0	41,0	22,0
1243912	R1A11ME06M-3520_A	35	1 1/4-11	76,0	37,0	57,0	35,5	20,0	49,0	60,0	50,0	27,0
1243913	R1A11ME06M-4224_A	42	1 1/2-11	85,0	42,0	63,0	40,0	22,0	55,0	70,0	60,0	32,0

// R1A12ME06M

Banjo elbow

Type B - BSPP Male - DIN 24°

Heavy Series

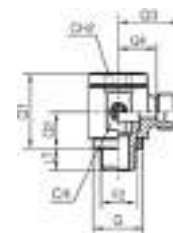

Item Code	Product Code	OD1	F2	Q1 (mm)	Q2 (mm)	Q3 (mm)	Q4 (mm)	LT (mm)	G (mm)	CH (mm)	CH2 (mm)
1206114	R1A12ME06M-0604	6	1/4-19	30,0	16,0	23,5	16,5	12,0	18,0	22,0	8,0
1206115	R1A12ME06M-0804	8	1/4-19	30,0	16,0	23,5	16,5	12,0	18,0	22,0	8,0
1206116	R1A12ME06M-1006	10	3/8-19	37,0	18,0	26,0	18,5	12,0	22,0	27,0	10,0
1206117	R1A12ME06M-1206	12	3/8-19	37,0	18,0	26,0	18,5	12,0	22,0	27,0	10,0
1207059	R1A12ME06M-1408	14	1/2-14	42,0	21,0	31,0	23,0	14,0	26,0	32,0	12,0
1211197	R1A12ME06M-2012	20	3/4-14	58,0	28,0	38,0	27,5	16,0	32,0	46,0	17,0
1211198	R1A12ME06M-2516	25	1-11	64,0	32,0	43,0	31,0	18,0	39,0	50,0	22,0
1211199	R1A12ME06M-3020	30	1 1/4-11	76,0	37,0	50,0	36,5	20,0	49,0	60,0	27,0
1208220	R1A12ME06M-3824	38	1 1/2-11	85,0	42,0	58,5	41,0	22,0	55,0	70,0	32,0

Design and dimensions shown may be changed without prior notice

// R1E12ME06M

Banjo elbow

Type B - BSPP Male - DIN 24°

Heavy Series

Complete



Item Code	Product Code	OD1	F2	Q1 (mm)	Q2 (mm)	Q3 (mm)	Q4 (mm)	LT (mm)	G (mm)	CH (mm)	CH1 (mm)	CH2 (mm)
1244268	R1A12ME06M-0604_A	6	1/4-19	30,0	16,0	31,0	16,5	12,0	18,0	22,0	17,0	8,0
1244269	R1A12ME06M-0804_A	8	1/4-19	30,0	16,0	31,0	16,5	12,0	18,0	22,0	19,0	8,0
1244270	R1A12ME06M-1006_A	10	3/8-19	37,0	18,0	35,0	18,5	12,0	22,0	27,0	22,0	10,0
1244271	R1A12ME06M-1206_A	12	3/8-19	37,0	18,0	35,0	18,5	12,0	22,0	27,0	24,0	10,0
1244267	R1A12ME06M-1408_A	14	1/2-14	42,0	21,0	41,0	23,0	14,0	26,0	32,0	27,0	12,0
1244272	R1A12ME06M-2012_A	20	3/4-14	58,0	28,0	49,0	27,5	16,0	32,0	46,0	36,0	17,0
1244273	R1A12ME06M-2516_A	25	1-11	64,0	32,0	55,0	31,0	18,0	39,0	50,0	46,0	22,0
1244274	R1A12ME06M-3020_A	30	1 1/4-11	76,0	37,0	63,0	36,5	20,0	49,0	60,0	50,0	27,0
1244275	R1A12ME06M-3824_A	38	1 1/2-11	85,0	42,0	72,0	41,0	22,0	55,0	70,0	60,0	32,0

// R1A11ME035

Banjo elbow

Type A - BSPP Male - DIN 24°

Light Series

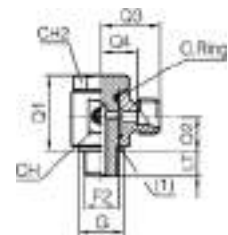

Item Code	Product Code	OD1	F2	Q1 (mm)	Q2 (mm)	Q3 (mm)	Q4 (mm)	LT (mm)	G (mm)	CH (mm)	CH2 (mm)
1206576	R1A11ME035-0602	6	1/8-28	27,0	12,5	20,0	13,0	8,0	15,0	19,0	17,0
1206148	R1A11ME035-0804	8	1/4-19	30,5	15,0	21,5	14,5	12,0	18,0	22,0	19,0
1206149	R1A11ME035-1004	10	1/4-19	30,5	15,0	22,5	15,5	12,0	18,0	22,0	19,0
1206150	R1A11ME035-1206	12	3/8-19	38,5	19,0	26,5	19,5	12,0	22,0	30,0	24,0
1206530	R1A11ME035-1508	15	1/2-14	48,0	23,0	29,5	22,5	14,0	26,0	36,0	27,0
1206531	R1A11ME035-1808	18	1/2-14	48,0	23,0	29,5	22,0	14,0	26,0	36,0	27,0
1207006	R1A11ME035-2212	22	1/8-28	56,0	26,0	35,5	28,0	16,0	32,0	41,0	32,0

// R1E11ME035

Banjo elbow

Type A - BSPP Male - DIN 24°

Light Series

Complete

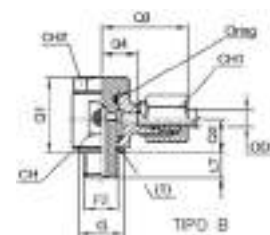

Item Code	Product Code	OD1	F2	Q1 (mm)	Q2 (mm)	Q3 (mm)	Q4 (mm)	LT (mm)	G (mm)	CH (mm)	CH1 (mm)	CH2 (mm)
1243897	R1A11ME035-0602_A	6	1/8-28	27,0	12,5	29,0	13,0	8,0	15,0	19,0	14,0	17,0
1243898	R1A11ME035-0804_A	8	1/4-19	30,5	15,0	30,5	14,5	12,0	18,0	22,0	17,0	19,0
1243899	R1A11ME035-1004_A	10	1/4-19	30,5	15,0	32,0	15,5	12,0	18,0	22,0	19,0	19,0
1243900	R1A11ME035-1206_A	12	3/8-19	38,5	19,0	36,0	19,5	12,0	22,0	30,0	22,0	24,0
1243901	R1A11ME035-1508_A	15	1/2-14	48,0	23,0	39,0	22,5	14,0	26,0	36,0	27,0	27,0
1243902	R1A11ME035-1808_A	18	1/2-14	48,0	23,0	40,0	22,0	14,0	26,0	36,0	32,0	27,0
1243903	R1A11ME035-2212_A	22	1/8-28	56,0	26,0	47,0	28,0	16,0	32,0	41,0	36,0	32,0

// R1A12ME035

Banjo elbow - Type A

BSPP Male with O-Ring - DIN 24°

Heavy series

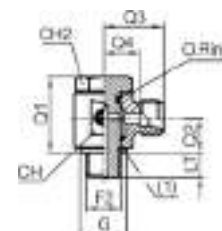

Item Code	Product Code	OD1	F2	Q1 (mm)	Q2 (mm)	Q3 (mm)	Q4 (mm)	LT (mm)	G (mm)	CH (mm)	CH2 (mm)
1206098	R1A12ME035-0604	6	1/4-19	30,5	15,0	23,5	16,5	12,0	18,0	22,0	19,0
1207025	R1A12ME035-0804	8	1/4-19	30,5	15,0	23,5	16,5	12,0	18,0	22,0	19,0
1206532	R1A12ME035-1006	10	3/8-19	38,5	19,0	27,5	20,0	12,0	22,0	24,0	22,0
1206151	R1A12ME035-1206	12	3/8-19	38,5	19,0	27,5	20,0	12,0	22,0	30,0	24,0
1206582	R1A12ME035-1408	14	1/2-14	48,0	23,0	31,5	23,5	14,0	26,0	36,0	27,0
1206533	R1A12ME035-1608	16	1/2-14	48,0	23,0	31,5	23,0	14,0	26,0	36,0	27,0
1206583	R1A12ME035-2012	20	3/4-14	56,0	26,0	37,5	27,0	16,0	32,0	41,0	32,0

// R1E12ME035

Banjo elbow

Type A - BSPP Male - DIN 24°

Heavy Series

Complete

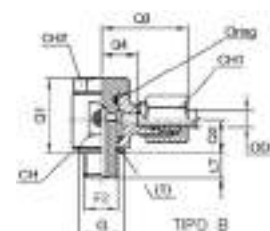

Item Code	Product Code	OD1	F2	Q1 (mm)	Q2 (mm)	Q3 (mm)	Q4 (mm)	LT (mm)	G (mm)	CH (mm)	CH1 (mm)	CH2 (mm)
1244261	R1A12ME035-0604_A	6	1/4-19	30,5	15,0	33,0	16,5	12,0	18,0	22,0	17,0	19,0
1244262	R1A12ME035-0804_A	8	1/4-19	30,5	15,0	32,5	16,5	12,0	18,0	22,0	19,0	19,0
1241550	R1A12ME035-1006_A	10	3/8-19	38,5	19,0	38,0	20,0	12,0	22,0	24,0	22,0	22,0
1244263	R1A12ME035-1206_A	12	3/8-19	38,5	19,0	38,0	20,0	12,0	22,0	30,0	24,0	24,0
1244264	R1A12ME035-1408_A	14	1/2-14	48,0	23,0	42,5	23,5	14,0	26,0	36,0	27,0	27,0
1244265	R1A12ME035-1608_A	16	1/2-14	48,0	23,0	43,0	23,0	14,0	26,0	36,0	30,0	27,0
1244266	R1A12ME035-2012_A	20	3/4-14	56,0	26,0	51,5	27,0	16,0	32,0	41,0	36,0	32,0

Design and dimensions shown may be changed without prior notice

// R1A06F106I

Straight connector

BSPP Female - BSPP Male with elastomer

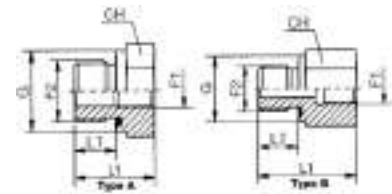

Item Code	Product Code	F1	F2	LT (mm)	G (mm)	L1 (mm)	CH (mm)	Note
1206431	R1A06F106I-0204	1/8-28	1/4-19	8,0	14,0	31,0	19,0	B
1206511	R1A06F106I-0206	1/8-28	3/8-19	8,0	14,0	32,0	24,0	B
1206510	R1A06F106I-0402	1/4-19	1/8-28	12,0	19,0	29,0	19,0	B
1206432	R1A06F106I-0406	1/4-19	3/8-19	12,0	19,0	36,0	24,0	B
1206016	R1A06F106I-0408	1/4-19	1/2-14	12,0	19,0	40,0	30,0	B
1206512	R1A06F106I-0412	1/4-19	3/4-14	12,0	19,0	43,0	36,0	B
1206509	R1A06F106I-0602	3/8-19	1/8-28	12,0	22,0	22,5	22,0	A
1206508	R1A06F106I-0604	3/8-19	1/4-19	12,0	22,0	36,0	22,0	B
1206513	R1A06F106I-0608	3/8-19	1/2-14	12,0	22,0	41,0	30,0	B
1206514	R1A06F106I-0612	3/8-19	3/4-14	12,0	22,0	44,0	36,0	B
1207863	R1A06F106I-0802	1/2-14	1/8-28	14,0	27,0	24,0	27,0	A
1206507	R1A06F106I-0804	1/2-14	1/4-19	14,0	27,0	24,0	27,0	A
1206506	R1A06F106I-0806	1/2-14	3/8-19	14,0	27,0	37,0	27,0	B
1206515	R1A06F106I-0812	1/2-14	3/4-14	14,0	27,0	46,0	36,0	B
1206420	R1A06F106I-0816	1/2-14	1-11	14,0	27,0	49,0	41,0	B
1206516	R1A06F106I-0820	1/2-14	1 1/4-11	14,0	27,0	53,0	55,0	B
1206505	R1A06F106I-1204	3/4-14	1/4-19	16,0	32,0	26,0	32,0	A
1206504	R1A06F106I-1206	3/4-14	3/8-19	16,0	32,0	26,0	32,0	A
1206419	R1A06F106I-1208	3/4-14	1/2-14	16,0	32,0	43,0	32,0	B
1206418	R1A06F106I-1216	3/4-14	1-11	16,0	32,0	51,0	41,0	B
1206422	R1A06F106I-1220	3/4-14	1 1/4-11	16,0	32,0	55,0	55,0	B
1206421	R1A06F106I-1224	3/4-14	1 1/2-11	16,0	32,0	57,0	60,0	B
1206503	R1A06F106I-1604	1-11	1/4-19	18,0	40,0	29,0	41,0	A
1206502	R1A06F106I-1606	1-11	3/8-19	18,0	40,0	29,0	41,0	A
1206501	R1A06F106I-1608	1-11	1/2-14	18,0	40,0	29,0	41,0	A
1206500	R1A06F106I-1612	1-11	3/4-14	18,0	40,0	49,0	41,0	B
1206517	R1A06F106I-1620	1-11	1 1/4-11	18,0	40,0	57,0	55,0	B
1206518	R1A06F106I-1624	1-11	1 1/2-11	18,0	40,0	59,0	60,0	B
1206499	R1A06F106I-2008	1 1/4-11	1/2-14	20,0	50,0	32,0	50,0	A
1206497	R1A06F106I-2012	1 1/4-11	3/4-14	20,0	50,0	32,0	50,0	A
1206465	R1A06F106I-2016	1 1/4-11	1-11	20,0	50,0	53,0	50,0	B
1206519	R1A06F106I-2024	1 1/4-11	1 1/2-11	20,0	50,0	60,0	60,0	B
1206496	R1A06F106I-2408	1 1/2-11	1/2-14	22,0	55,0	36,0	55,0	A
1206495	R1A06F106I-2412	1 1/2-11	3/4-14	22,0	55,0	36,0	55,0	A
1206494	R1A06F106I-2416	1 1/2-11	1-11	22,0	55,0	36,0	55,0	A
1206493	R1A06F106I-2420	1 1/2-11	1 1/4-11	22,0	55,0	58,0	55,0	B

// BSPT

// R1A11M107M

Straight connector

DIN 24° Male - BSPT cylindric flat Male

Light Series

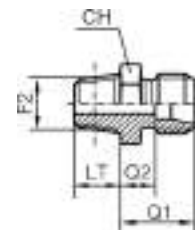

Item Code	Product Code	OD1	F2	Q1 (mm)	Q2 (mm)	LT (mm)	CH (mm)
1205767	R1A11M107M-0602	6	1/8-28	14,0	7,0	10,0	12,0
1206219	R1A11M107M-0604	6	1/4-19	15,0	8,0	13,0	17,0
1206606	R1A11M107M-0802	8	1/8-28	15,0	8,0	10,0	14,0
1205584	R1A11M107M-0804	8	1/4-19	15,0	8,0	13,0	17,0
1205587	R1A11M107M-0806	8	3/8-19	16,0	9,0	13,0	19,0
1206221	R1A11M107M-0808	8	1/2-14	16,0	9,0	16,0	22,0
1206454	R1A11M107M-1002	10	1/8-28	16,0	9,0	10,0	17,0
1204289	R1A11M107M-1004	10	1/4-19	16,0	9,0	13,0	17,0
1204290	R1A11M107M-1006	10	3/8-19	17,0	10,0	13,0	19,0
1204288	R1A11M107M-1008	10	1/2-14	17,0	10,0	16,0	22,0
1205482	R1A11M107M-1204	12	1/4-19	17,0	10,0	13,0	19,0
1204293	R1A11M107M-1206	12	3/8-19	17,0	10,0	13,0	19,0
1204292	R1A11M107M-1208	12	1/2-14	17,0	10,0	16,0	22,0
1205768	R1A11M107M-1506	15	3/8-19	18,0	11,0	13,0	24,0
1204296	R1A11M107M-1508	15	1/2-14	18,0	11,0	16,0	24,0
1244867	R1A11M107M-1806	18	3/8-19	19,0	11,5	13,0	27,0
1205769	R1A11M107M-1808	18	1/2-14	19,0	11,5	16,0	27,0
1208156	R1A11M107M-1812	18	3/4-14	19,0	11,5	18,0	32,0
1205770	R1A11M107M-2212	22	3/4-14	21,0	13,5	18,0	32,0
1205771	R1A11M107M-2816	28	1-11	22,0	14,5	20,0	41,0
1244868	R1A11M107M-3516	35	1-11	25,0	14,5	20,0	46,0
1206046	R1A11M107M-3520	35	1 1/4-11	25,0	14,5	21,0	46,0

Design and dimensions shown may be changed without prior notice

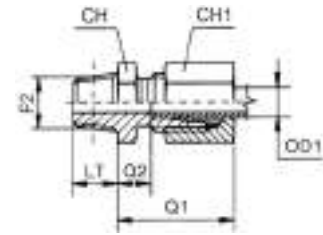
// R1E11M107M**Straight connector****DIN 24° Male - BSPT cylindric flat Male****Light Series****Complete**

Item Code	Product Code	OD1	F2	Q1 (mm)	Q2 (mm)	LT (mm)	CH (mm)	CH1 (mm)
1241561	R1A11M107M-0602_A	6	1/8-28	23,0	7,0	10,0	12,0	14,0
1242147	R1A11M107M-0604_A	6	1/4-19	24,0	8,0	13,0	17,0	14,0
1241564	R1A11M107M-0802_A	8	1/8-28	25,0	8,0	10,0	14,0	17,0
1244913	R1A11M107M-0804_A	8	1/4-19	25,0	8,0	13,0	17,0	17,0
1241960	R1A11M107M-0806_A	8	3/8-19	26,0	9,0	13,0	19,0	17,0
1244914	R1A11M107M-0808_A	8	1/2-14	26,0	9,0	16,0	22,0	17,0
1244915	R1A11M107M-1002_A	10	1/8-28	26,0	9,0	10,0	17,0	19,0
1241526	R1A11M107M-1004_A	10	1/4-19	26,0	9,0	13,0	17,0	19,0
1244916	R1A11M107M-1006_A	10	3/8-19	27,0	10,0	13,0	19,0	19,0
1244917	R1A11M107M-1008_A	10	1/2-14	27,0	10,0	16,0	22,0	19,0
1241566	R1A11M107M-1204_A	12	1/4-19	27,0	10,0	13,0	19,0	22,0
1244918	R1A11M107M-1206_A	12	3/8-19	27,0	10,0	13,0	19,0	22,0
1244919	R1A11M107M-1208_A	12	1/2-14	27,0	10,0	16,0	22,0	22,0
1244920	R1A11M107M-1506_A	15	3/8-19	29,0	11,0	13,0	24,0	27,0
1244921	R1A11M107M-1508_A	15	1/2-14	29,0	11,0	16,0	24,0	27,0
1244922	R1A11M107M-1806_A	18	3/8-19	31,0	11,5	13,0	27,0	32,0
1244923	R1A11M107M-1808_A	18	1/2-14	31,0	11,5	16,0	27,0	32,0
1244924	R1A11M107M-1812_A	18	3/4-14	32,0	11,5	18,0	32,0	32,0
1244925	R1A11M107M-2212_A	22	3/4-14	33,0	13,5	18,0	32,0	36,0
1244926	R1A11M107M-2816_A	28	1-11	34,0	14,5	20,0	41,0	41,0
1244927	R1A11M107M-3516_A	35	1-11	39,0	14,5	20,0	46,0	50,0
1244928	R1A11M107M-3520_A	35	1 1/4-11	39,0	14,5	21,0	46,0	50,0

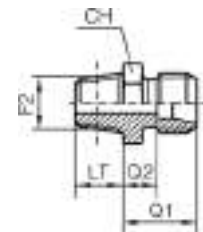
// R1A12M107M**Straight connector****DIN 24° Male - BSPT cylindric flat Male****Heavy Series**

Item Code	Product Code	OD1	F2	Q1 (mm)	Q2 (mm)	LT (mm)	CH (mm)
1205772	R1A12M107M-0604	6	1/4-19	19,0	12,0	13,0	17,0
1205773	R1A12M107M-0804	8	1/4-19	20,0	13,0	13,0	17,0
1245379	R1A12M107M-1004	10	1/4-19	20,0	12,5	13,0	19,0
1244891	R1A12M107M-1006	10	3/8-19	20,0	12,5	13,0	19,0
1245380	R1A12M107M-1204	12	1/4-19	22,0	14,5	13,0	22,0
1244892	R1A12M107M-1206	12	3/8-19	22,0	14,5	13,0	22,0
1245381	R1A12M107M-1208	12	1/2-14	22,0	14,5	16,0	22,0
1205776	R1A12M107M-1406	14	3/8-19	24,0	16,0	13,0	24,0
1205894	R1A12M107M-1408	14	1/2-14	24,0	16,0	16,0	24,0
1206082	R1A12M107M-1606	16	3/8-19	26,0	17,5	13,0	27,0
1205777	R1A12M107M-1608	16	1/2-14	26,0	17,5	16,0	27,0
1205778	R1A12M107M-2012	20	3/4-14	28,0	17,5	18,0	32,0
1244893	R1A12M107M-2516	25	1-11	30,0	18,0	20,0	41,0
1245382	R1A12M107M-3016	30	1-11	33,0	19,5	20,0	46,0
1206916	R1A12M107M-3020	30	1 1/4-11	33,0	19,5	21,0	46,0
1245383	R1A12M107M-3820	38	1 1/4-11	38,0	22,0	21,0	55,0
1207841	R1A12M107M-3824	38	1 1/2-11	38,0	22,0	22,0	55,0

// R1E12M107M

Straight connector

DIN 24° Male - BSPT cylindric flat Male

Heavy Series

Complete

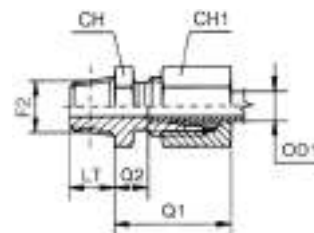

Item Code	Product Code	OD1	F2	Q1 (mm)	Q2 (mm)	LT (mm)	CH (mm)	CH1 (mm)
1244989	R1A12M107M-0604_A	6	1/4-19	28,0	12,0	13,0	17,0	17,0
1244990	R1A12M107M-0804_A	8	1/4-19	30,0	13,0	13,0	17,0	19,0
1245384	R1A12M107M-1004_A	10	1/4-19	31,0	12,5	13,0	19,0	22,0
1244991	R1A12M107M-1006_A	10	3/8-19	31,0	12,5	13,0	19,0	22,0
1245385	R1A12M107M-1204_A	12	1/4-19	33,0	14,5	13,0	22,0	24,0
1244992	R1A12M107M-1206_A	12	3/8-19	33,0	14,5	13,0	22,0	24,0
1245386	R1A12M107M-1208_A	12	1/2-14	33,0	14,5	16,0	22,0	24,0
1245388	R1A12M107M-1406_A	14	3/8-19	37,0	16,0	13,0	24,0	27,0
1244993	R1A12M107M-1408_A	14	1/2-14	37,0	16,0	16,0	24,0	27,0
1245389	R1A12M107M-1606_A	16	3/8-19	37,0	17,5	13,0	27,0	30,0
1244994	R1A12M107M-1608_A	16	1/2-14	37,0	17,5	16,0	27,0	30,0
1244995	R1A12M107M-2012_A	20	3/4-14	42,0	17,5	18,0	32,0	36,0
1244996	R1A12M107M-2516_A	25	1-11	47,0	18,0	20,0	41,0	46,0
1245390	R1A12M107M-3016_A	30	1-11	50,0	19,5	20,0	46,0	50,0
1244997	R1A12M107M-3020_A	30	1 1/4-11	50,0	19,5	21,0	46,0	50,0
1245391	R1A12M107M-3820_A	38	1 1/4-11	57,0	22,0	21,0	55,0	60,0
1244998	R1A12M107M-3824_A	38	1 1/2-11	57,0	22,0	22,0	55,0	60,0

// R1A11M907M

90° connector

DIN 24° Male - BSPT Male

Light Series

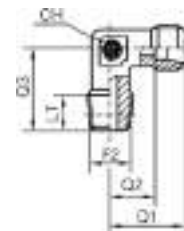

Item Code	Product Code	OD1	F2	Q1 (mm)	Q2 (mm)	Q3 (mm)	LT (mm)	CH (mm)
1205780	R1A11M907M-0602	6	1/8-28	19,0	12,0	20,0	8,0	12,0
1204096	R1A11M907M-0604	6	1/4-19	21,0	14,0	26,0	12,0	12,0
1206232	R1A11M907M-0802	8	1/8-28	21,0	14,0	26,0	8,0	12,0
1205781	R1A11M907M-0804	8	1/4-19	21,0	14,0	26,0	12,0	12,0
1204098	R1A11M907M-0806	8	3/8-19	24,0	17,0	28,0	12,0	17,0
1205782	R1A11M907M-1004	10	1/4-19	22,0	15,0	27,0	12,0	14,0
1204085	R1A11M907M-1006	10	3/8-19	24,0	17,0	28,0	12,0	17,0
1206181	R1A11M907M-1008	10	1/2-14	28,0	21,0	34,0	14,0	19,0
1205521	R1A11M907M-1204	12	1/4-19	24,0	17,0	28,0	12,0	17,0
1204089	R1A11M907M-1206	12	3/8-19	24,0	17,0	28,0	12,0	17,0
1204088	R1A11M907M-1208	12	1/2-14	28,0	21,0	34,0	14,0	19,0
1205783	R1A11M907M-1506	15	3/8-19	28,0	21,0	34,0	12,0	19,0
1204092	R1A11M907M-1508	15	1/2-14	28,0	21,0	34,0	14,0	19,0
1205784	R1A11M907M-1808	18	1/2-14	31,0	23,5	36,0	14,0	24,0
1205785	R1A11M907M-2212	22	3/4-14	25,0	27,5	42,0	16,0	27,0
1206569	R1A11M907M-2816	28	1-11	38,0	30,5	48,0	18,0	36,0
1244886	R1A11M907M-3520	35	1 1/4-11	45,0	34,5	54,0	20,0	41,0
1244887	R1A11M907M-4224	42	1 1/2-11	51,0	40,0	61,0	22,0	50,0

Design and dimensions shown may be changed without prior notice

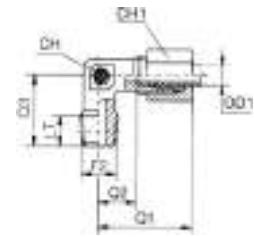
// R1E11M907M**90° connector****DIN 24° Male - BSPT Male****Light Series****Complete**

Item Code	Product Code	OD1	F2	Q1 (mm)	Q2 (mm)	Q3 (mm)	LT (mm)	CH (mm)	CH1 (mm)
1244959	R1A11M907M-0602_A	6	1/8-28	27,0	12,0	20,0	8,0	12,0	14,0
1241962	R1A11M907M-0604_A	6	1/4-19	29,0	14,0	26,0	12,0	12,0	14,0
1244960	R1A11M907M-0802_A	8	1/8-28	29,0	14,0	26,0	8,0	12,0	17,0
1243352	R1A11M907M-0804_A	8	1/4-19	29,0	14,0	26,0	12,0	12,0	17,0
1241091	R1A11M907M-0806_A	8	3/8-19	32,0	17,0	28,0	12,0	17,0	17,0
1242418	R1A11M907M-1004_A	10	1/4-19	30,0	15,0	27,0	12,0	14,0	19,0
1244961	R1A11M907M-1006_A	10	3/8-19	32,0	17,0	28,0	12,0	17,0	19,0
1244962	R1A11M907M-1008_A	10	1/2-14	36,0	21,0	34,0	14,0	19,0	19,0
1241567	R1A11M907M-1204_A	12	1/4-19	32,0	17,0	28,0	12,0	17,0	22,0
1241475	R1A11M907M-1206_A	12	3/8-19	32,0	17,0	28,0	12,0	17,0	22,0
1244963	R1A11M907M-1208_A	12	1/2-14	36,0	21,0	34,0	14,0	19,0	22,0
1244964	R1A11M907M-1506_A	15	3/8-19	36,0	21,0	34,0	12,0	19,0	27,0
1244965	R1A11M907M-1508_A	15	1/2-14	36,0	21,0	34,0	14,0	19,0	27,0
1241843	R1A11M907M-1808_A	18	1/2-14	40,0	23,5	36,0	14,0	24,0	32,0
1244966	R1A11M907M-2212_A	22	3/4-14	44,0	27,5	42,0	16,0	27,0	36,0
1244967	R1A11M907M-2816_A	28	1-11	47,0	30,5	48,0	18,0	36,0	41,0
1244968	R1A11M907M-3520_A	35	1 1/4-11	56,0	34,5	54,0	20,0	41,0	50,0
1244969	R1A11M907M-4224_A	42	1 1/2-11	63,0	40,0	61,0	22,0	50,0	60,0

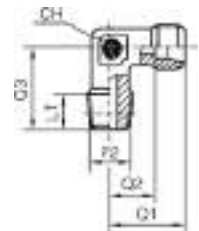
// R1A12M907M**90° connector****DIN 24° Male - BSPT Male****Heavy Series**

Item Code	Product Code	OD1	F2	Q1 (mm)	Q2 (mm)	Q3 (mm)	LT (mm)	CH (mm)
1205786	R1A12M907M-0604	6	1/4-19	23,0	16,0	26,0	12,0	12,0
1205787	R1A12M907M-0804	8	1/4-19	24,0	17,0	27,0	12,0	14,0
1205788	R1A12M907M-1006	10	3/8-19	25,0	17,5	28,0	12,0	17,0
1205789	R1A12M907M-1206	12	3/8-19	29,0	21,5	31,0	12,0	17,0
1206792	R1A12M907M-1208	12	1/2-14	30,0	22,5	32,0	14,0	19,0
1205791	R1A12M907M-1408	14	1/2-14	30,0	22,0	32,0	14,0	19,0
1206722	R1A12M907M-1606	16	3/8-19	33,0	24,5	32,0	12,0	24,0
1205792	R1A12M907M-1608	16	1/2-14	33,0	24,5	32,0	14,0	24,0
1205793	R1A12M907M-2012	20	3/4-14	37,0	26,5	42,0	16,0	27,0
1207845	R1A12M907M-2516	25	1-11	42,0	30,0	48,0	18,0	36,0
1207846	R1A12M907M-3020	30	1 1/4-11	49,0	35,5	54,0	20,0	41,0
1241128	R1A12M907M-3824	38	1 1/2-11	57,0	41,0	61,0	22,0	50,0

// R1E12M907M

90° connector

DIN 24° Male - BSPT Male

Heavy Series

Complete

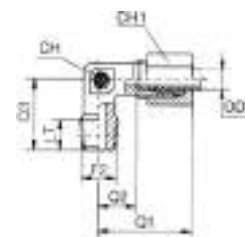

Item Code	Product Code	OD1	F2	Q1 (mm)	Q2 (mm)	Q3 (mm)	LT (mm)	CH (mm)	CH1 (mm)
1245026	R1A12M907M-0604_A	6	1/4-19	31,0	16,0	26,0	12,0	12,0	17,0
1245027	R1A12M907M-0804_A	8	1/4-19	32,0	17,0	27,0	12,0	14,0	19,0
1245028	R1A12M907M-1006_A	10	3/8-19	34,0	17,5	28,0	12,0	17,0	22,0
1245029	R1A12M907M-1206_A	12	3/8-19	38,0	21,5	31,0	12,0	17,0	24,0
1245030	R1A12M907M-1208_A	12	1/2-14	39,0	22,5	32,0	14,0	19,0	24,0
1245031	R1A12M907M-1408_A	14	1/2-14	40,0	22,0	32,0	14,0	19,0	27,0
1245032	R1A12M907M-1606_A	16	3/8-19	43,0	24,5	32,0	12,0	24,0	30,0
1245033	R1A12M907M-1608_A	16	1/2-14	43,0	24,5	32,0	14,0	24,0	30,0
1245034	R1A12M907M-2012_A	20	3/4-14	48,0	26,5	42,0	16,0	27,0	36,0
1245035	R1A12M907M-2516_A	25	1-11	54,0	30,0	48,0	18,0	36,0	46,0
1245036	R1A12M907M-3020_A	30	1 1/4-11	62,0	35,5	54,0	20,0	41,0	50,0
1245037	R1A12M907M-3824_A	38	1 1/2-11	72,0	41,0	61,0	22,0	50,0	60,0

// R1A11MT07M

Branch Tee connector

DIN 24° Male - BSPT Male

Light Series

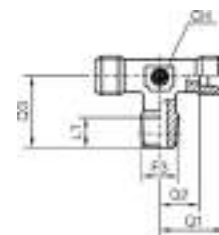

Item Code	Product Code	OD1	F2	Q1 (mm)	Q2 (mm)	Q3 (mm)	LT (mm)	CH (mm)
1206237	R1A11MT07M-0602	6	M12X1.5	19,0	12,0	20,0	8,0	12,0
1205794	R1A11MT07M-0804	8	M14X1.5	21,0	14,0	26,0	12,0	12,0
1205795	R1A11MT07M-1004	10	M16X1.5	22,0	15,0	27,0	12,0	14,0
1205796	R1A11MT07M-1206	12	M18X1.5	24,0	17,0	28,0	12,0	17,0
1206123	R1A11MT07M-1508	15	M22X1.5	28,0	21,0	34,0	14,0	19,0
1206238	R1A11MT07M-1808	18	M26X1.5	31,0	23,5	36,0	14,0	24,0
1206124	R1A11MT07M-2212	22	M30X2	35,0	27,5	42,0	16,0	27,0
1207819	R1A11MT07M-2816	28	M36X2	38,0	30,5	48,0	18,0	36,0
1207820	R1A11MT07M-3520	35	M45X2	45,0	34,5	54,0	20,0	41,0
1207821	R1A11MT07M-4224	42	M52X2	51,0	40,0	61,0	22,0	50,0

Design and dimensions shown may be changed without prior notice

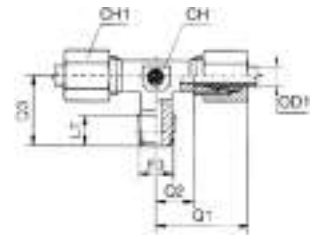
// R1E11MT07M**Branch Tee connector****DIN 24° Male - BSPT Male****Light Series****Complete**

Item Code	Product Code	OD1	F3	Q1 (mm)	Q2 (mm)	Q3 (mm)	LT (mm)	CH (mm)	CH1 (mm)
1244980	R1A11MT07M-0602_A	6	1/8-28	27,0	12,0	20,0	8,0	12,0	14,0
1242713	R1A11MT07M-0804_A	8	1/4-19	29,0	14,0	26,0	12,0	12,0	17,0
1244981	R1A11MT07M-1004_A	10	1/4-19	30,0	15,0	27,0	12,0	14,0	19,0
1244982	R1A11MT07M-1206_A	12	3/8-19	32,0	17,0	28,0	12,0	17,0	22,0
1244983	R1A11MT07M-1508_A	15	1/2-14	36,0	21,0	34,0	14,0	19,0	27,0
1244984	R1A11MT07M-1808_A	18	1/2-14	40,0	23,5	36,0	14,0	24,0	32,0
1244985	R1A11MT07M-2212_A	22	3/4-14	44,0	27,5	42,0	16,0	27,0	36,0
1244986	R1A11MT07M-2816_A	28	1-11	47,0	30,5	48,0	18,0	36,0	41,0
1244987	R1A11MT07M-3520_A	35	1 1/4-11	56,0	34,5	54,0	20,0	41,0	50,0
1244988	R1A11MT07M-4224_A	42	1 1/2-11	63,0	40,0	61,0	22,0	50,0	60,0

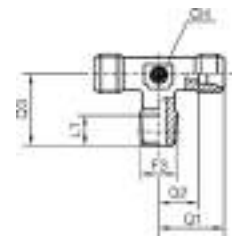
// R1A12MT07M**Branch Tee connector****DIN 24° Male - BSPT Male****Heavy Series**

Item Code	Product Code	OD1	F3	Q1 (mm)	Q2 (mm)	Q3 (mm)	LT (mm)	CH (mm)	CH1 (mm)
1207028	R1A12MT07M-0604	6	1/4-19	23,0	16,0	26,0	12,0	12,0	12,0
1207029	R1A12MT07M-0804	8	1/4-19	24,0	17,0	27,0	12,0	14,0	14,0
1207030	R1A12MT07M-1006	10	3/8-19	25,0	17,5	28,0	12,0	17,0	17,0
1207031	R1A12MT07M-1206	12	3/8-19	29,0	21,5	31,0	12,0	17,0	17,0
1207851	R1A12MT07M-1408	14	1/2-14	30,0	22,0	32,0	14,0	19,0	19,0
1206239	R1A12MT07M-1608	16	1/2-14	33,0	24,5	32,0	14,0	24,0	24,0
1245394	R1A12MT07M-2012	20	3/4-14	37,0	26,5	42,0	16,0	27,0	27,0
1207852	R1A12MT07M-2516	25	1-11	42,0	30,0	48,0	18,0	36,0	36,0
1245395	R1A12MT07M-3020	30	1 1/4-11	49,0	35,5	54,0	20,0	41,0	41,0
1245396	R1A12MT07M-3824	38	1 1/2-11	49,0	41,0	61,0	22,0	50,0	50,0

// R1E12MT07M

Branch Tee connector
DIN 24° Male - BSPT Male
Heavy Series
Complete

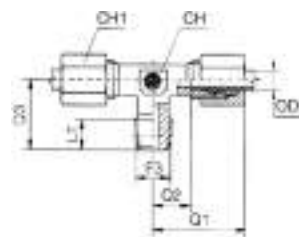

Item Code	Product Code	OD1	F3	Q1 (mm)	Q2 (mm)	Q3 (mm)	LT (mm)	CH (mm)	CH1 (mm)
1245048	R1A12MT07M-0604_A	6	1/4-19	31,0	16,0	26,0	12,0	12,0	17,0
1245049	R1A12MT07M-0804_A	8	1/4-19	32,0	17,0	27,0	12,0	14,0	19,0
1245050	R1A12MT07M-1006_A	10	3/8-19	34,0	17,5	28,0	12,0	17,0	22,0
1245051	R1A12MT07M-1206_A	12	3/8-19	38,0	21,5	31,0	12,0	17,0	24,0
1245052	R1A12MT07M-1408_A	14	1/2-14	40,0	22,0	32,0	14,0	19,0	27,0
1245053	R1A12MT07M-1608_A	16	1/2-14	43,0	24,5	32,0	14,0	24,0	30,0
1245397	R1A12MT07M-2012_A	20	3/4-14	48,0	26,5	42,0	16,0	27,0	36,0
1245054	R1A12MT07M-2516_A	25	1-11	54,0	30,0	48,0	18,0	36,0	46,0
1245398	R1A12MT07M-3020_A	30	1 1/4-11	62,0	35,5	54,0	20,0	41,0	50,0
1245399	R1A12MT07M-3824_A	38	1 1/2-11	72,0	41,0	61,0	22,0	50,0	60,0

// R1A11ML07M

Run Tee connector
DIN 24° Male - BSPT Male
Light Series



Item Code	Product Code	OD1	F2	Q1 (mm)	Q2 (mm)	Q3 (mm)	LT (mm)	CH (mm)
1206235	R1A11ML07M-0602	6	1/8-28	19,0	12,0	20,0	8,0	12,0
1211017	R1A11ML07M-0804	8	1/4-19	21,0	14,0	26,0	12,0	12,0
1206723	R1A11ML07M-1004	10	1/4-19	22,0	15,0	27,0	12,0	14,0
1206236	R1A11ML07M-1206	12	3/8-19	24,0	17,0	28,0	12,0	17,0
1206409	R1A11ML07M-1508	15	1/2-14	38,0	21,0	34,0	14,0	19,0
1211018	R1A11ML07M-1808	18	1/2-14	31,0	23,5	36,0	14,0	24,0
1244888	R1A11ML07M-2212	22	3/4-14	35,0	27,5	42,0	16,0	27,0
1244889	R1A11ML07M-2816	28	1-11	38,0	30,5	48,0	18,0	36,0
1207818	R1A11ML07M-3520	35	1 1/4-11	45,0	34,5	54,0	20,0	41,0
1244890	R1A11ML07M-4224	42	1 1/2-11	51,0	40,0	61,0	22,0	50,0

Design and dimensions shown may be changed without prior notice

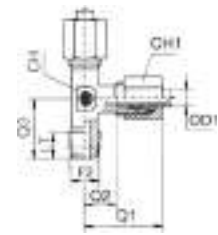
// R1E11ML07M**Run Tee connector****DIN 24° Male - BSPT Male****Light Series****Complete**

Item Code	Product Code	OD1	F2	Q1 (mm)	Q2 (mm)	Q3 (mm)	LT (mm)	CH (mm)	CH1 (mm)
1244970	R1A11ML07M-0602_A	6	1/8-28	27,0	12,0	20,0	8,0	12,0	14,0
1244971	R1A11ML07M-0804_A	8	1/4-19	29,0	14,0	26,0	12,0	12,0	17,0
1244972	R1A11ML07M-1004_A	10	1/4-19	30,0	15,0	27,0	12,0	14,0	19,0
1244973	R1A11ML07M-1206_A	12	3/8-19	32,0	17,0	28,0	12,0	17,0	22,0
1244974	R1A11ML07M-1508_A	15	1/2-14	36,0	21,0	34,0	14,0	19,0	27,0
1244975	R1A11ML07M-1808_A	18	1/2-14	40,0	23,5	36,0	14,0	24,0	32,0
1244976	R1A11ML07M-2212_A	22	3/4-14	44,0	27,5	42,0	16,0	27,0	36,0
1244977	R1A11ML07M-2816_A	28	1-11	47,0	30,5	48,0	18,0	36,0	41,0
1244978	R1A11ML07M-3520_A	35	1 1/4-11	56,0	34,5	54,0	20,0	41,0	50,0
1244979	R1A11ML07M-4224_A	42	1 1/2-11	63,0	40,0	61,0	22,0	50,0	60,0

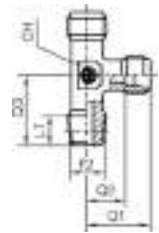
// R1A12ML07M**Run Tee connector****DIN 24° Male - BSPT Male****Heavy Series**

Item Code	Product Code	OD1	F2	Q1 (mm)	Q2 (mm)	Q3 (mm)	LT (mm)	CH (mm)	CH1 (mm)
1211204	R1A12ML07M-0604	6	1/4-19	23,0	16,0	26,0	12,0	12,0	12,0
1211205	R1A12ML07M-0804	8	1/4-19	24,0	17,0	27,0	12,0	14,0	14,0
1207847	R1A12ML07M-1006	10	3/8-19	25,0	17,5	28,0	12,0	17,0	17,0
1207848	R1A12ML07M-1206	12	3/8-19	29,0	21,5	31,0	12,0	17,0	17,0
1211206	R1A12ML07M-1408	14	1/2-14	30,0	22,0	32,0	14,0	19,0	19,0
1207849	R1A12ML07M-1608	16	1/2-14	33,0	24,5	32,0	14,0	24,0	24,0
1207850	R1A12ML07M-2012	20	3/4-14	37,0	26,5	42,0	16,0	27,0	27,0
1244910	R1A12ML07M-2516	25	1-11	42,0	30,0	48,0	18,0	36,0	36,0
1244911	R1A12ML07M-3020	30	1 1/4-11	49,0	35,5	54,0	20,0	41,0	41,0
1244912	R1A12ML07M-3824	38	1 1/2-11	57,0	41,0	61,0	22,0	50,0	50,0

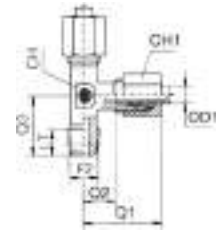
// R1E12ML07M**Run Tee connector****DIN 24° Male - BSPT Male****Heavy Series****Complete**

Item Code	Product Code	OD1	F2	Q1 (mm)	Q2 (mm)	Q3 (mm)	LT (mm)	CH (mm)	CH1 (mm)
1245038	R1A12ML07M-0604_A	6	1/4-19	31,0	16,0	26,0	12,0	12,0	17,0
1245039	R1A12ML07M-0804_A	8	1/4-19	32,0	17,0	27,0	12,0	14,0	19,0
1245040	R1A12ML07M-1006_A	10	3/8-19	34,0	17,5	28,0	12,0	17,0	22,0
1245041	R1A12ML07M-1206_A	12	3/8-19	38,0	21,5	31,0	12,0	17,0	24,0
1245042	R1A12ML07M-1408_A	14	1/2-14	40,0	22,0	32,0	14,0	19,0	27,0
1245043	R1A12ML07M-1608_A	16	1/2-14	43,0	24,5	32,0	14,0	24,0	30,0
1245044	R1A12ML07M-2012_A	20	3/4-14	48,0	26,5	42,0	16,0	27,0	36,0
1245045	R1A12ML07M-2516_A	25	1-11	54,0	30,0	48,0	18,0	36,0	46,0
1245046	R1A12ML07M-3020_A	30	1 1/4-11	62,0	35,5	54,0	20,0	41,0	50,0
1245047	R1A12ML07M-3824_A	38	1 1/2-11	72,0	41,0	61,0	22,0	50,0	60,0

Design and dimensions shown may be changed without prior notice

// BUTT WELD

// R1A11M100S

Butt Weld straight coupling DIN 24°

Light Series

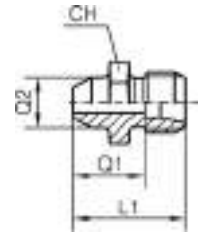

Item Code	Product Code	OD1	Q1 (mm)	Q2 (mm)	L1 (mm)	CH (mm)
1211088	R1A11M100S-0600	6	14,0	10,0	21,0	12,0
1211089	R1A11M100S-0800	8	16,0	12,0	23,0	14,0
1211090	R1A11M100S-1000	10	18,0	14,0	25,0	17,0
1211091	R1A11M100S-1200	12	18,0	16,0	25,0	19,0
1211092	R1A11M100S-1500	15	22,0	19,0	29,0	22,0
1211093	R1A11M100S-1800	18	23,5	22,0	31,0	27,0
1211094	R1A11M100S-2200	22	28,5	27,0	36,0	32,0
1211095	R1A11M100S-2800	28	30,5	32,0	38,0	41,0
1211096	R1A11M100S-3500	35	32,5	40,0	43,0	46,0
1210752	R1A11M100S-4200	42	35,0	46,0	46,0	55,0

// R1E11M100S

Butt Weld straight coupling DIN 24°

Light Series

Complete

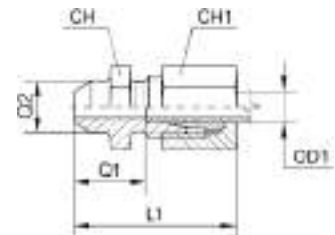

Item Code	Product Code	OD1	Q1 (mm)	Q2 (mm)	L1 (mm)	CH (mm)	CH1 (mm)
1243708	R1A11M100S-0600_A	6	14,0	10,0	29,0	12,0	14,0
1243709	R1A11M100S-0800_A	8	16,0	12,0	31,0	14,0	17,0
1243710	R1A11M100S-1000_A	10	18,0	14,0	33,0	17,0	19,0
1243711	R1A11M100S-1200_A	12	18,0	16,0	33,0	19,0	22,0
1243712	R1A11M100S-1500_A	15	22,0	19,0	37,0	22,0	27,0
1243713	R1A11M100S-1800_A	18	23,5	22,0	40,0	27,0	32,0
1243714	R1A11M100S-2200_A	22	28,5	27,0	45,0	32,0	36,0
1243715	R1A11M100S-2800_A	28	30,5	32,0	47,0	41,0	41,0
1243716	R1A11M100S-3500_A	35	32,5	40,0	54,0	46,0	50,0
1243717	R1A11M100S-4200_A	42	35,0	46,0	58,0	55,0	60,0

// R1A12M100S

**Butt Weld straight coupling DIN 24°
Heavy Series**

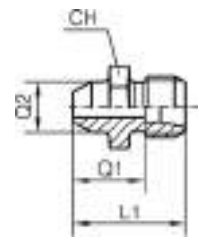

Item Code	Product Code	OD1	Q1 (mm)	Q2 (mm)	L1 (mm)	CH (mm)
1211265	R1A12M100S-0600	6	19,0	11,0	26,0	14,0
1211266	R1A12M100S-0800	8	21,0	13,0	28,0	17,0
1208074	R1A12M100S-1000	10	22,5	15,0	30,0	19,0
1206144	R1A12M100S-1200	12	24,5	17,0	32,0	22,0
1211267	R1A12M100S-1400	14	27,0	19,0	35,0	24,0
1211268	R1A12M100S-1600	16	26,5	21,0	35,0	27,0
1207100	R1A12M100S-2000	20	29,5	26,0	40,0	32,0
1208075	R1A12M100S-2500	25	32,0	31,0	44,0	41,0
1211269	R1A12M100S-3000	30	35,5	36,0	49,0	46,0
1207132	R1A12M100S-3800	38	38,0	44,0	54,0	55,0

// R1E12M100S

**Butt Weld straight coupling DIN 24°
Heavy Series
Complete**

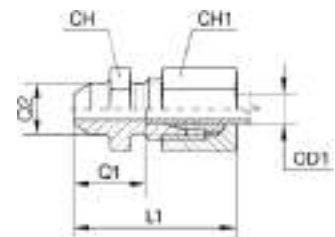

Item Code	Product Code	OD1	Q1 (mm)	Q2 (mm)	L1 (mm)	CH (mm)	CH1 (mm)
1244047	R1A12M100S-0600_A	6	19,0	11,0	34,0	14,0	17,0
1244048	R1A12M100S-0800_A	8	21,0	13,0	36,0	17,0	19,0
1244049	R1A12M100S-1000_A	10	22,5	15,0	39,0	19,0	22,0
1244050	R1A12M100S-1200_A	12	24,5	17,0	41,0	22,0	24,0
1244051	R1A12M100S-1400_A	14	27,0	19,0	45,0	24,0	27,0
1244052	R1A12M100S-1600_A	16	26,5	21,0	45,0	27,0	30,0
1244053	R1A12M100S-2000_A	20	29,5	26,0	51,0	32,0	36,0
1244054	R1A12M100S-2500_A	25	32,0	31,0	56,0	41,0	46,0
1244055	R1A12M100S-3000_A	30	35,5	36,0	62,0	46,0	50,0
1244056	R1A12M100S-3800_A	38	38,0	44,0	69,0	55,0	60,0

Design and dimensions shown may be changed without prior notice

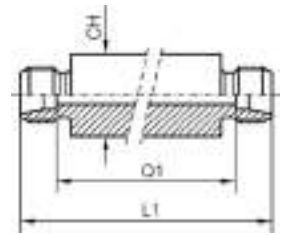
// R1A11M111S**Butt Weld long straight coupling DIN 24°****Light Series**

Item Code	Product Code	OD1	Q1 (mm)	L1 (mm)	CH (mm)
1211098	R1A11M111S-0606	6	56,0	70,0	18,0
1211099	R1A11M111S-0808	8	56,0	70,0	20,0
1211100	R1A11M111S-1010	10	58,0	72,0	22,0
1211101	R1A11M111S-1212	12	58,0	72,0	25,0
1207460	R1A11M111S-1515	15	70,0	84,0	28,0
1211102	R1A11M111S-1818	18	69,0	84,0	32,0
1211103	R1A11M111S-2222	22	73,0	88,0	36,0
1211104	R1A11M111S-2828	28	73,0	88,0	40,0
1211105	R1A11M111S-3535	35	71,0	92,0	50,0
1211106	R1A11M111S-4242	42	70,0	92,0	60,0

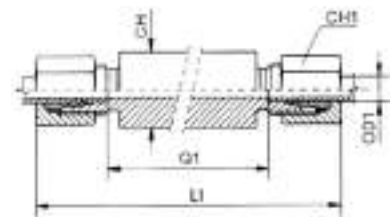
// R1E11M111S**Butt Weld long straight coupling DIN 24°****Light Series****Complete**

Item Code	Product Code	OD1	Q1 (mm)	L1 (mm)	CH (mm)	CH1 (mm)
1243787	R1A11M111S-0606_A	6	56,0	85,0	18,0	14,0
1243788	R1A11M111S-0808_A	8	56,0	85,0	20,0	17,0
1243789	R1A11M111S-1010_A	10	58,0	87,0	22,0	19,0
1243790	R1A11M111S-1212_A	12	58,0	87,0	25,0	22,0
1244547	R1A11M111S-1515_A	15	70,0	100,0	28,0	27,0
1243791	R1A11M111S-1818_A	18	69,0	101,0	32,0	32,0
1243792	R1A11M111S-2222_A	22	73,0	105,0	36,0	36,0
1243793	R1A11M111S-2828_A	28	73,0	106,0	40,0	41,0
1243794	R1A11M111S-3535_A	35	71,0	114,0	50,0	50,0
1243795	R1A11M111S-4242_A	42	70,0	115,0	60,0	60,0

// R1A12M112S

Butt Weld long straight coupling DIN 24°
Heavy Series

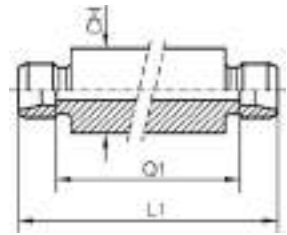

Item Code	Product Code	OD1	Q1 (mm)	L1 (mm)	CH (mm)
1211271	R1A12M112S-0606	6	60,0	74,0	20,0
1211272	R1A12M112S-0808	8	60,0	74,0	22,0
1208076	R1A12M112S-1010	10	59,0	74,0	252,0
1211273	R1A12M112S-1212	12	59,0	74,0	28,0
1211274	R1A12M112S-1414	14	72,0	88,0	30,0
1211275	R1A12M112S-1616	16	71,0	88,0	35,0
1207467	R1A12M112S-2020	20	71,0	92,0	38,0
1211276	R1A12M112S-2525	25	72,0	96,0	45,0
1211277	R1A12M112S-3030	30	73,0	100,0	50,0
1211278	R1A12M112S-3838	38	72,0	104,0	60,0

// R1E12M112S

Butt Weld long straight coupling DIN 24°
Heavy Series
Complete

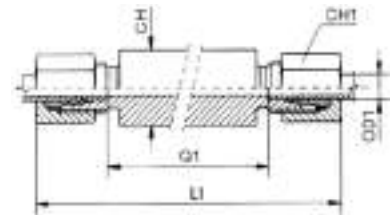

Item Code	Product Code	OD1	Q1 (mm)	L1 (mm)	CH (mm)	CH1 (mm)
1244135	R1A12M112S-0606_A	6	60,0	89,0	20,0	17,0
1244136	R1A12M112S-0808_A	8	60,0	89,0	22,0	19,0
1244137	R1A12M112S-1010_A	10	59,0	91,0	25,0	22,0
1244138	R1A12M112S-1212_A	12	59,0	91,0	28,0	24,0
1244139	R1A12M112S-1414_A	14	72,0	107,0	30,0	27,0
1244140	R1A12M112S-1616_A	16	71,0	107,0	35,0	30,0
1242452	R1A12M112S-2020_A	20	71,0	114,0	38,0	36,0
1244141	R1A12M112S-2525_A	25	72,0	120,0	45,0	46,0
1244142	R1A12M112S-3030_A	30	73,0	126,0	50,0	50,0
1244143	R1A12M112S-3838_A	38	72,0	133,0	60,0	60,0

Design and dimensions shown may be changed without prior notice

// PLUG

// R1A15F0000

Plug with O-Ring DIN 24°

Light Series

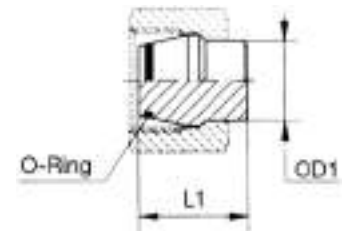

Item Code	Product Code	OD1	L1 (mm)
1208264	R1A15F0000-0600	6	18,5
1208263	R1A15F0000-0800	8	18,5
1208262	R1A15F0000-1000	10	20,0
1208240	R1A15F0000-1200	12	20,5
1208142	R1A15F0000-1500	15	20,5
1208143	R1A15F0000-1800	18	22,5
1208146	R1A15F0000-2200	22	25,0
1208148	R1A15F0000-2800	28	25,5
1208149	R1A15F0000-3500	35	30,0
1208150	R1A15F0000-4200	42	30,0

// R1A16F0000

Plug with O-Ring DIN 24°

Heavy Series

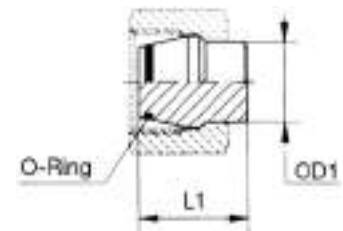

Item Code	Product Code	OD1	L1 (mm)
1208239	R1A16F0000-0600	6	18,5
1208238	R1A16F0000-0800	8	18,5
1208237	R1A16F0000-1000	10	20,0
1208236	R1A16F0000-1200	12	20,5
1208062	R1A16F0000-1400	14	22,5
1208063	R1A16F0000-1600	16	23,5
1208064	R1A16F0000-2000	20	28,5
1208065	R1A16F0000-2500	25	29,0
1208066	R1A16F0000-3000	30	30,5
1208067	R1A16F0000-3800	38	33,0

// R1A50I0000

Socket head plug Metric cylindric with elastomer

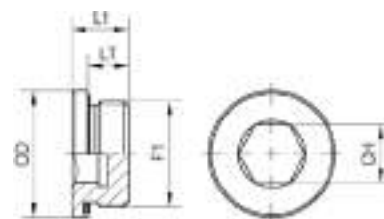

Item Code	Product Code	F1	Q1 (mm)	LT (mm)	L1 (mm)	CH (mm)
1246636	R1A50I0000-1000	M10X1.0	13,9	8,0	12,0	5,0
1248040	R1A50I0000-1200	M12X1.5	16,9	12,0	17,0	6,0
1246693	R1A50I0000-1400	M14X1.5	18,9	12,0	17,0	6,0
1248041	R1A50I0000-1600	M16X1.5	21,9	12,0	17,0	8,0
1204053	R1A50I0000-1800	M18X1.5	23,9	12,0	17,0	8,0
1247648	R1A50I0000-2000	M20X1.5	25,9	14,0	19,0	10,0
1246067	R1A50I0000-2200	M22X1.5	26,9	14,0	19,0	10,0
1246594	R1A50I0000-2600	M26X1.5	31,9	16,0	21,0	12,0
1204057	R1A50I0000-2700	M27X2	31,9	16,0	21,0	12,0
1206706	R1A50I0000-3300	M33X2.0	39,9	16,0	22,5	17,0
1211886	R1A50I0000-4200	M42X2	49,9	16,0	22,5	22,0
1207864	R1A50I0000-4800	M48X2.0	54,9	16,0	22,5	24,0

// R1A06I0000

Socket head plug BSPP cylindric with elastomer

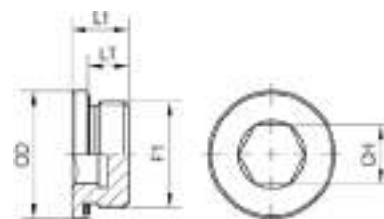

Item Code	Product Code	F1	Q1 (mm)	LT (mm)	L1 (mm)	CH (mm)
1204044	R1A06I0000-0200	1/8-28	13,9	8,0	12,0	5,0
1204043	R1A06I0000-0400	1/4-19	18,9	12,0	17,0	6,0
1204049	R1A06I0000-0600	3/8-19	21,9	12,0	17,0	8,0
1204042	R1A06I0000-0800	1/2-14	26,9	14,0	19,0	10,0
1204048	R1A06I0000-1200	3/4-14	31,9	16,0	21,0	12,0
1204045	R1A06I0000-1600	1-11	39,9	16,0	22,5	17,0
1204047	R1A06I0000-2000	1 1/4-11	49,9	16,0	22,5	22,0
1204046	R1A06I0000-2400	1 1/2-11	54,9	16,0	22,5	24,0

// HOSE GUIDELINE

SETTING NEW STANDARD

Alfagomma cares for the environment and for your equipment among Alfagomma's newest products are ALFABIOTECH 2000, 3000, 4000, 5000, 5000 PLUS, 6000 spiral hose, low temperature, Temp Tech, MineTuff, SuperTuff hose and a complete coupling line (two pieces and precrimped ALFAC-RIMP systems).

They join the extensive range of Alfagomma hose, the high pressure hydraulic components that have set the standard for reliability and durability.

DESIGN

Throughout the world, Alfagomma has built up a name synonymous with quality, a reputation based on first class product, a commitment to research and development and ongoing capital investment.

The development and product engineering staff in Alfagomma, continue to provide fluid conveying product innovations that assure better performance and cost saving to our customers.

Alfagomma hose and couplings are designed to work together as a system for problem free performance, no matter what machine you operate.

The performance of all our products exceeds SAE, DIN, JIS requirements and some hoses meet the MSHA and LOBA flame resistance requirements, as well.

LEADERSHIP IN HYDRAULIC HOSE AND COUPLING COMPONENTS

Alfagomma has developed into a world leading manufacturer of fluid power and fluid system components. A positive attitude towards the demands of new equipment which is using the latest technology has seen Alfagomma introduce many outstanding new hydraulic hose types. These hoses have found acceptance in a wide range of industries, some examples are: Mining, Logging, Petroleum, Railroad, Construction, Earthmoving, Agriculture, Waste/Refuse, Manufacturing, Pulp and Plywood Mills, Moulding, Drilling, Crane

GLOBAL COMPANY

Due to our world-wide organisation of subsidiaries and distributors you will always be near a source for Alfagomma products. Your Alfagomma dealer has trained personnel to consult with you on your hose and coupling requirements guaranteeing consistent quality and performance.

OUR COMMITMENT

By remaining alert to customer's needs, Alfagomma is constantly engineering new products for tomorrow's markets as well as modifying them for even higher performances.

Alfagomma commitment to innovation and service makes our products known throughout the world for quality, reliability and leadership, when you need quality hose and couplings, use the best available.

Now you can count on Alfagomma for all your needs.

TESTING

Alfagomma laboratories are fully equipped to carry out tests according to standards like SAE, ISO, DIN and JIS. New products are also subjected to laboratory simulation of actual service prior to being released on the market.

WORLD CLASS QUALITY

Alfagomma is working to adhere to internationally recognised quality programmes requiring stringent standards.

Many of our customers are demanding ISO qualification or equivalent as a prerequisite for purchasing. This standard is an assurance of consistent quality. For Alfagomma this is just the start "do it right from the beginning".

IMPORTANT NOTE FOR USERS

Hose assemblies require caution in use not only to provide long service life but also to guard against potentially dangerous failure.

Serious injury, death and destruction of property can result from the rupture or blowing-apart of a hydraulic hose assembly that is damaged, worn out, badly assembled or installed incorrectly.

Users should follow good maintenance practices. Avoid expensive downtime by establishing a program of inspection, testing and replacement of hose assemblies before failure occurs; taking into account factors including: severity of application, frequency of equipment use, past performance of hose assemblies. Document your maintenance, inspections and testing.

Only properly trained persons should inspect, test or service hose assemblies and this training should be updated regularly.

Users should carefully observe the precautions listed below under "be aware that" as well as follow closely our recommendations for the selection of hose and couplings. In addition, care should be taken not to exceed the minimum bend radius listed for each hose size and type.

Maximum operating pressure should not exceed the pressures listed. Instruction for assembling fittings to different hoses should be followed carefully to ensure the safe performance of the complete assembly.

By following the recommendations on hose assembly routing and installation, improved safety and longer service life of any hose installation will result.

Hydraulic fluid under pressure can be potentially dangerous!! An explosive burst or stream of escaping fluid can cause damage to equipment as well as serious injury to persons nearby.

BE AWARE THAT...

1. Highly pressurised fluid escaping from a small pinhole can be almost invisible and, yet, exert extreme force capable of penetrating the skin and other body tissues, causing possible severe injury.
2. Hot fluids or chemicals can cause severe burns.
3. Pressurised fluids, if released uncontrolled, can exert a tremendous explosive force.
4. All hydraulic hoses listed in this catalogue are electrically conductive.
5. Some hydraulic fluids are highly flammable.

AND...

6. Always position a shield between you and any pressurised hydraulic lines when working next to them... or shut the pressure off.
7. Wear safety glasses.
8. Do not use your hands to check for leaks. Do not touch a pressurised hydraulic hose assembly with any part of your body, if fluid punctures the skin, even if no pain is felt, a serious emergency exists. Obtain medical assistance immediately. Failure to do so can result in loss of the injured body part or death.
9. Stay out of hazardous areas while testing hose assemblies under pressure. Use proper safety protection.
10. If an injury or reaction occurs, get medical attention right away.
11. Use only non conductive thermoplastic hoses where electrical conductivity is not desired: for instance, equipment working on electric power lines.

Alfagomma hose and fitting are designed, engineered and tested to be used together in an assembly.

The use of Alfagomma fittings on other manufactures hose or the use of Alfagomma hose with other manufactures fittings may result in the production of unreliable or unsafe assemblies. It is neither recommended nor authorised by Alfagomma.

Alfagomma recommends only those hose and coupling combinations specified in the Alfagomma Hydraulic Products Catalogues.

Alfagomma disclaims any liability for any hose assemblies which have not been produced in conformance with Alfagomma assembly recommendations and current crimp data charts. Extensive impulse testing has been performed by Alfagomma to verify the recommendations contained in this catalogue. A simple burst or pressure test cannot determine a hose and coupling combination.

Any claim for defects must be made in writing on the appropriate ISO 9001 complaint form within 8 days from receipt of the product. Alfagomma will have a reasonable opportunity thereafter to examine and investigate the alleged defect.

The customer's exclusive remedy with respect to any claim of any kind whatsoever shall be refund of the purchase price or replacement of the product at the option of Alfagomma and in no event shall Alfagomma be liable for any incidental or consequential damages whatsoever.

REFERENCE SPECIFICATIONS

SAE	Society of Automotive Engineers
DNV-GL	Det Norske Veritas - Germanischer Lloyd
EN	European Norm
DIN	Deutsche Institute Normen
CERCHAR	Centre d'Etudes et Recherches des Charbonnages de France
MSHA	U.S. Mine Safety and Health Administration

LOBA	Landesobergamnt Nordrhein - Westfalen
AS	Australian Standard
BV	Bureau Veritas
ISO	International organization for Standardization
KR	Korean Register
MA	Chinese Mining

The listings below are intended only as guides in identifying which Alfagomma hoses comply with requirements of various agencies.

Hose	SAE J517	EN	ISO	Alfagomma proprietary hose	DNV GL	ABS	BV	NKK	RINA	Lloyd's Register	MSHA ²	USDOT ³	KR	MA
Argus 1TE/R6 HF	100 R6	EX 854 1TE (up to 3/4")												
Argus 2TE HF		854 2TE												
Argus 3TE/R3 HF	100 R3	854 3TE												
Flexor R4	100 R4						●							
Flexor 5	100 R5											●		
Flexor 7	100 R7	855 R7	3949											
Flexor 8	100 R8	855 R8												
Flexor 1SN-R1AT HF	100 R1AT	853 1SN	1436-1		●	●				●			●	
Flexor 1SN-R1AT MT	100 R1AT	853 1SN			●	●				●	●			
Flexor 2SN-R2AT HF	100 R2AT	853 2SN	1436-1		●	●			●	●			●	
Flexor 2SN-R2AT MT	100 R2AT	853 2SN			●	●			●	●	●			●
Flexopak PLT				●										
Flexopak 1SC		857 1SC	11237		●		●							
Flexopak 2 MT	100 R16	857 2SC	11237	●	●	●	●	●	●	●	●		●	
Flexopak 2SC HF	100 R16	857 2SC	11237		●	●	●							●
2TE Railway		854 2TE 45545-2												
2SC Railway		854 2SC 45545-2	11237											
Flexor Elevator		81.20												
Alfabiotech 2000			18752								●			
Alfabiotech 3000	EX SAE R12		18752 (up to 2 1/2")	●	●	●	●	●	●	●	●			
Alfabiotech 4000			18752	●	●	●	●	●	●	●	●		●	
Alfabiotech 5000			18752	●	●	●	●	●	●	●	●		●	
Alfabiotech 5000 PLUS			18752	●	●	●	●	●	●	●	●		●	
Alfabiotech 6000	EX SAE R15		18752	●	●	●	●	●	●	●	●		●	
Alfabiotech Evolution 2000			18752								●			
Alfabiotech Evolution 3000	EX SAE R12		18752 (up to 2 1/2")	●	●	●	●	●	●	●	●			
Alfabiotech Evolution 4000			18752	●	●	●	●	●	●	●	●		●	
Alfabiotech Evolution 5000			18752	●	●	●	●	●	●	●	●		●	
Alfabiotech Evolution 5000 PLUS			18752	●	●	●	●	●	●	●	●		●	
Alfabiotech Evolution 6000	EX SAE R15		18752	●	●	●	●	●	●	●	●		●	
Evolution 4000 LT			18752											
Evolution 5000 LT			18752											
Evolution 6000 LT			18752											
Firesafe 5000				●	●					●	●			
AT3K - MT	100 R17	857 (up to 3/8")	11237	●		●					●			
AT7K - MT				●							●			
AT8K - MT				●							●			
1SN Evolution HT 150	100 R1AT	853 1SN	1436-1	●							●			
2SN Evolution HT 150	100 R2AT	853 2SN	1436-1	●							●			
Flexopak 2 LT	100 R16	857 2SC		●										
Alfaforest				●										
Alfajet 210				●										
Alfajet 400				●										

* Running

1. DNV approvals are with permanent (crimp) type fittings only
2. Hoses with MSHA approved cover are always branded "MSHA"
3. DOT Type all TYPE AII FMVSS 106 approval up to 3/4"

Listing may vary by style and size, for current and complete information, contact Alfagomma for details.

SAFETY GUIDE BASIC FACTORS FOR THE SELECTION, INSTALLATION AND MAINTENANCE OF HOSE AND HOSE ASSEMBLIES

Hydraulic hose (and hose assemblies) has a limited life dependent on service conditions to which is applied. Subjecting hose (and hose assemblies) to conditions more severe than the recommended limits significantly reduce service life. Exposure to combinations of recommended limits (i.e., continuous use at maximum rated working pressure, maximum recommended operating temperature and minimum bend radius) will also reduce service life.

WARNING: FAILURE TO FOLLOW PROPER SELECTION, INSTALLATION AND MAINTENANCE PROCEDURES MIGHT RESULT IN BODILY INJURY, AND DAMAGE TO PROPERTY.

1. SELECTION

The following is a list of factors which must be considered before the selection of a hose can be made:

1.1 Line size

In order to achieve maximum efficiency in a hydraulic system, it is necessary to keep pressure losses (resistance to the volumetric flow) to a minimum when a fluid is conveyed by the different types of flow lines. When a fluid flows through a flow line, heat is generated by friction. Thus part of the energy is lost as heat energy, which results in a pressure loss.

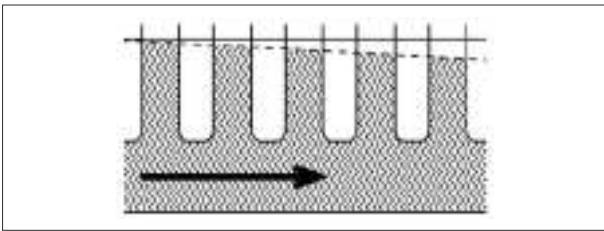

These pressure losses depend upon:

- flow velocity (for a given volumetric flow, the fluid flow velocity increases with a decrease in the cross sectional area of a flow line and vice versa)
- length of the flow line
- the viscosity of the fluid flowing
- the density of the fluid flowing
- the type of flow (laminar or turbulent)

Types of flow - The type of flow changes from laminar to turbulent at a certain flow velocity. This velocity is given by the Reynold's Number Re.

For cylindrical flow lines the following formula applies:

$$Re = \frac{v \times d}{\nu}$$

- where:
- v = velocity (m/s)
 - d = flow line internal dia (m)
 - ν = kinematic viscosity (m²/s)

As soon as the value for Re exceeds 2300, the laminar flow changes to turbulent flow.

Laminar flow - In laminar flow, the individual fluid particles move up to certain speeds in uniform layers alongside each other. They scarcely disturb or influence each other.

Turbulent flow - If the value for Re exceeds 2300, flow becomes whirling and turbulent. The individual particles no longer move in one direction in an orderly fashion, but influence and hinder each other.

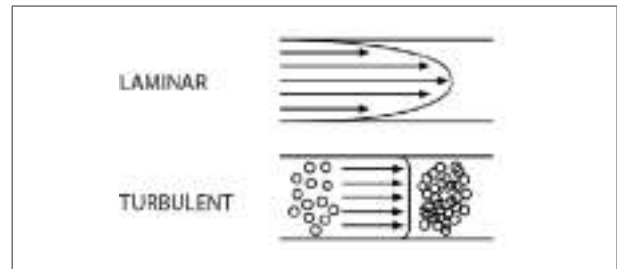

Certain fluid flow velocities have proved to be most suitable for hydraulic flow lines.

Recommended flow velocities:

Suction lines:	0.5 ... 1.2 m/s	1.6 ... 4 feet/s
Return lines:	2 ... 3 m/s	6.5 ... 10 feet/s
Pressure lines:	4 ... 7.5 m/s	13...25 feet/s

FLOW CAPACITY NORMOGRAM

Flow Capacities of Hose at Recommended Flow Velocities

The chart below is provided as an aid in the determination of the correct hose size.

Example at 45 l/min, what is the proper hose size within the recommended velocity range for pressure lines?

Locate 45 l/min in the left-hand column and 7,5 m/s in the right-hand column (the maximum recommended velocity range for pressure lines).

Lay a straight line across these two points. The inside diameters shown in the centre column is above 9,5 mm so we have to use 12,7 mm (1/2"). For suction hose, follow the same procedure except use recommended velocity range for intake lines in the righthand column.

- where:
- Q = flow in liters per seconds (l/sec)
 - V = velocity in meters per seconds (m/s)
 - d = hose inside diameter (mm & dash size)

TECHNICAL INFORMATION – NORMOGRAM OF THE FLOW

The normogram herewith is pivotal to help you find the hose diameter by knowing the liquid flow and speed. In order to find the correct diameter you should trace a line between the flow value (l/min) and the suggested speed (m/sec) according to the kind of delivery (pressure or return). The value touched by the line in the central column will indicate the hose ID (mm/inches) that must be used.

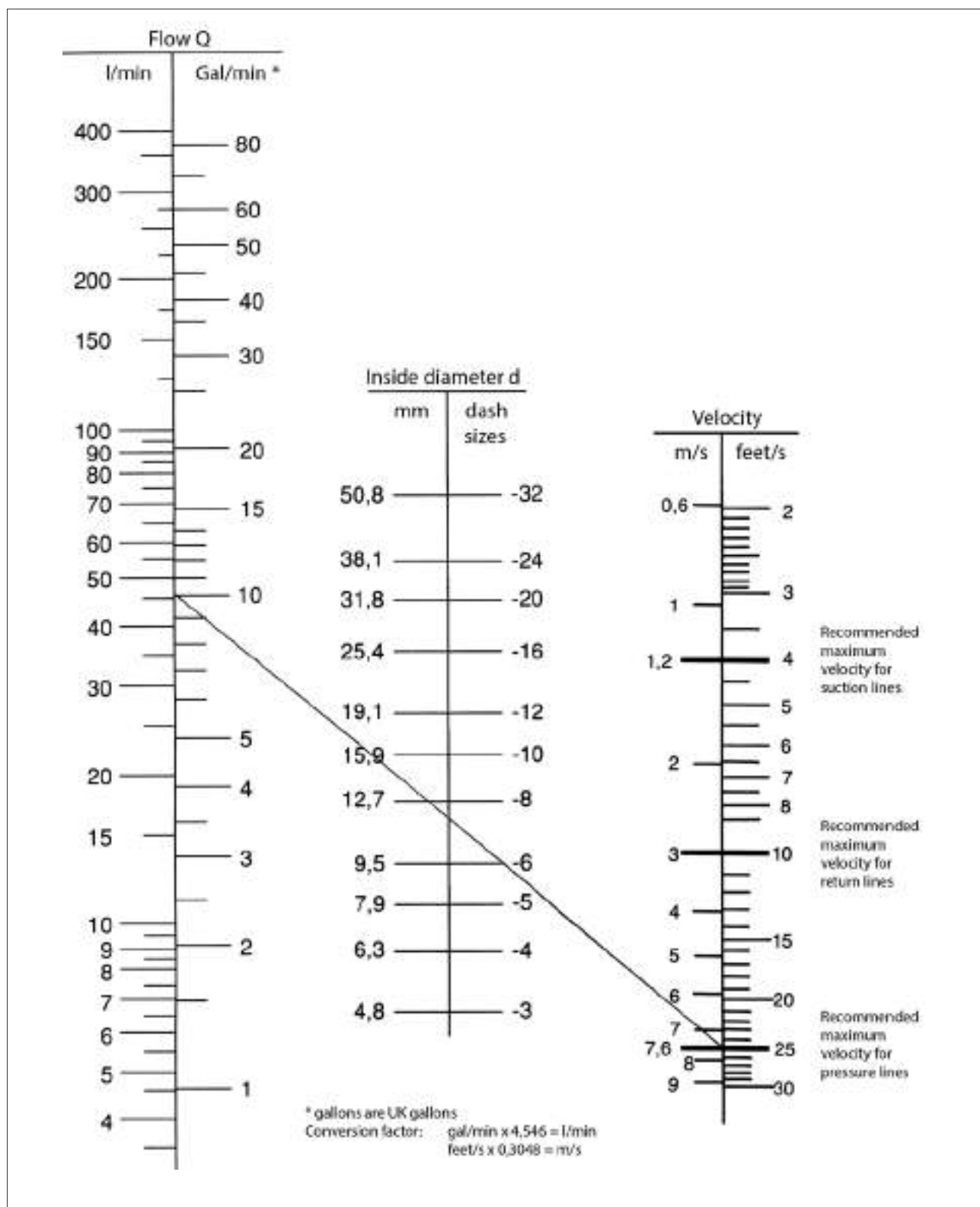

It is therefore important to calculate correctly the required flow line sizes. Undersized pressure lines results in high fluid velocity causing an excessive pressure drop, and heat built up, which impair overall system performance.

Undersized suction lines can cause cavitation at the hydraulic pump inlet, affecting performance, shortening pump life, and creating excessive noise levels.

The flow capacity normogram is an aid to determine the correct hose internal diameter size, desired flow rate and recommended velocity. By the use of any two known factors, the third can be determined.

1.2 Pressure

After determining the system pressure for a hydraulic system, hose selection must be made so that the recommended maximum operating pressure specified by a given hose, is equal or greater than the system pressure. Dynamic pressure is common for all hydraulic systems. Pressure surges which exceed the maximum working pressure (pressure relief valve setting) affect the service life of system components, including a hose assembly and therefore need to be taken into consideration. Hoses used for suction lines must be selected to ensure the hose will withstand the negative pressure of the system.

1.3 Temperature

Care must be taken to ensure that the operating temperature of the fluid being conveyed and ambient temperatures, do not exceed the limitations of the hose. Special care must be taken when routing near hot manifolds or molten metal.

1.4 Fluid Compatibility

Hose selection must assure compatibility of the hose tube, cover, reinforcement, and fittings with the fluid used.

Additional caution must be observed in hose selection for gaseous applications. Some fire resistant fluids require the same hose as petroleum oil. Some use a special hose, while a few fluids will not work with any hose at all.

For gas application, where compatible with Alfagomma Hoses, and at pressure above 10 bar, the hose cover shall be pin-pricked.

1.5 Permeation

Permeation (that is, seepage through the hose) will occur from inside the hose to outside when hose is used with gases, liquid and gas fuels, and refrigerants (including but not limited to such materials such as helium, fuel oil, natural gas or freon). This permeation may result in high concentrations of vapours which are potentially flammable, explosive, or toxic and in loss of fluid. Even though the fluid compatibility is acceptable, you must take into account the fact that permeation will occur and could be hazardous. Permeation of moisture from outside the hose to inside the hose will also occur. If this moisture permeation would have detrimental effects (particularly but not limited to refrigeration and air conditioning systems), incorporation of sufficient drying capacity in the system or other appropriate system safeguards should be selected and used.

1.6 Routing

Attention must be given to optimum routing to minimise inherent problems. Restrain, protect or guide hose with the use of clamps if necessary to minimise risk or damage due to excessive flexing, whipping or contact with other moving parts or corrosives. Determine hose lengths and configurations that will result in proper routing and protection from abrasion, snagging or kinking and provide leak resistant connections.

1.7 Environment

Care must be taken to ensure that the hose and fittings are either compatible with or protected from the environment to which they are exposed. Environmental conditions including

but not limited to ultraviolet light, heat, ozone, moisture, water, salt water, chemicals, and air pollutants can cause degradation and premature failure and, therefore, must be considered.

1.8 Mechanical Loads

External forces can significantly reduce hose life. Mechanical loads which must be considered include excessive flexing, twist, kinking, tensile or side loads, bend radius, and vibration. Use of swivel type fittings or adaptors may be required to ensure no twist is put into the hose. Unusual applications may require special testing prior to hose selection.

1.9 Abrasion

While a hose is designed with a reasonable level of abrasion resistance, care must be taken to protect the hose from excessive abrasion which can result in erosion, snagging, and cutting of the hose cover. Exposure of the reinforcement will significantly accelerate hose failure.

1.10 Proper End Fitting

Care must be taken to ensure proper compatibility exists between the hose and coupling selected based on the manufacturer's recommendations substantiated by testing to industry standards such as SAE J517, DIN 20024, JIS B 8360.

1.11 Length

When establishing proper hose length, motion absorption, hose length changes due to pressure, as well as hose and machine tolerances must be considered.

1.12 Specifications and Standards

When selecting hose and fittings, government, industry, and manufacturer's specifications and recommendations must be reviewed as applicable.

1.13 Hose Cleanliness

Hose components may vary in cleanliness levels. Care must be taken to ensure that the assemblies selected have an adequate level of cleanliness for the application.

1.14 Welding and Brazing

Heating of plated parts, including hose fittings and adaptors, above 232° C (450° F) such as during welding, brazing, or soldering may emit deadly gases.

1.15 Electrical Conductivity

Certain applications require that a hose be non-conductive to prevent electrical current flow. Other applications require the hose to be sufficiently conductive to drain off static electricity. Extreme care must be exercised when selecting hose and fittings for these or any other applications in which electrical conductivity or non-conductivity is a factor. For applications that require hose to be electrically non-conductive, including but not limited to applications near high voltage electric lines, only special non-conductive hose is to be used must be consulted to be certain that the hose and fittings that are selected are proper for the application.

Do not use any Alfagomma hose or fitting for any application requiring non-conductive hose, including but not limited to applications near high voltage electric lines, unless the application is expressly approved in the Alfagomma technical publication for the product, the SAFETY GUIDE hose is both orange in colour and marked "non-conductive", and the manufacturer of the equipment on which the hose is to be used specifically approves the particular Alfagomma hose and fitting for such use. Alfagomma does not supply any hose or fittings for conveying paint in airless paint spraying or similar applications and therefore should not be used. A special hose and fitting assembly is required for this application, to avoid static electricity buildup which could cause a spark that may

results in an explosion and/or fire. The electrical conductivity or non-conductivity of hose and fittings is dependant upon many factors and may be susceptible to change. These factors include but are not limited to the various materials used to make the hose and the fittings, manufacturing methods (including moisture control), how the fittings contact the hose, age and amount of deterioration or damage or other changes, moisture content of the hose at and particular time, and others factors.

2. INSTALLATION

After the selection of the correct hose, the following factors must be considered prior to hose and fitting assembly and installation.

2.1 Pre-Installation Inspection

Prior to installation, a careful examination of the hose must be performed. All components must be checked for correct style, size, and length. The hose must be examined for cleanliness, obstructions, blisters, cover looseness, or any other visible defects.

2.2 Hose and Fitting Assembly

Do not assemble an Alfagomma fitting on an Alfagomma hose that is not specified by Alfagomma for that hose. Do not assemble Alfagomma fittings on another manufacturer's hose or an Alfagomma hose on another manufacturer's fitting unless Alfagomma approves the assembly in writing, and the user verifies the assembly and the application through analysis and testing.

The Alfagomma published hose assembly instructions must be followed for assembling the fittings on the hose.

2.3 Related Accessories

Crimp or swage Alfagomma hose or fittings only with Alfagomma approved swage or crimp machines and in accordance with the Alfagomma published hose assembly instructions.

2.4 Parts

Do not use any Alfagomma hose fitting part (including but not limited to sockets, or inserts) except with the correct Alfagomma mating parts, in accordance with Alfagomma published hose assembly.

2.5 Reusable/Permanent

Do not reuse any reusable hose coupling that has blown or pulled off a hose. Do not reuse an Alfagomma permanent (that is, crimped or swaged) hose fitting or any part thereof.

2.6 Minimum Bend Radius

Installation of a hose at less than the minimum listed bend radius may significantly reduce the hose life. Particular attention must be given to avoid sharp bending at the hose/fitting juncture.

2.7 Twist Angle and Orientation

Hose installations must be such that relative motion of machine components does not produce twisting.

2.8 Securement

In many applications, it may be necessary to restrain, protect, or guide the hose to protect it from damage by unnecessary flexing, pressure surges, and contact with other mechanical components. Care must be taken to ensure such restraints do not introduce additional stress or wear points.

2.9 Proper Connection of Ports

Proper physical installation of the hose requires a correctly installed port connection while ensuring that no twist or torque is transferred to the hose.

2.10 External Damage

Proper installation is not complete without ensuring that tensile loads, side loads, kinking, flattening, potential abrasion, thread damage, or damage to sealing surfaces are corrected or eliminated.

2.11 System Checkout

After completing the installation all air entrapment must be eliminated and the system pressurised to the maximum system pressure and checked for proper function without any leaks. Personnel must stay out of potential hazardous areas while testing.

3. HOSE AND FITTING MAINTENANCE INSTRUCTIONS

Even with proper selection and installation, hose life may be significantly reduced without a continuing maintenance program. Frequency should be determined by the severity of the application and risk potential. A maintenance program must be established and followed to include the following as a minimum:

3.1 Visual Inspection Hose/Fitting

Any of the following conditions require immediate shut down and replacement of the hose assembly:

- Fitting slippage on hose.
- Damaged, cut or abraded cover (any reinforcement exposed).
- Hard, stiff, heat cracked, or charred hose.
- Cracked, damaged, or badly corroded fittings.
- Leaks at fitting or in hose.
- Kinked, crushed, flattened or twisted hose.
- Blistered, soft, degraded, or loose cover.

3.2 External Damage

Proper installation is not complete without ensuring that tensile loads, side loads, kinking, flattening, potential abrasion, thread damage, or damage to sealing surfaces are corrected or eliminated.

3.3 System Checkout

After completing the installation all air entrapment must be eliminated and the system pressurised to the maximum system pressure and checked for proper function without any leaks. Personnel must stay out of potential hazardous areas while testing.

3.4 Visual Inspection All Other

The following items must be tightened, repaired or replaced as required:

- Leaking port conditions
- Remove excess dirt build-up
- Clamp, guards, shields
- System fluid level, fluid type and any air entrapment

3.5 Functional Test

Operate the system at maximum operating pressure and check for possible malfunctions and freedom from leaks. Personnel must stay out of potential hazardous areas while testing.

3.6 Replacement Intervals

Specific replacement intervals must be considered based on previous service life, government or industry recommendations, or when failures could result in unacceptable downtime, damage, or injury risk.

CORRECT ASSEMBLY INSTALLATION

Satisfactory performance and appearance depend upon proper hose installation. Excessive length destroys the trim appearance of an installation and adds unnecessarily to the cost of the equipment. Hose assemblies of insufficient length to permit adequate flexing, expansion or contraction will cause poor power transmission and shorten the life of the hose. The diagrams below offer suggestions for proper hose installations to obtain the maximum in performance and economy.

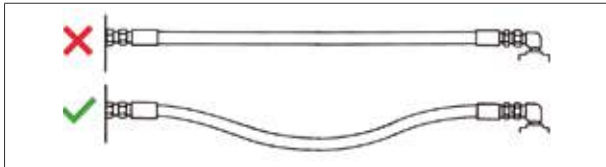

Since hose may change in length from +2% to -4% under the surge of high pressure, provide sufficient slack for expansion and contraction.



Avoid sharp twist or bend in hose by using proper angle adapters.



Where the radius falls below the required minimum, an angle adapter should be used as shown above to avoid sharp bends in hose.

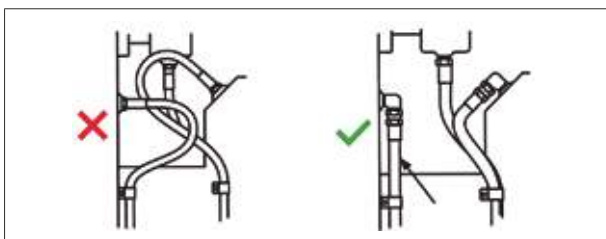

Obtain direct routing of hose through use of 45° and 90° adapters and fittings. Improve appearance by avoiding excessive hose length.

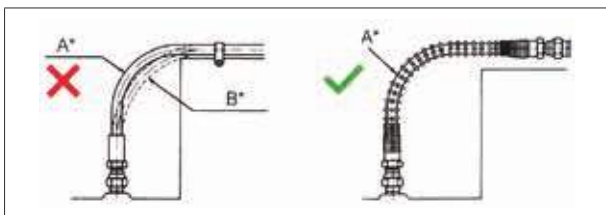

A: High Pressure - B: No Pressure

Due to changes in length when hose is pressurised, do not clamp at bends so curves absorb changes and protect the hose with a spring guard. Do not clamp high and low pressure lines together and protect the hose with a spring guard.

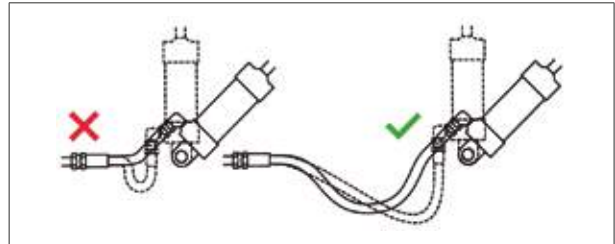

Adequate hose length is most important to distribute movement on flexing applications and to avoid abrasion.

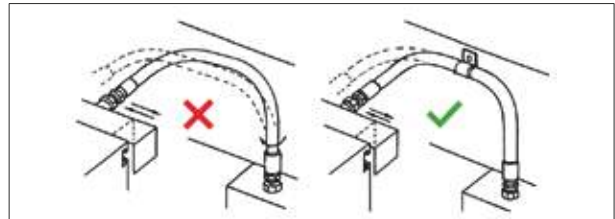

To avoid twisting in hose lines bent in two planes, clamp hose at change of plane, as shown.

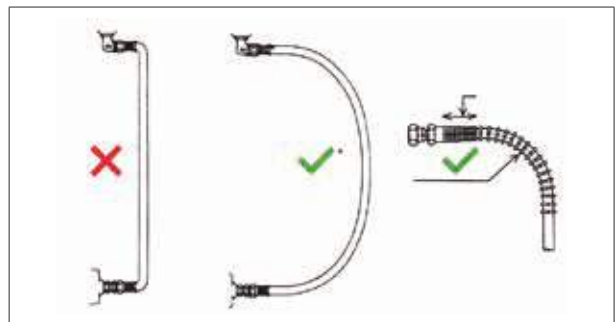

* Never use a banding radius less than the minimum amount shown in the table. To prevent twisting and distortion, hose should be bent in the same plane as the motion of the boss to which the hose is connected.

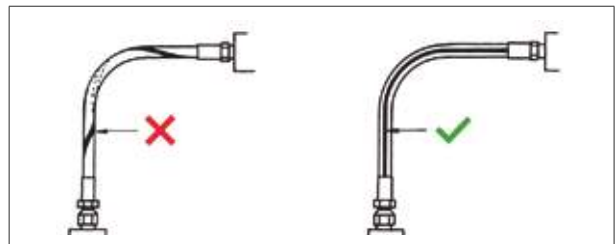

Hose should not be twisted. Hose is weakened when installed in twisted position. Also pressure in twisted hose tends to loosen fitting connections. Design so that machine motion produces bending rather than twisting.

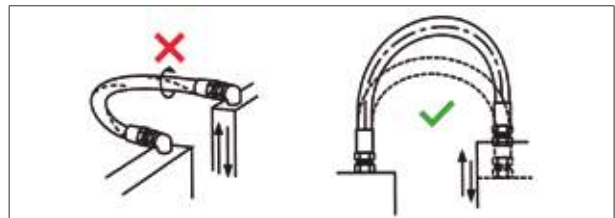

Never use a bending radius less than the minimum shown in the hose specification tables. Avoid sharp bend in hose to reduce collapsing of line and restriction of flow by using proper spring guard. Exceeding minimum bend radius will greatly reduce hose assembly life.

HOW TO DETERMINE CORRECT ASSEMBLY LENGTH

For most assemblies, the correct assembly length may be determined by direct measurement of the equipment or a drawing. Minimum bend radii as shown in the hose specification tables should be observed.

Assemblies are measured to the end of the seal.

To determine the length of hose needed in making assemblies with permanent or reusable couplings, subtract Dimension "C" (Cut off factor) for each coupling from the required overall assembly length. Dimension "C" may be found in the coupling specification tables.

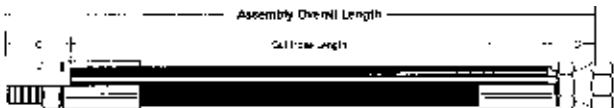

HOW TO MEASURE ASSEMBLIES

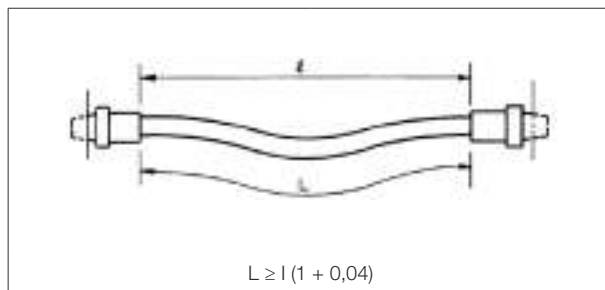
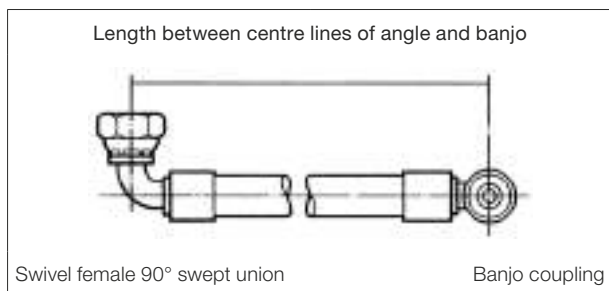
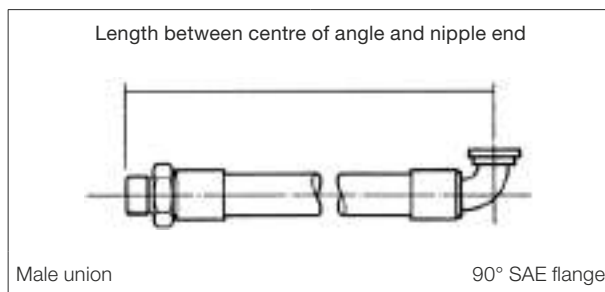
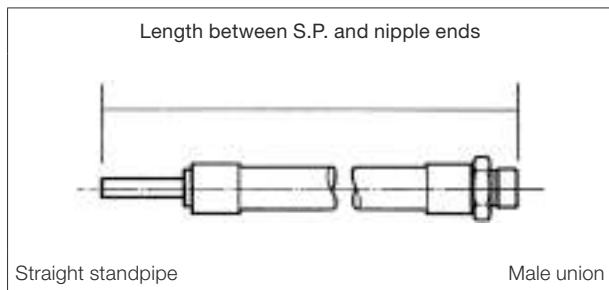
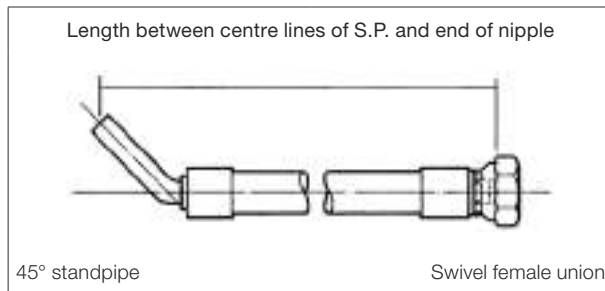
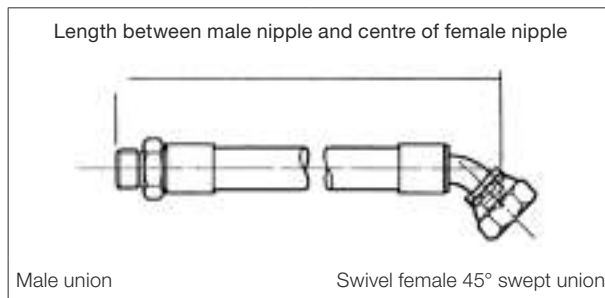
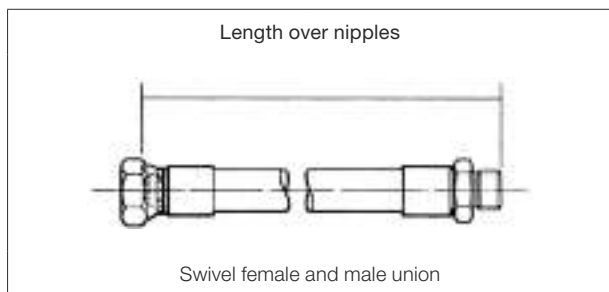

Remember that hydraulic hose under pressure will elongate up to 2% of its length or contract up to 4% depending on pressure, type and size. Sufficient allowance should be made to permit such changes in length.

Occasionally an assembly will be required similar to the sketches to the right. The following equations are helpful in determining the correct length:

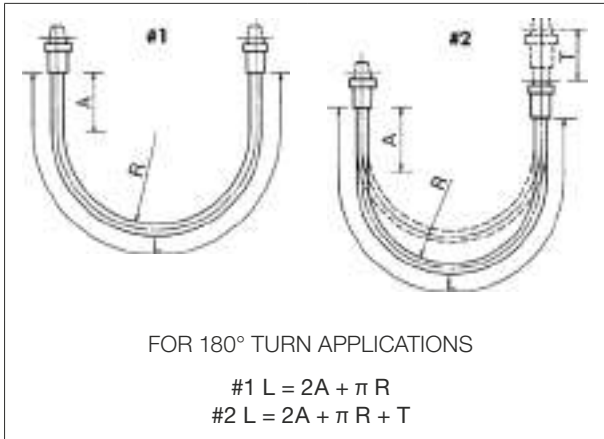

where:

L = overall length of the hydraulic hose assembly, in mm or inches.

A = allowance for a minimum straight section of hydraulic hose at each end of the assembly, measured from the outer end of each coupling, in mm or inches. These two straight sections are necessary to prevent excessive stress concentrations directly back of the couplings. See table below.

R = bending radius of the hose, in mm or inches. See hose specifications tables.

T = amount of travel, in mm or inches.

Often right angle adapters provide a convenient means of avoiding too small a bend radius.

Hose ID	in	1/4	5/16	3/8	1/2	5/8	3/4	1	1.1/4	1.1/2	2
	mm	6,4	7,9	9,5	12,7	15,9	19	25	31,8	38,1	50,8
Min "A"	in	5	5	5	6	6	7	8	9	10	11
	mm	127	127	127	152	152	178	203	229	254	279

Length Tolerance for Hydraulic Hose Assemblies and Specified Hose Lengths

For lengths from 0 up to and including 12" (305 mm)

Tolerance: $\pm 1/8" \pm 3 \text{ mm}$

For lengths $\geq 12" (305 \text{ mm}) < 18" (457 \text{ mm})$

Tolerance: $\pm 3/16" \pm 5 \text{ mm}$

For lengths $\geq 18" (457 \text{ mm}) < 36" (914 \text{ mm})$

Tolerance: $\pm 1/4" \pm 6 \text{ mm}$

For lengths $\geq 36" (914 \text{ mm}) < 48" (1219 \text{ mm})$

Tolerance: $\pm 3/8" \pm 10 \text{ mm}$

For lengths $\geq 48" (1219 \text{ mm}) < 72" (1830 \text{ mm})$

Tolerance: $\pm 1/2" \pm 13 \text{ mm}$

For lengths $\geq 72" (1830 \text{ mm})$

Tolerance: $\pm 1\%$

Elbow angle and angle of orientation

Tolerance: ± 3

Angle Couplings

A - To measure angle of offset of a hose assembly, point one end of coupling "A" (the nearest) to a vertical position downward. The angle can then be measured from the centreline of this vertical coupling in an anticlockwise direction to the centreline of coupling "B" (the far coupling) (see illustration).

Relationships can then be expressed from 0° to 360°. If angle not given elbows are positioned at 0°.

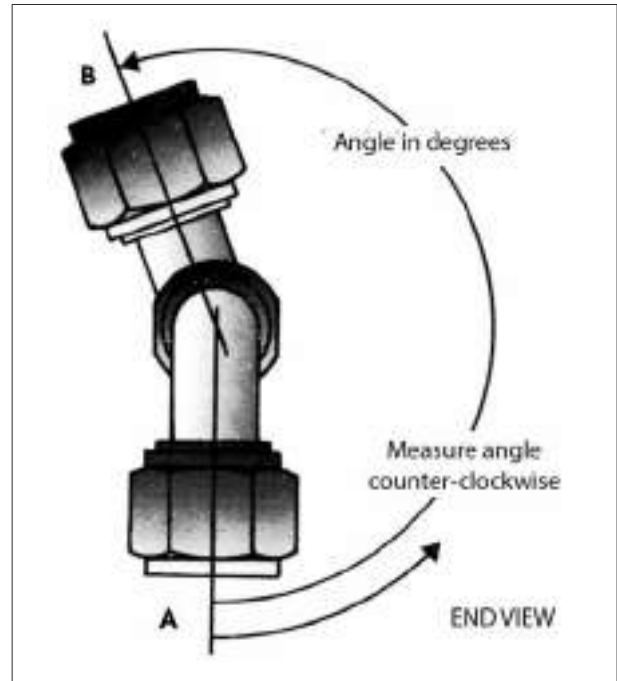

// FITTINGS GUIDELINES

FITTING IDENTIFICATION

Dash numbers

Most fluid piping system sizes are measured by dash numbers. These are universally used abbreviations for the size of component expressed as the numerator of the fraction with the denominator always being 16. For example, a -04 port is 4/16 or 1/4 inch. Dash numbers are usually nominal (in name only) and are abbreviations that make ordering of components easier.

There are many coupling systems used for hydraulic connections. They are identified as: **American, British, French, German, Japanese.**

This section lists the origin and coupling style. Descriptions and dimensional data follows each coupling style.

AMERICAN THREAD TYPES

NPTF (National Pipe Tapered Fuel)

This is a dryseal thread, the National pipe tapered thread for fuels. This is used for both male and female ends. This connection is still widely used in fluid power systems, even through it is not recommended by the National Fluid Power Association (N.F.P.A.) for use in hydraulic applications.

The NPTF male will mate with the NPTF, NPSF or NPSM female. The NPTF male has tapered threads and a 30° inverted seat. The NPTF female has tapered threads and no seat.

The seal takes place by deformation of the threads. The NPSM female has straight threads and a 30° inverted seat. The seal takes place on the 30° seat.

The NPTF connector is similar to, but not interchangeable with, the BSPT connector. The thread pitch is different in most sizes. Also, the thread angle is 60° instead of the 55° angle found on BSPT threads.

NPSF (National Pipe Straight Thread for Fuels)

The National pipe straight thread for fuels. This is sometimes used for female ends and properly mates with the NPTF male end. However, the SAE recommends the NPTF thread in preference to the NPSF for female ends.

NPSM (National Pipe Straight Mechanical)

National pipe straight thread for mechanical joint. This is used on the female swivel nut of iron pipe swivel adapters. The leak-resistant joint is not made by the sealing fit of threads, but by a tapered seat in the coupling end. This connection is sometimes used in fluid power systems.

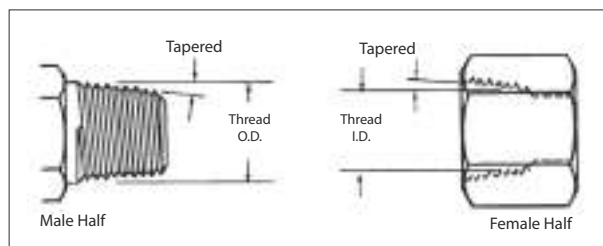

Thread Identification Table

National Pipe Straight Mechanical (NPSM)

National Pipe Tapered for Fuels (NPTF)

Dash	Tube Size	Thread Size	Female Thread I.D.		Male Thread O.D.	
	(in)	(in-TPI)	(mm)	(in)	(mm)	(in)
-2	1/8	1/8-27	8.7	0.34	10.3	0.41
-4	1/4	1/4-18	11.9	0.47	14.3	0.56
-6	3/8	3/8-18	15.1	0.59	17.5	0.69
-8	1/2	1/2-14	18.3	0.72	21.4	0.84
-12	3/4	3/4-14	23.8	0.94	27.0	1.06
-16	1	1-11.1/2	30.2	1.19	33.3	1.31
-20	1.1/4	11/4-11.1/2	38.9	1.53	42.9	1.69
-24	1.1/2	11/2-11.1/2	44.5	1.75	48.4	1.91
-32	2	2 - 11.1/2	57.2	2.25	60.3	2.38

SAE J514 Straight Thread O-Ring Boss (ORB)

This port connection is recommended by the N.F.P.A. for optional leakage control in medium and high pressure hydraulic systems. The O’ring boss male will mate with an O’ring boss female only.

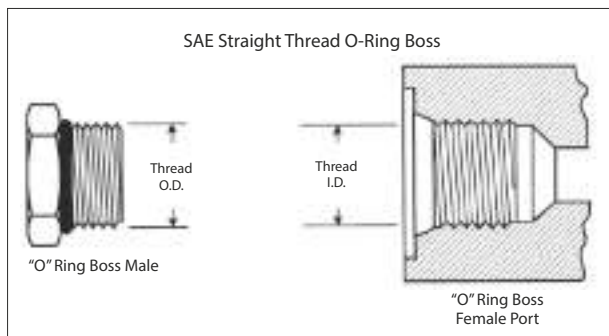

Thread Identification Table SAE J514 Straight Thread O-Ring Boss

Dash	Tube Size	Thread Size	Female Thread I.D.		Male Thread O.D.	
	(in)	(in-TPI)	(mm)	(in)	(mm)	(in)
-2	1/8	5/16-24	6.9	0.27	7.8	0.31
-3	3/16	3/8-24	8.5	0.34	9.4	0.37
-4	1/4	7/16-20	9.9	0.39	11.2	0.44
-5	5/16	1/2-20	11.5	0.45	12.6	0.49
-6	3/8	9/16-18	12.9	0.51	14.1	0.56
-8	1/2	3/4-16	17.5	0.69	18.9	0.74
-10	5/8	7/8-14	20.5	0.81	22.1	0.87
-12	3/4	1.1/16-12	24.9	0.98	26.9	1.06
-14	7/8	1.3/16-12	28.1	1.11	30.3	1.18
-16	1	1.5/16-12	31.3	1.23	33.1	1.31
-20	1.1/4	1.5/8-12	39.2	1.54	41.1	1.62
-24	1.1/2	1.7/8-12	45.6	1.79	47.4	1.87
-32	2	2.1/2-12	61.4	2.42	63.3	2.49

The male has straight threads and an O’ring. The female has straight threads and a sealing face. The seal is made at the O’ring on the male and the sealing face on the female. The threads hold the connection mechanically.

SAE J514 37° (JIC)

The Society of Automotive Engineers (SAE) specifies a 37° angle flare or seat be used with high pressure hydraulic tubing. These are commonly called JIC couplings. The JIC 37° flare male will mate with a JIC female only. The JIC male has straight threads and a 37° flare seat. The JIC female has straight threads and a 37° flare seat. The seal is made on the 37° flare seat by establishing a line contact between the male flare and the female cone seat. The threads hold the connection mechanically.

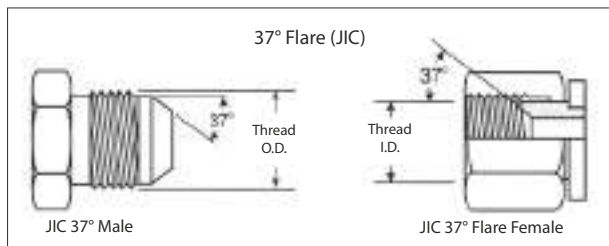

Thread Identification Table SAE J514 37° Flare (JIC)

Dash	Tube Size	Thread Size	Female Thread I.D.		Male Thread O.D.	
	(in)	(in-TPI)	(mm)	(in)	(mm)	(in)
-2	1/8	5/16-24	6.9	0.27	7.8	0.31
-3	3/16	3/8-24	8.5	0.34	9.4	0.37
-4	1/4	7/16-20	9.9	0.39	11.2	0.44
-5	5/16	1/2-20	11.5	0.45	12.6	0.49
-6	3/8	9/16-18	12.9	0.51	14.1	0.56
-8	1/2	3/4-16	17.5	0.69	18.9	0.74
-10	5/8	7/8-14	20.5	0.81	22.1	0.87
-12	3/4	1.1/16-12	24.9	0.98	26.9	1.06
-14	7/8	1.3/16-12	28.1	1.11	30.3	1.18
-16	1	1.5/16-12	31.3	1.23	33.1	1.31
-20	1.1/4	1.5/8-12	39.2	1.54	41.1	1.62
-24	1.1/2	1.7/8-12	45.6	1.79	47.4	1.87
-32	2	2.1/2-12	61.4	2.42	63.3	2.49

CAUTION: In the -02, -03, -04, -05, -08 and -10 sizes, the threads of the SAE 45° flare and the SAE 37° flare are the same. However, the sealing surface angles are not the same. Carefully measure the seat angle to differentiate.

SAE J512 45°

A term usually applied to fittings having a 45° angle flare or seat. Soft copper tubing is generally used in such applications as it is easily flared to the 45° angle. These are for low pressure applications - commonly used in refrigeration, automotive and truck piping systems. The SAE 45° flare male will mate with an SAE 45° flare female only.

The SAE male has straight threads and a 45° flare seat.

The SAE female has straight threads and a 45° flare seat.

The seal is made on the 45° flare seat.

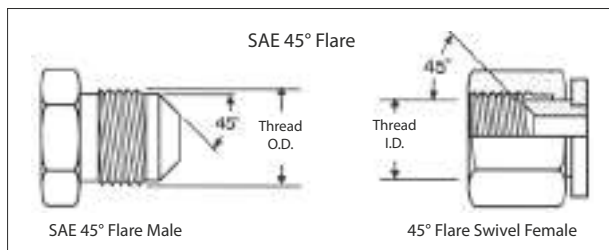

Thread Identification Table

SAE J512 45°

Dash	Tube Size	Thread Size	Female Thread I.D.		Male Thread O.D.	
	(in)	(in-TPI)	(mm)	(in)	(mm)	(in)
-2	1/8	5/16-24	6.9	0.27	7.9	0.31
-3	3/16	3/8-24	8.6	0.34	9.6	0.38
-4	1/4	7/16-20	9.9	0.39	11.2	0.44
-5	5/16	1/2-20	11.4	0.45	12.7	0.50
-6	3/8	5/8-18	14.2	0.56	15.7	0.62
-7	7/16	11/16-16	15.7	0.62	17.3	0.68
-8	1/2	3/4-16	17.0	0.68	19.0	0.75
-10	5/8	7/8-14	20.3	0.80	22.3	0.88
-12	3/4	1.1/16-14	25.1	0.99	26.9	1.06
-14	7/8	1.1/4-12	29.5	1.16	31.7	1.25
-16	1	1.3/8-12	32.5	1.28	35.0	1.38

The threads hold the connection mechanically. CAUTION: In the -02, -03, -04, -05, -08 and -10 sizes, the threads of the SAE 45° flare and the SAE 37° flare are the same. However, the sealing surface angles are not the same. Carefully measure the seat angle to differentiate.

SAE J1453 O-Ring Face Seal (ORFS)

A seal is made when the O-ring in the male contacts the flat face on the female. Couplings are intended for hydraulic systems where elastomeric seals are acceptable to overcome leakage and leak resistance is crucial. This connection offers the very best leakage control available today.

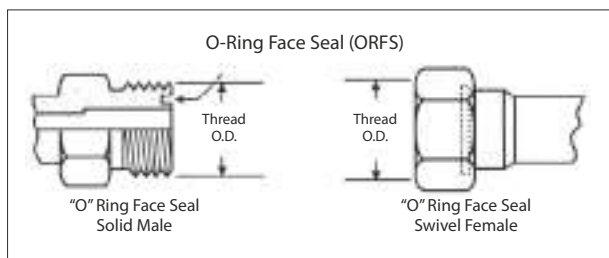

Thread Identification Table

SAE J1453 O-Ring Face Seal (ORFS)

Dash	Tube Size	Thread Size	Female Thread I.D.		Male Thread O.D.	
	(in)	(in-TPI)	(mm)	(in)	(mm)	(in)
-4	1/4	9/16-18	12.9	0.51	14.1	0.56
-6	3/8	11/16-16	15.9	0.63	17.3	0.68
-8	1/2	13/16-16	19.1	0.75	20.5	0.81
-10	5/8	1-14	23.6	0.93	25.2	0.99
-12	3/4	1.3/16-12	28.1	1.11	30.0	1.18
-16	1	1.7/16-12	34.4	1.36	36.3	1.43
-20	1.1/4	1.11/16-12	40.8	1.61	42.7	1.68
-24	1.1/2	2-12	48.7	1.92	50.6	1.99

The male connector has a straight thread and a machined flat face. The female has a straight thread and a machined flat face. The seal takes place by compressing the O-Ring onto the flat face of the female, similar to the split flange type fitting. The threads hold the connection mechanically.

SAE J512 Inverted Flare

This connection is frequently used in automotive systems. The male connector can either be a 45° flare in the tube fitting form or a 42° seat in the machined adapter form. The female has a straight thread with a 42° inverted flare. The seal takes place on the flared surface. The threads hold the connection mechanically

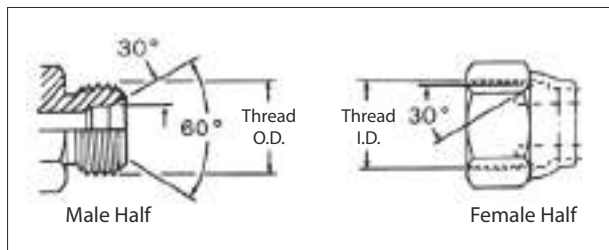

Thread Identification Table SAE J512 Inverted Flare

Dash	Tube Size	Thread Size	Female Thread I.D.		Male Thread O.D.	
	(in)	(in-TPI)	(mm)	(in)	(mm)	(in)
-2	1/8	5/16-28	6.9	0.27	7.9	0.31
-3	3/16	3/8-24	8.6	0.34	9.6	0.38
-4	1/4	7/16-24	9.9	0.39	11.2	0.44
-5	5/16	1/2-20	11.4	0.45	12.7	0.50
-6	3/8	5/8-18	14.2	0.56	15.7	0.62
-7	7/16	11/16-18	15.7	0.62	17.3	0.68
-8	1/2	3/4-18	17.0	0.68	19.0	0.75
-10	5/8	7/8-18	20.3	0.80	22.3	0.88
-12	3/4	1.1/16-16	25.1	0.99	26.9	1.06

SAE J1467 Clip Fastener

This is a radial O-Ring seal connection commonly used for hydraulic applications in underground mines. The male contains an exterior O-Ring and backup ring, plus a groove to accept the "staple". The female has a smooth bore with two holes for the staple.

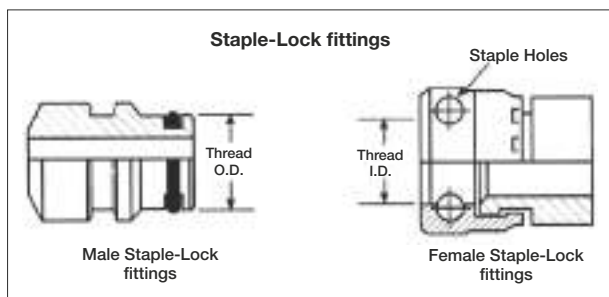

Thread Identification Table SAE J1467 Clip Fastener

Dash Size	Inch Size	Female Staple-Lock I.D.		Male Staple-Lock O.D.	
	(in)	(mm)	(in)	(mm)	(in)
-4	1/4	14.9	19/32	15.1	19/32
-6	3/8	19.9	51/64	20.1	51/64
-8	1/2	23.9	61/64	24.1	61/64
-12	3/4	28.9	1.9/64	29.1	1.9/64
-16	1	38.9	1.35/64	39.1	1.35/64
-20	1.1/4	45.9	1.13/16	46.1	1.13/16
-24	1.1/2	54.9	1.11/64	55.2	2.11/64
-32	2	63.9	1.17/32	64.2	2.17/32

A "U" shaped retaining clip or staple is inserted through the two holes, passing through the groove in the male to lock the connection together. The seal takes place by contact between the O-Ring in the male and the smooth bore of the female.

SAE J518/ISO - DIS 6162/JIS B8363 O-Ring Flange

This connection is commonly used in fluid power system. There are two pressure ratings. Code 61 Form R, PN 35/350 bar, Type I, is referred to as the “standard” series and Code 62 Form S, PN 415 bar, Type II, is the “heavy duty” “6000 psi” series. The design concept for both series is the same, but the bolt hole spacing and flanged head diameters are larger for the higher pressure, Code 62 connection.

The female (port) is an unthreaded hole with four bolt holes in a rectangular pattern around the port.

The male consists of a flanged head, grooved for an O-Ring, and either a captive flange or split flange halves with bolt holes to match the port. The seal take place on the O-Ring, which is compressed between the flange head and the flat surface surrounding the port. The threaded bolts hold the connection together.

SAE J518, DIN 20066, ISO/DIS 6162 and JIS B 8363 are interchangeable, except for bolt sizes.

*All Code 61 flange head hose couplings meet or exceed SAE J518 Code 61 requirements for hydraulic split flange connections. The Code 61 flange head design can withstand a maximum operating pressure of 3000 to 5000 psi depending on size.

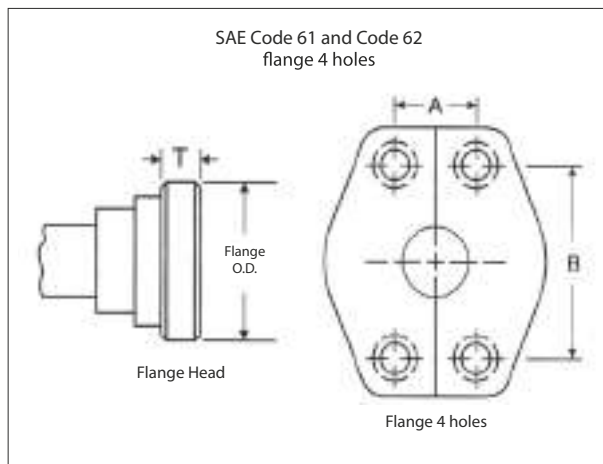

Flange Dash	SAE Cod 61 FORM R - PN 35/350 - TYPE I								SAE Cod 62 FORM S - PN 415 - TYPE II								CATERPILLAR								
	Flange Head Size		Flange Head T		A		B		Flange Head Size		Flange Head T		A		B		Flange Head Size		Flange Head T		A		B		
Size	(in)	(mm)	(in)	(mm)	(in)	(mm)	(in)	(mm)	(in)	(mm)	(in)	(mm)	(in)	(mm)	(in)	(mm)	(in)	(mm)	(in)	(mm)	(in)	(mm)	(in)	(mm)	
-8	1.19	30.2	.265	6.7	.69	17.5	1.50	38.1	1.25	31.8	.305		.71	18.2	1.59	40.5									
-10*	1.34	34.0	.265	6.7	.78	19.8	1.69	42.9																	
-12	1.50	38.1	.265	6.7	.87	22.2	1.89	47.6	1.63	41.3	.345	8.7	.94	23.8	2.00	50.8	1.63	41.3	.56	14.2	.94	23.8	2.00	50.8	
-16	1.75	44.5	.315	8.0	1.03	26.2	2.05	52.4	1.88	47.6	.375	9.5	1.10	27.8	2.25	57.2	1.88	47.6	.56	14.2	1.10	27.8	2.25	57.2	
-20	2.00	50.8	.315	8.0	1.19	30.2	2.31	58.7	2.13	54.0	.405	10.3	1.26	31.8	2.63	66.7	2.13	54.0	.56	14.2	1.26	31.8	2.63	66.7	
-24	2.38	60.3	.315	8.0	1.41	35.7	2.75	69.9	2.50	63.5	.495	12.6	1.44	36.6	3.13	79.4	2.50	63.5	.56	14.2	1.44	36.6	3.13	79.4	
-32	2.81	71.4	.375	9.5	1.69	42.9	3.06	77.8	3.13	79.4	.495	12.6	1.73	44.4	3.81	96.8	3.13	79.4	.56	14.2	1.73	44.4	3.81	96.8	
-40	3.31	84.1	.375	9.5	2.00	50.8	3.50	88.9																	

T = Thickness

-10 is a non SAE size flange

How to measure

Four Bolt Flange - First measure the port hole diameter using the caliper.

Next, measure the longest bolt hole spacing from centre-to-centre (Dimension “A”) or measure the flanged head diameter. O.D.

1. The size -10, which is common outside of North America is not an SAE Standard size.
2. Caterpillar flanges, which are the same flange O.D. as SAE Code 62, have a thicker flange head.
3. Poclain flanges, which are completely different from SAE flanges.

BRITISH CONNECTIONS

British Standard Pipe Parallel (BSPP)

This connection is frequently used in automotive systems. The male connector can either be a 45° flare in the tube fitting form or a 42° seat in the machined adapter form. The female has a straight thread with a 42° inverted flare. The seal takes place on the flared surface. The threads hold the connection mechanically.

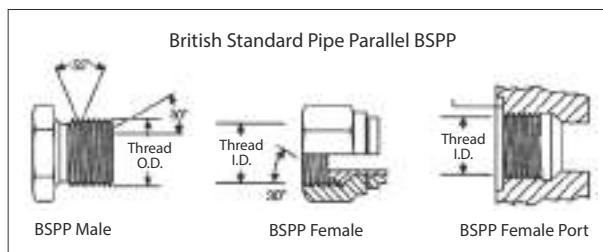

British Standard Pipe Tapered (BSPT)

The BSPT (tapered) male will mate with a BSPT (tapered) female, or a BSPP (parallel) female. The BSPT male has tapered threads. When mating with either the BSPT (tapered) female or the BSPP (parallel) female port, the seal is made on the threads accomplished by thread distortion. A thread sealant is recommended.

The BSPT connector is similar to, but not interchangeable with, the NPTF connector. The thread pitch is different in most cases, and the thread angle is 55° instead of the 60° angle found on NPTF threads.

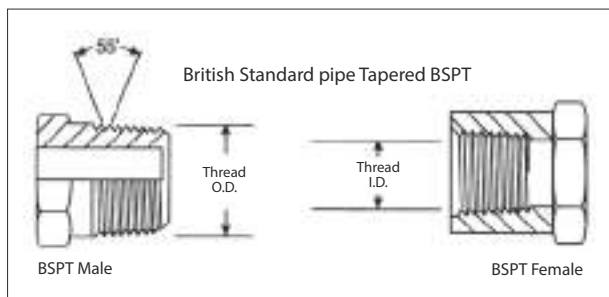

Thread Identification Table

BSPP - (British Standard Pipe Parallel)

BSPT - (British Standard Pipe Tapered)

Dash Size	Inch Size	Thread Size	Female Thread I.D.		Male Thread O.D.	
			(mm)	(in)	(mm)	(in)
-2	1/8	1/8-28	8.7	0.34	9.5	0.38
-4	1/4	1/4-19	11.1	0.44	13.5	0.56
-6	3/8	3/8-19	15.1	0.59	16.7	0.66
-8	1/2	1/2-14	18.3	0.72	20.6	0.81
-10	5/8	5/8-14	20.6	0.81	23.0	0.91
-12	3/4	3/4-14	23.8	0.94	26.2	1.03
-16	1	1-11	30.2	1.19	33.3	1.31
-20	1-1/4	1-1/4-11	38.9	1.53	41.1	1.66
-24	1-1/2	1-1/2-11	45.2	1.78	47.6	1.88
-32	2	2-11	56.4	2.22	59.5	2.34

FRENCH CONNECTIONS

French GAZ have a 24° seat and metric threads. These are similar to German DIN couplings, but the threads are different in some sizes, the French use fine threads in all sizes. French flanges are different than SAE, they have a lip that protrudes from the flange face. These are Poclairn style flanges.

Millimetrique and GAZ 24°

This connection consists of a common male and two different females. The French Metric (GAZ) male will mate with the female 24° cone or the female tube fitting. The male has a 24° seat and straight metric threads. The female has a 24° seat or a tubing sleeve and straight metric threads. The Millimetrique Series is used with whole number metric O.D. tubing and the GAZ Series is used with fractional number metric O.D. pipe size tubing.

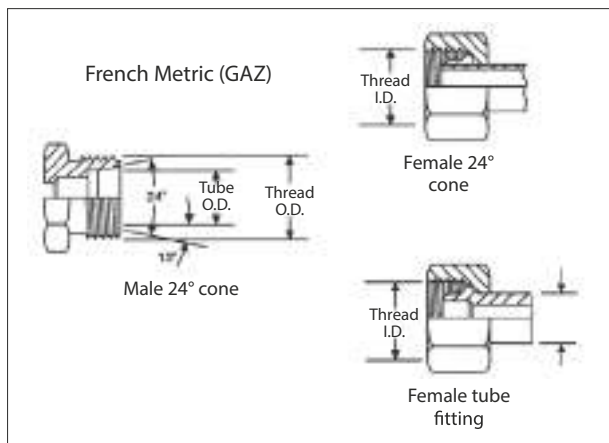

Thread Identification Table French Metric Millimetrique

Metric Thread (dia x pitch)	Female Thread I.D.		Male Thread O.D.		Tube O.D.	
	(mm)	(in)	(mm)	(in)	(mm)	(in)
M12 X 1.0	11.0	0.43	12.0	0.47	6	0.24
M14 X 1.5	12.5	0.49	14.0	0.55	8	0.31
M16 X 1.5	14.5	0.57	16.0	0.63	10	0.39
M18 X 1.5	16.5	0.65	18.0	0.71	12	0.47
M20 X 1.5	18.5	0.73	20.0	0.79	14	0.55
M22 X 1.5	20.5	0.81	22.0	0.87	15	0.59
M24 X 1.5	22.5	0.89	24.0	0.94	16	0.63
M27 X 1.5	25.5	1.00	27.0	1.06	18	0.71
M30 X 1.5	28.5	1.12	30.0	1.18	22	0.87
M33 X 1.5	31.5	1.24	33.0	1.30	25	0.98
M36 X 1.5	34.5	1.36	36.0	1.42	28	1.10
M39 X 1.5	37.5	1.48	39.0	1.54	30	1.18
M42 X 1.5	40.5	1.59	42.0	1.65	32	1.26
M45 X 1.5	43.5	1.71	45.0	1.77	35	1.38
M48 X 1.5	46.5	1.83	48.0	1.89	38	1.50
M52 X 1.5	50.5	1.99	52.0	2.05	40	1.57
M54 X 2.0	51.9	2.04	54.0	2.13	45	1.77

Thread Identification Table French Metric GAZ 24° Cone

Dash Size (dash)	Metric Thread (dia x pitch)	Female Thread I.D.		Male Thread O.D.		Tube O.D.	
		(mm)	(in)	(mm)	(in)	(mm)	(in)
-6	M20 X 1.5	18.5	0.73	20.0	0.78	13.25	0.52
-8	M24 X 1.5	22.5	0.89	24.0	0.94	16.75	0.66
-10	M30 X 1.5	28.5	1.12	30.0	1.18	21.25	0.83
-12	M36 X 1.5	34.5	1.36	36.0	1.41	26.75	1.05
-16	M45 X 1.5	43.5	1.71	45.0	1.77	33.50	1.32
-20	M52 X 1.5	50.5	1.99	52.0	2.04	42.25	1.66

GAZ Poclairn 24° Flange

The Poclairn (French GAZ) 24° high pressure flange is usually found on Poclairn equipment. The male flange will mate with a female flange or a port. The seal is made on the 24° seat.

Nominal Size (in)	A		B		E	
	(mm)	(in)	(mm)	(in)	(mm)	(in)
1/2	39.9	1.57	18.3	.72	14	.55
5/8	39.9	1.57	18.3	.72	14	.55
3/4	50.8	2	23.9	.94	18	.71

GERMAN DIN CONNECTIONS

A coupling referred to as metric, usually means a DIN coupling. Flanges are standard Code 61 or Code 62.

DIN 2353 24° Cone

The DIN 24° cone male will mate with any of the three females shown below.

The male has a 24° seat, straight metric threads, and a recessed counterbore which matches the tube O.D. used with it. The mating female may be a 24° cone with O’ring, (DKO type) a metric tube fitting or a universal 24° or 60° cone.

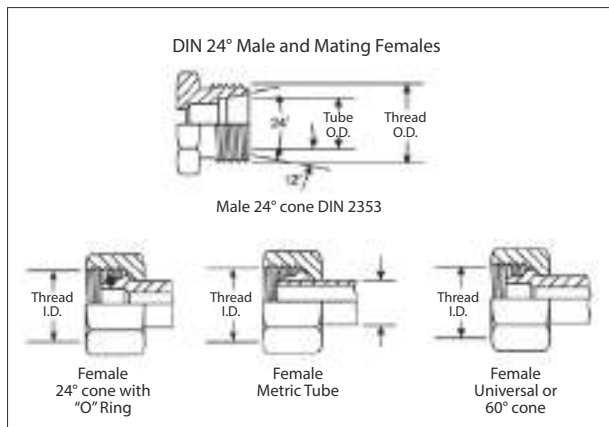

Thread Identification Table DIN 24° Cone

Metric Thread (dia x pitch)	Female Thread I.D.		Male Thread O.D.		Tube O.D.			
	(mm)	(in)	(mm)	(in)	Light Series		Heavy Series	
					(mm)	(in)	(mm)	(in)
M12 X 1.5	10.5	0.41	12	0.47	6	0.24		
M14 X 1.5	12.5	0.49	14	0.55	8	0.31	6	0.24
M16 X 1.5	14.5	0.57	16	0.63	10	0.39	8	0.31
M18 X 1.5	16.5	0.65	18	0.71	12	0.47	10	0.39
M20 X 1.5	18.5	0.73	20	0.79			12	0.47
M22 X 1.5	20.5	0.81	22	0.87	15	0.59	14	0.55
M24 X 1.5	22.5	0.89	24	0.94			16	0.63
M26 X 1.5	24.5	0.96	26	1.02	18	0.71		
M30 X 2.0	27.9	1.10	30	1.18	22	0.87	20	0.79
M36 X 2.0	33.9	1.33	36	1.42	28	1.10	25	0.98
M42 X 2.0	39.9	1.57	42	1.65			30	1.18
M45 X 2.0	42.9	1.69	45	1.77	35	1.38		
M52 X 2.0	49.9	1.96	52	2.05	42	1.65	38	1.50

There is a light and heavy series DIN coupling. Proper identification is made by measuring both the thread size and the tube O.D. (The heavy series has a smaller tube O.D. than the light, but has a thicker wall section).

DIN 3863 60° Cone

This connection is frequently used in hydraulic systems. The DIN 60° cone male will mate with the female universal 24° or 60° cone only.

The male has a 60° seat and straight metric threads. The female has a 24° and 60° universal seat and straight metric threads. The seal takes place by contact between the cone of the male and the nose of the flareless swivel. The threads hold the connection mechanically.

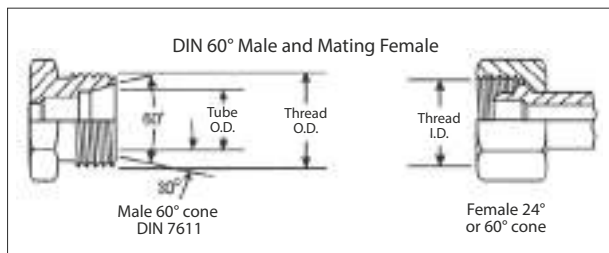

Thread Identification Table DIN 60°

Metric Thread (dia x pitch)	Female Thread I.D.		Male Thread O.D.		Tube O.D.	
	(mm)	(in)	(mm)	(in)	(mm)	(in)
M12 X 1.5	10.5	0.41	12	0.47	6	0.24
M14 X 1.5	12.5	0.49	14	0.55	8	0.31
M16 X 1.5	14.5	0.57	16	0.63	10	0.39
M18 X 1.5	16.5	0.65	18	0.71	12	0.47
M22 X 1.5	20.5	0.81	22	0.87	15	0.59
M26 X 1.5	24.5	0.96	26	1.02	18	0.71
M30 X 1.5	28.5	1.12	30	1.18	22	0.87
M38 X 1.5	36.5	1.44	38	1.50	28	1.10
M45 X 1.5	43.5	1.71	45	1.77	35	1.38
M52 X 1.5	50.5	1.99	52	2.05	42	1.65

Metric Standpipe

A metric standpipe is comprised of three components attached to a male fitting. The components are a Standpipe, Bite Sleeve and Metric Nut. The nut is placed over the Standpipe, followed by the Bite Sleeve (see illustration below). For DIN light assemblies, a DIN light metric nut is used. For DIN heavy assemblies, a DIN heavy metric nut is used. Bite Sleeve and Standpipe are selected on the basis of tube O.D.

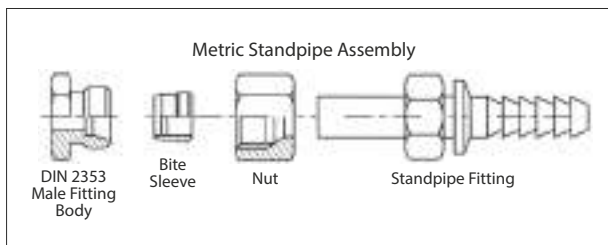

Tube O.D. (mm)	Metric Nut Thread	
	Light	Heavy
6	M12 x 1.5	
8	M14 x 1.5	M16 x 1.5
10	M16 x 1.5	M18 x 1.5
12	M18 x 1.5	M20 x 1.5
15	M22 x 1.5	
16		M24 x 1.5
18	M26 x 1.5	
20		M30 x 2.0
22	M30 x 1.5	
25		M36 x 2.0
28	M36 x 2.0	
30		M42 x 2.0
35	M45 x 2.0	
38		M52 x 2.0
42	M52 x 2.0	

JAPANESE CONNECTIONS

Japanese equipment uses JIS (Japanese Industrial Standard) couplings with a 30° seat and British Standard Pipe Parallel threads. All flanges are Code 61 or Code 62 (except -10).

JIS 30° Flare Parallel Pipe Threads - JIS B 0202

These Japanese 30° flare male coupling will mate with a Japanese 30° flare female only. The male and female have straight threads and a 30° seat. The seal is made on the 30° seat. The threads on the Japanese 30° flare connector conform to JIS B 0202, the same as the BSPP threads. Both the British and Japanese connectors have a 30° seat, but they are not interchangeable, because the British seat is inverted.

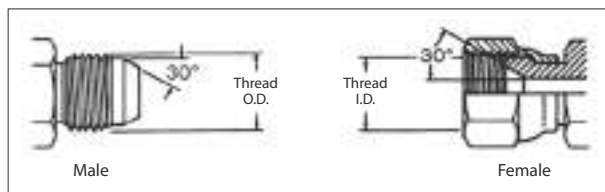

JIS 30° Inverted Seat, Parallel Pipe Threads - JIS B 0202

The JIS parallel is similar to the BSPP connection. The JIS parallel thread and the BSPP connection are interchangeable.

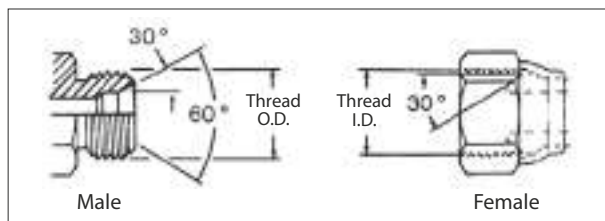

JIS Tapered Pipe Thread (PT) - JIS B 0203

The JIS tapered pipe thread connection is similar to the BSPT connection and fully interchangeable. The Japanese connection does not have a 30° Flare, and will not mate with the BSPP female. The thread conforms to JIS B 0203, same as BSPT threads. The seal on the JIS tapered pipe thread connection is made on the threads.

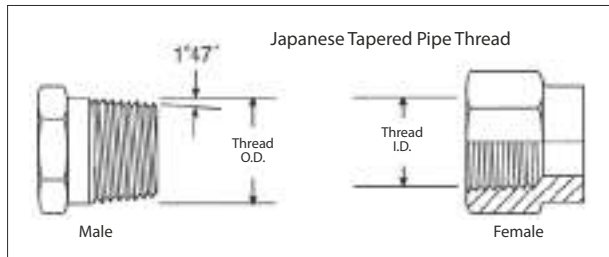

Thread Identification Table

Dash Size	Inch Size	Thread Size (in-TPI)	Female Thread I.D.		Male Thread O.D.	
			(mm)	(in)	(mm)	(in)
-2	1/8	1/8-27	8.7	0.34	9.5	0.38
-4	1/4	1/4-18	11.1	0.44	13.5	0.56
-6	3/8	3/8-18	15.1	0.59	16.7	0.66
-8	1/2	1/2-14	18.3	0.72	20.6	0.81
-10	5/8	5/8-14	20.6	0.81	23.0	0.91
-12	3/4	3/4-14	23.8	0.94	26.2	1.03
-16	1	1-11	30.2	1.19	33.3	1.31
-20	1-1/4	1.1/4-11	38.9	1.53	41.1	1.66
-24	1-1/2	1.1/2-11	45.2	1.78	47.6	1.88
-32	2	2-11	56.4	2.22	59.5	2.34

Komatsu Style 30° Flare Parallel Threads

The Komatsu style 30° Flare Parallel thread coupling is identical to the Japanese 30° Flare parallel except for the threads. The Komatsu uses Metric fine threads which conform to JIS B 0207. The Komatsu connector seals on the 30° Flare.

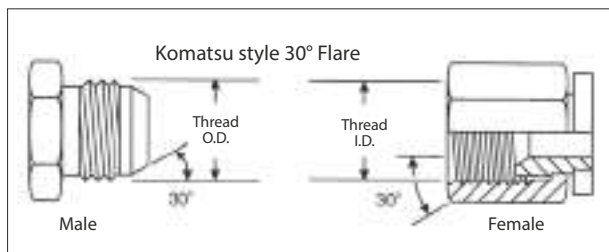

Dash Size	Inch Size	Metric Thread Size	Male Thread O.D. (mm)	B Thread I.D. (mm)
-6	3/8	M18x1.5	18	16.4
-8	1/2	M22x1.5	22	20.4
-10	5/8	M24x1.5	24	22.4
-12	3/4	M30x1.5	30	28.4
-16	1	M33x1.5	33	31.4
-20	1-1/4	M36x1.5	36	34.4
-24	1-1/2	M42x1.5	42	40.4

Komatsu Flange Fitting

The Komatsu Flange fitting is nearly identical to and fully interchangeable with the SAE Code 61 flange fitting. In all sizes the O-ring dimensions are different. When replacing a Komatsu flange with an SAE style flange, an SAE style O-ring must be used.

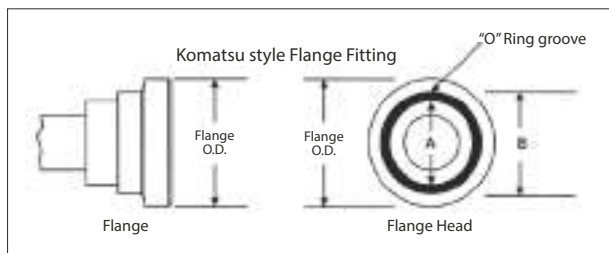

Flange Dash Size	Flange Size (In)	A	B
-8	1.19	.73	.98
-10*	1.34	.73	1.10
-12	1.50	.85	1.22
-16	1.75	1.12	1.50
-20	2.00	1.36	1.73
-24	2.38	1.75	2.12
-32	2.81	2.22	2.56

*is a non SAE size flange

RECOMMENDED FITTING AND ADAPTER INSTALLATION TORQUE

SAE J514 37° CONE (JIC)

Dash	Thread	Lb.ft		N.m	
		Min	Max	Min	Max
-4	7/16-20	11	12	15	16
-5	1/2-20	14	15	19	21
-6	9/16-18	18	20	24	28
-8	3/4-16	36	39	49	53
-10	7/8-14	57	63	77	85
-12	1 1/16-12	79	88	107	119
-14	1 3/16-12	94	103	127	140
-16	1 5/8-12	108	113	147	154
-20	1 5/8-12	127	133	172	181
-24	1 7/8-12	158	167	215	226
-32	2 1/2-12	245	258	332	350

BSPP without O-Ring

Dash	Thread	Lb.ft	N.m
-2	1/8-28	7	10
-4	1/4-19	15	20
-6	3/8-19	26	35
-8	1/2-14	44	60
-10	5/8-14	52	70
-12	3/4-14	85	115
-16	1-11	103	140
-20	1 1/4-11	155	210
-24	1 1/2-11	214	290
-32	2-11	295	400

SAE J1453 O-Ring Face Seal (ORFS)

Dash	Thread	Lb.ft		N.m	
		Min	Max	Min	Max
-4	9/16-18	18	21	25	28
-6	11/16-16	30	32	40	44
-8	13/16-16	41	44	55	60
-10	1-14	46	50	60	68
-12	1 3/16-12	65	70	90	95
-16	1 7/16-12	92	100	125	135
-20	1 11/16-12	125	140	170	190
-24	2-12	150	165	200	225

BSPP with O-Ring

Dash	Thread	Lb.ft	N.m
-2	1/8-28	N/A	N/A
-4	1/4-19	15	20
-6	3/8-19	26	35
-8	1/2-14	37	50
-10	5/8-14	44	60
-12	3/4-14	63	85
-16	1-11	85	115
-20	1 1/4-11	140	190
-24	1 1/2-11	177	240
-32	2-11	221	300

SAE Flange J518 Code 61

Dash	Thread	Lb.ft		N.m	
		Min	Max	Min	Max
-8	1/2	15	19	20	25
-12	3/4	21	29	28	40
-16	1	27	35	37	48
-20	1 1/4	35	46	48	62
-24	1 1/2	46	58	62	79
-32	2	54	66	73	90
-40	2 1/2	79	91	107	124
-48	3	137	149	186	203

JIS (B8363)

Dash	Thread	Lb.ft	N.m
-4	1/4-19	19	25
-6	3/8-19	25	34
-8	1/2-14	49	64
-10	5/8-14	100	132
-12	3/4-14	100	132
-16	1-11	149	196
-20	1 1/4-11	171	225
-24	1 1/2-11	194	255
-32	2-11	240	316

SAE J518 Code 62

Dash	Thread	Lb.ft		N.m	
		Min	Max	Min	Max
-8	1/2	15	19	20	25
-12	3/4	25	33	34	45
-16	1	42	50	56	68
-20	1 1/4	63	75	85	102
-24	1 1/2	117	133	158	181
-32**	2	200	217	271	294

Metric

Thread	Lb.ft		N.m	
	Min	Max	Min	Max
M12x1,5	8	11	15	20
M14x1,5	13	18	25	30
M16x1,5	19	26	35	40
M18x1,5	22	30	40	45
M20x1,5	24	33	45	50
M22x1,5	32	44	60	70
M24x1,5	41	55	75	85
M26x1,5	46	63	85	95
M30x2	57	77	105	120
M36x2	74	100	135	150
M42x2	111	151	205	230
M45x2	136	184	250	280
M52x2	147	199	270	300

JIC FFFT TORQUE METHOD

The FFFT (Flats From Finger Tight) method allows to assemble fittings and adapters at the correct torque value without a dynamometric wrench. The rotation applied according the value shown in tab.1 ensures a good sealing, avoid unscrewing and over torque that can cause nut or cone crack.

Assembling instruction:

- hand tighten the joint
- make a longitudinal mark on one of the flats of hex and continue it on the body hex as shown in Fig.1
- tighten the joint further by the number of flat as shown in Tab.1/2 according to JIC version.

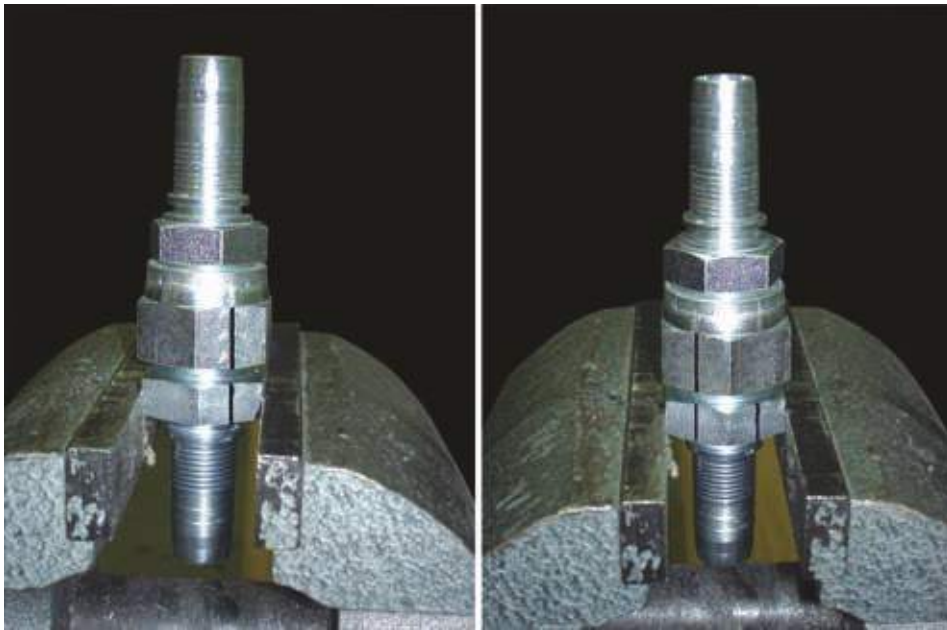

Fig. 1

CRIMPED NUT JIC VERSION						
Assembling value - carbon steel material - SAE J514 JIC 37° flare						
Dash size	Thread	Lb*ft		N*m		FFFT 0/+0.25
		min	max	min	max	
-4	7/16-20	11	12	15	16	2
-5	1/2-20	14	15	19	21	2
-6	9/16-18	18	20	24	28	2
-8	3/4-16	36	39	49	53	1.5
-10	7/8-14	57	63	77	85	1.5
-12	1 1/16-12	79	88	107	119	1
-14	1 3/16-12	94	103	127	140	1
-16	1 5/16-12	108	113	147	154	1
-20	1 5/8-12	127	133	172	181	1
-24	1 7/8-12	158	167	215	226	1
-32	2 1/2-12	245	258	332	350	1

Tab. 1

SLIP-ON NUT JIC VERSION						
Assembling value - carbon steel material - SAE J514 JIC 37° flare						
Dash size	Thread	Lb*ft		N*m		FFFT 0/+0.25
		min	max	min	max	
-4	7/16-20	11	12	15	16	1
-5	1/2-20	14	15	19	21	1
-6	9/16-18	18	20	24	28	1
-8	3/4-16	36	39	49	53	1
-10	7/8-14	57	63	77	85	1
-12	1 1/16-12	79	88	107	119	0,75
-16	1 5/16-12	108	113	147	154	0,75

Tab. 2

HOW TO DETERMINE THE THREAD TYPE USING CALLIPERS

By measuring with a caliper the outside diameter of the thread of a male or the inside diameter of the thread of a female you will get a measure in mm. By finding this value in mm on the below table, you'll be able to find the relevant thread type.

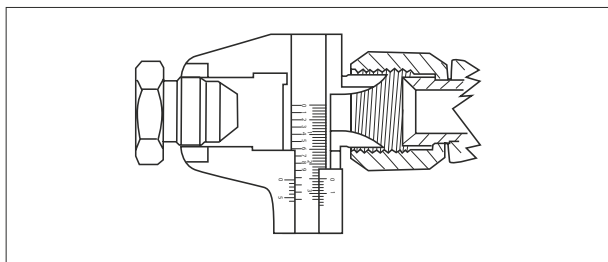

Male OD	mm	Female ID
	8,7	G1/8" BSP
1/8" – 27 NPTF	9,5	
G1/8" BSP	9,6	
M 10 x 1	9,8	
	9,9	7/16" – 20 JIC
	10,5	M 12 x 1,5
7/16" – 20 JIC	11,0	
	11,4	1/2" – 20 SAE
	11,6	G1/4" BSP
M 12 x 1,5	11,9	
1/4" – 18 NPTF	12,5	
	12,5	M 14 x 1,5
1/2" – 20 SAE	12,6	
	12,9	9/16" – 18 JIC
G1/4" BSP	13,0	
M 14 x 1,5	13,9	
9/16" – 18 JIC	14,2	
	14,5	M16 x 1,5
	15,1	G3/8" BSP
M 16 x 1,5	15,8	
3/8" – 18 NPTF	15,9	
	16,5	M18 x 1,5
G3/8" BSP	16,6	
	17,5	3/4" – 16 JIC
M 18 x 1,5	17,9	
	18,4	20 x 1,5 DKF
3/4" – 16 JIC	18,8	
	18,8	G1/2" BSP
1/2" – 14 NPT	19,8	
20 x 1,5 CEF	19,9	
	20,4	7/8" – 14 SAE
	20,5	M 22 x 1,5
G1/2" BSP	20,8	
	20,9	G5/8" BSP
M 22 x 1,5	21,9	
7/8" – 14 SAE	22,1	
	22,5	24 x 1,5 DKF
G5/8" BSP	22,8	
24 x 1,5 CEF	23,9	
	24,5	G3/4" BSP
	24,8	1 1/16" – 12 JIC
3/4" – 14 NPTF	25,1	
	25,5	M26 x 1,5
M 26 x 1,5	25,9	
G3/4" BSP	26,3	
1 1/16" – 12 JIC	26,8	

Male OD	mm	Female ID
	27,9	1 3/16" – 12 JIC
	28,0	M 30 x 2
	28,5	30 x 1,5 DKF
M 30 x2	29,8	
30 x 1,5 CEF	29,9	
1 3/16" – 12 JIC	30,1	
	30,7	G1" BSP
	31,2	1 5/16" – 12 JIC
1" – 11 1/2 NPTF	31,4	
	31,5	M 33 x 1,5
G1" BSP	33,1	
1 5/16" – 12 JIC	33,2	
	34,0	M 36 x 2
	34,5	36 x 1,5 DKF
M 36 x 2	35,8	
36 x 1,5 CEF	35,9	
	36,5	M 36 x 1,5
M 38 x 1,5	37,9	
	38,8	1 5/8" – 12 JIC
	39,4	G1 1/4" BSP
	39,8	M 42 x 1,5
1 1/4"–11 1/2 NPTF	40,2	
	40,5	M 42 x 1,5
1 5/8" – 12 JIC	41,1	
1 1/4" – 11 BSP	41,7	
M 42 x2	41,8	
	42,4	M 45 x 2
	43,3	45 x 1,5 DKF
M 45 x2	44,8	
45 x 1,5 CEF	44,9	
	45,1	1 7/8" – 12 JIC
	45,2	G1 1/2" BSP
1 1/2"–11 1/2 NPTF	46,3	
1 7/8" – 12 JIC	47,5	
G1 1/2" BSP	47,7	
	49,6	M 52 x 2
	50,3	52 x 1,5 DKF
M 52 x2	51,8	
52 x 1,5 CEF	51,9	
	57,4	G2" BSP
2" – 11 1/2 NPTF	58,3	
G2" BSP	59,4	
	61,1	2 1/2" – 12 JIC
	62,5	M 65 x 2
2 1/2" – 12 JIC	63,3	

PRESSURE CONVERSION TABLES

Metric to psi (1 KPa = .145 psi)

Kilo Pascal (KPa)	Mega Pascal (KPa)	Bar (Bar)	Pounds per Square Inch (psi)
100	0,1	1	14,5
200	0,2	2	29,0
300	0,3	3	43,5
400	0,4	4	58,0
500	0,5	5	72,5
600	0,6	6	87,0
700	0,7	7	101,5
800	0,8	8	116,0
900	0,9	9	130,5
1000	1	10	145,0
2000	2	20	290,1
3000	3	30	435,1
4000	4	40	580,2
5000	5	50	725,5
6000	6	60	870,2
7000	7	70	1015
8000	8	80	1160
9000	9	90	1305
10000	10	100	1450
20000	20	200	2901
30000	30	300	4351
40000	40	400	5802
50000	50	500	7252
60000	60	600	8702
70000	70	700	10153
80000	80	800	11603
90000	90	900	13053
100000	100	1000	14504
200000	200	2000	29008
300000	300	3000	43511

psi to metric (1 psi = 6,89 KPa)

Pounds per Square Inch (psi)	Kilo Pascal (KPa)	Mega Pascal (MPa)	Bar (Bar)
10	68,9	0,07	0,7
20	137,9	0,14	1,4
30	206,8	0,21	2,1
40	275,8	0,28	2,8
50	344,7	0,34	3,4
60	413,7	0,41	4,1
70	482,6	0,48	4,8
80	551,6	0,55	5,5
90	620,5	0,62	6,2
100	689	0,70	6,9
200	1379	1,4	13,8
300	2068	2,1	20,7
400	2758	2,8	27,6
500	3447	3,4	34,5
600	4137	4,1	41,4
700	4826	4,8	48,3
800	5516	5,5	55,2
900	6205	6,2	62,1
1000	6895	6,9	68,9
2000	13790	13,8	147,9
3000	20684	20,7	206,8
4000	27579	27,6	275,8
5000	34474	34,5	344,7
6000	41369	41,4	413,7
7000	48263	48,3	482,6
8000	55158	55,2	551,6
9000	62053	62,1	620,5
10000	68948	68,9	689
20000	137895	147,9	1379
30000	206843	206,8	2068
40000	275790	275,8	2758

CONVERSION TABLES FROM IMPERIAL SYSTEM TO METRIC SYSTEM

Inches	mm
1/64	.0156
1/32	.0312
3/64	.0468
1/16	.0625
5/64	.0781
3/32	.0937
7/64	.1093
1/8	.1250
9/64	.1406
5/32	.1562
11/64	.1718
3/16	.1875
13/64	.2031
7/32	.2187
15/64	.2343
1/4	.2500

Inches	mm
17/64	.2656
9/32	.2812
19/64	.2968
15/16	.3125
21/64	.3281
11/32	.3437
23/64	.3593
3/8	.3750
25/64	.3906
13/32	.4062
27/64	.4218
7/16	.4375
29/64	.4531
15/32	.4687
31/64	.4843
1/2	.5000

Inches	mm
33/64	.5156
17/32	.5312
35/64	.5468
9/16	.5625
37/64	.5781
19/32	.5937
39/64	.6093
5/8	.6250
41/64	.6406
21/32	.6562
43/64	.6718
11/16	.6875
45/64	.7031
23/32	.7187
47/64	.7343
3/4	.7500

Inches	mm
49/64	.7656
25/32	.7812
51/64	.7968
13/16	.8125
53/64	.8281
27/32	.8437
55/64	.8593
7/8	.8750
57/64	.8906
29/32	.9062
59/64	.9218
15/16	.9375
61/64	.9531
31/32	.9687
63/64	.9843
1	1000

// ADAPTERS GUIDELINES

ADAPTER SELECTION

Selection of an appropriate Alfacomma adapter for a given application depends on the fluid system operating parameters listed below and the tube material and wall thickness they require:

1. Type of fluid
2. Operating temperature range
3. Type of line - pressure, return or suction
4. Maximum flow rate through the line
5. Maximum operating / service pressure
6. Severity of service
7. Environment

Then, based on the tube selected and appropriate fluid system operating parameters, determine adapter type(s) and material(s) using the features comparison table below.

FEATURES COMPARISON OF TUBE FITTINGS				
Feature		ORFS	JIC 37°	BSP
Performance	Pressure capability*	Very High	Medium to High	Medium to High
	Seal Reliability	Excellent	Good	Very Good
		Elastomeric Seal	Metal to Metal Seal	Elastomeric Seal
		High tolerance to minor surface imperfections and damage. High tolerance to assembly variations.	Low tolerance to minor surface imperfections and damage. Low tolerance to assembly variations.	Low tolerance to minor surface imperfections and damage. Low tolerance to assembly variations.
Vibration Resistance in Rigid Systems	Excellent	Good	Very Good	
Tube Compatibility	Wall Thickness	All	Medium	Medium
	Critical Features	OD tolerance and hardness for flat tube, OD tolerance only for brazed tube	ID finish, wall thickness uniformity (concentricity) and hardness	OD tolerance and hardness
Assembly	Tube Preparation	Easy and quick (slower for sleeve brazing)	Easy and quick	Easy and quick (slower for welded nipple)
	Inspection	Easy and quick	Easy and quick	Critical, need experience
	Ease of Installation	Excellent, Minimum skill and training are necessary because of high tolerances to assembly variations	Good. Low tolerance to assembly variations. Requires skilled and trained personnel	
	Ease of Maintenance	Excellent, no tube entry	Very Good, Small tube entry	Good, Large tube entry
Temperature Capability Adapters without O-Ring	Steel	To be used only with O-ring	-65° F to 500° F	-65° F to 500° F
	Stainless Steel		-425° F to 1200° F	==
	Brass		-40° F to 400° F	==
Temperature Capability Adapters with O-Ring**	All Style of Adapter	-30 F to 250° F	-30 F to 250° F	-30 F to 250° F

* For details see Working Pressure Charts in the individual adapters section

** For details concerning O-ring see section "O-ring selection" and "Fluid Resistance Table"

JIC 37° ADAPTER (ISO 8434-2, SAE J514)

Main Features

SAE J514 and ISO 8434-2, and commonly called 37° JIC adapters.

37° JIC adapter performs extremely well in all high pressure applications.

The seal is made by connecting a 37° flared tube surface to a 37° flare male and tightening by means of a nut and a sleeve. The flared tube avoids welded connection, so high performances are guaranteed even in case of severe vibrations, mechanic/hydraulic shocks and multiple assembly/disassembly operations.

When tightened, sleeve provides tube and adapter self alignment and helps to reduce the vibrations on the tube during application.

An appropriate choice of sleeve gives the possibility of assembling adapters with both metric and inch-tubes.

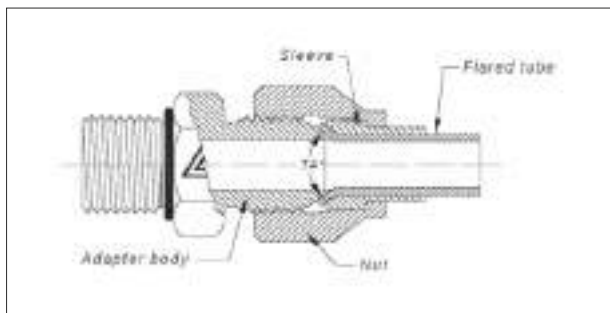

Flaring Operations

Perfect sealing is guaranteed with tubes having physical and mechanical characteristics obtained by cold-drawing and a ductility expressed as 21% of minimum elongation.

- Cut end of tube must be perpendicular to its axis . Note: cutting operation reduces the whole length of tube (almost 0,5±1mm for each end).
- Dimensions of the end of the tube shall allow the correct placing on the flaring machine.
- Flared surface must be inspected to avoid excessive roughness and defects such as cracks or exfoliation.
- Length of flared zone shall be enough to allow a sufficient sealing surface and avoid the blowing off of the tube, but not excessive to prevent the contact with thread of the nut.
- A well followed flaring procedure assures no leakage even after frequent assembling and disassembling operations.

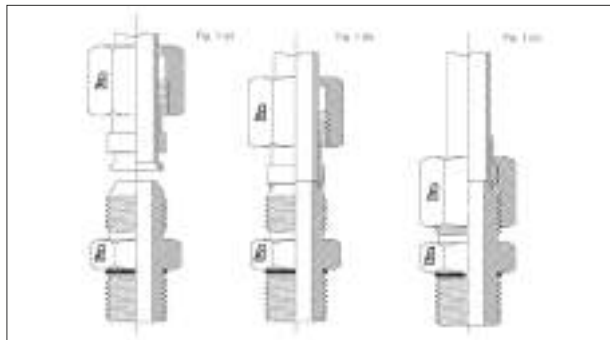

ORFS ADAPTER (ISO 8434-3, SAE J1453)

Main Features

Adapters are designed and manufactured according to standard SAE J1453 and commonly called ORFS adapters.

O-Ring Face Seal adapters performs extremely well in all high pressure applications where elastomeric seals are needed to overcome leakage and leak resistance is crucial.

A seal is made when the O-Ring in the male contacts the 180° flat face of the tube. The male connector has a straight thread and a machined flat face. The seal takes place by compressing the O-Ring onto the flat face of the female.

ORFS system is composed by:

- Nut.
- Sleeve for flat tube and a shouldered sleeve for brazing. An appropriate choice of sleeve gives the possibility of assembling adapters with both metric and inch-tubes.
- Various kind and size of adapter body.
- O-Ring material is NBR, Shore "A": 90, suitable for a temperature range of: - 30°/+130° C (-22/+266° F).

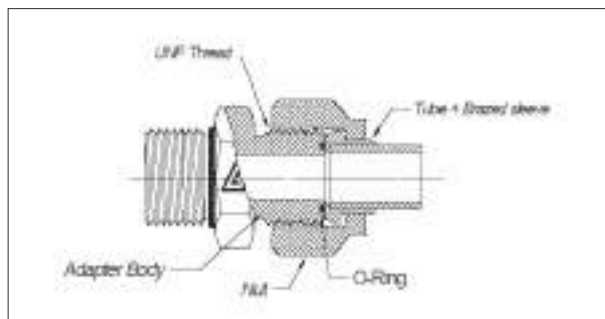

Flaring Tube Operations

Perfect sealing is guaranteed with tubes having physical and mechanical characteristics obtained by cold-drawing and a ductility expressed as 21% of minimum elongation.

- Cut end of tube must be perpendicular to its axis.
- Cutting operation reduces the whole length of tube.
- Dimensions of the end of the tube shall allow the correct placing on the flaring machine.
- Flared surface must be inspected to avoid excessive roughness and defects such as cracks or exfoliation.
- Brazing sleeve guarantees the same performances as the flared tube, and shall be used in the following cases:
 - Tube is not in accordance with the above mechanical characteristics.
 - The straight part of the tube is not of a sufficient length (see quote L2 and values listed in table of figure O-3).
 - Tube thickness is lower than values listed in table (O-1).
 - For cutting length consider shoulder of the sleeve (quote L1 of table O-1).

A well followed flaring procedure assures no leakage even after frequent assembling and disassembling operations.

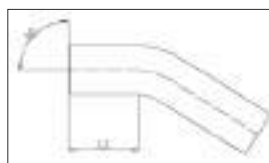

Hose mm	L2 Min mm
Ø 6 - Ø 12	73
Ø 14 - Ø 18	100
Ø 20 - Ø 22	120
Ø 25 - Ø 42	130

Only a few simple operations are required for assembling ORFS tube/adaptor.

Sleeve and Tube Flared:

- 1a) Place nut and sleeve on the tube with the appropriate orientation.
- 2a) Flare the tube (see procedure)
- 3a) Place the tube near seal surface of the adapter and screw by hand.
- 4a) Lock the adapter and tighten with a torque wrench

Brazed sleeve

- 1b) Cut the tube considering quote L1 of the sleeve (See Figure O-5);
- 2b) Clean and degrease accurately the end of the tube and the sleeve;
- 3b) Put the brazing ring into the sleeve
- 4b) Apply flux at the end of the tube and in the sleeve, then assemble the sleeve on the tube;
- 5b) Start brazing and be aware of not overheating flux material;
- 6b) Clean the connecting part and verify the good quality of weld around the external diameter of the hose;
- 7b) Complete the assembly procedure as described in points 3a) and 4a). See the correct installation torque in the attached table (O-2).

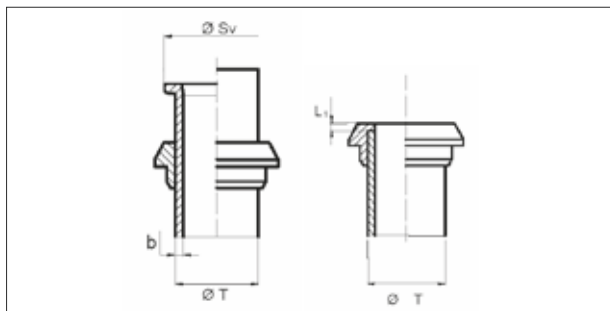

Hose		SV	
mm	In	mm	In
6	1/4	12,0	12,7
8	5/16	14,7	15,7
10	3/8	14,7	15,7
12	1/2	17,9	18,9
15		22,1	23,4
16	5/8	22,1	23,4
18		26,3	27,8
20	3/4	26,3	27,8
22		32,4	34,2
25	1	32,4	34,2
28		39,0	40,5
30		39,0	40,5
32	1.1/4	39,0	40,5
35		46,0	48,5
38	1.1/2	46,0	48,5

BSP ADAPTER (ISO 8434-6, BS 5200)

Main Features

Adapters are designed and manufactured according to standard BS 5200, ISO 8434-6 and ISO 228-1 and they are commonly called BSP adapters (British Standard Pipe) BSP adapter is widely employed, it performs extremely well in all high pressure applications with oil and gas. The seal is made by connecting a 60° coned seat to the 60° male surface and tightening the nut assembly. The O-Ring placed in the tube groove improves the sealing. There are not welded part in the locking area and performances are good even after multiple assembly and disassembly operations, severe vibrations and mechanic/hydraulic shocks.

Assembling Procedure

Only a few simple operations are required for assembling BSP tube/adaptor:

1. Carefully align tube and adapter. Otherwise sealing is not guaranteed.
2. Lubricate accurately sealing surfaces with mineral oil or suitable lubricant.
3. Place the tube near seal surface of the adapter and tight by hand.
4. Lock the adapter and tighten with a torque wrench. See the correct installation torque in the attached table B-1.

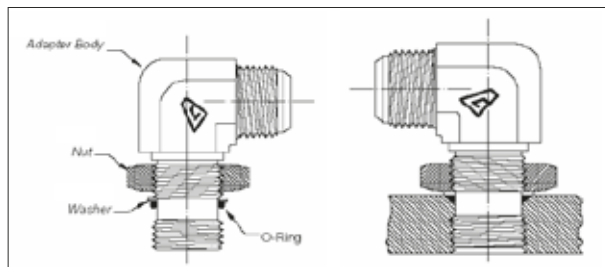

Assembly Instruction For Adjustable Adapter Thread: SAE, UNF, BSPP, Metric

Lubricate the O-Ring with mineral oil. Back off locknut as for as possible.

Make sure that washer is pushed-up as much as possible. Screw by hand the adapter into the port until the ORing enter the port.

To align adaptor orientation to tube end or hose assembly, unscrew the adaptor by the required amount, but not more than one full turn.

Hold the adapter in desired position by mean of a wrench and tighten locknut to the suggested torque value by means of a dynamometric wrench.

METRIC PORT - ISO 6149 - SAE 2244-1

Metric Thread	D2 ²⁾ min	D3 ³⁾ min	D5 +0,10	D6 +0,50	L1 +0,40	L2 min	L3 max	L4	Z° ±1°	Assembly Torque +10%
D1	mm	mm	mm	mm	mm	mm	mm	mm		Nm
M8x1	17	14	9,1	14	1,6	11,5	1	10	12°	10
M10x1	20	16	11,1	16	1,6	11,5	1	10	12°	20
M12x1,5	23	19	13,8	19	2,4	14	1,5	11,5	15°	35
M14x1,5(1)	25	21	15,8	21	2,4	14	1,5	11,5	15°	45
M16x1,5	28	24	17,8	24	2,4	15,5	1,5	13	15°	55
M18x1,5	30	28	19,8	26	2,4	17	2	14,5	15°	70
M22x1,5	34	29	23,8	29	2,4	18	2	15,5	15°	100
M27x3	40	34	29,4	34	3,1	22	2	19	15°	170
M33x2	49	43	35,4	43	3,1	22	2,5	19	15°	310
M42x2	60	52	44,4	52	3,1	22,5	2,5	19,5	15°	330
M48x2	66	57	50,4	57	3,1	25	2,5	22	15°	420
M60x2	76	67	52,4	67	3,1	27,5	2,5	24,5	15°	500

- 1) Preferred for diagnostic port application
- 2) Spotface diameter with identification ridge
- 3) Spotface diameter without identification ridge

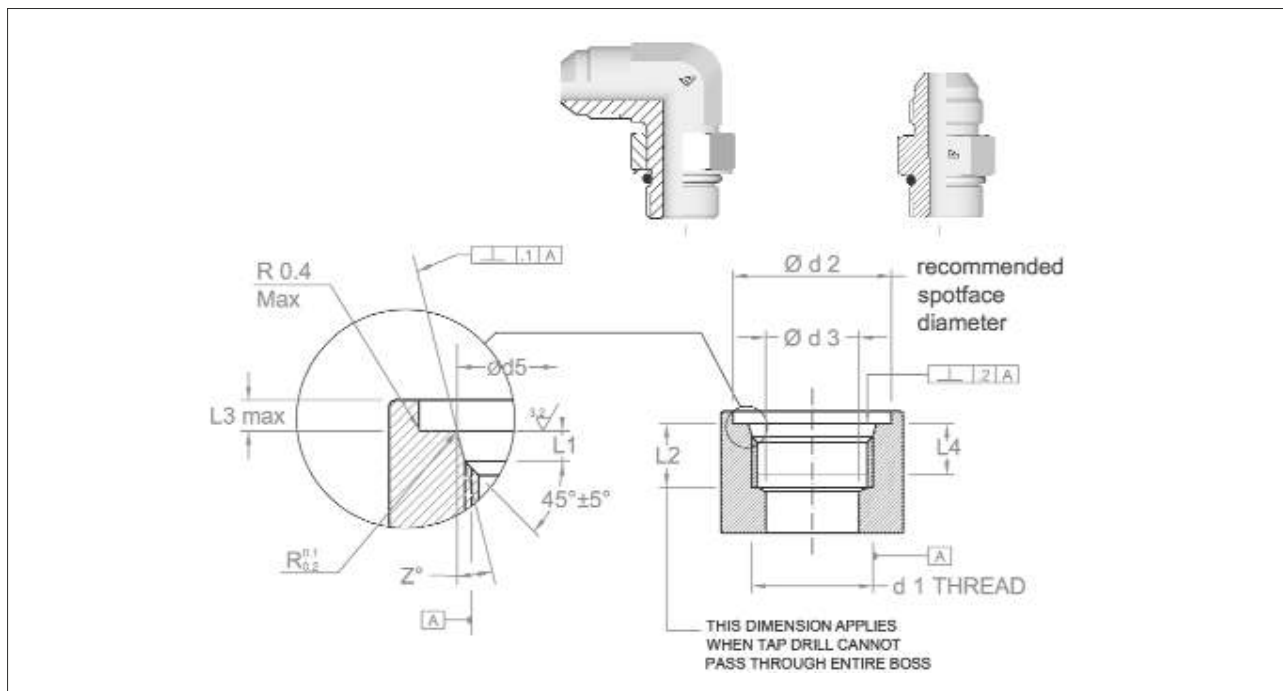

SAE UNF PORT - SAE J1926-1 - ISO 11926

ANSI B1.1	D2	D3 min	D3 +0,13	L1 +0,40	L2 min	L3 max	L4 min	Z° ±1°	Assembly Torque +10%
D1	mm	mm	mm	mm	mm	mm	mm		Nm
7/16"-20	21	4,4	12,4	2,4	14	1,6	11,5	12°	20
1/2"-20	23	6	14	2,4	14	1,6	11,5	12°	25
9/16"-18	25	7,5	15,6	2,5	15,5	1,6	12,7	12°	35
3/4"-16	30	10	20,6	2,5	17,5	2,4	14,3	15°	70
7/8"-14	34	12,5	23,9	3,3	20	2,4	16,7	15°	100
1" 1/16-12	41	16	29,2	3,3	23	2,4	19	15°	170

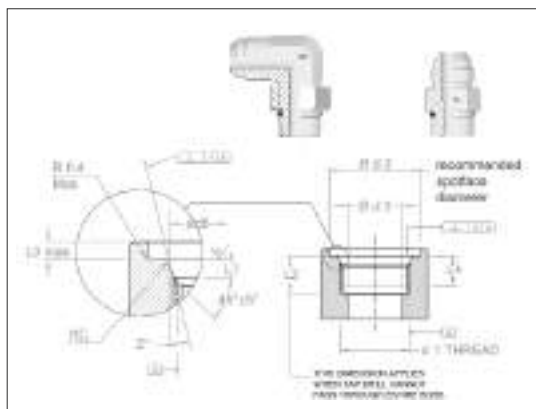

BSPP PORT - ISO 9974 - DIN 3852-1

ANSI B1.1 Thread	D3 +0.20	D4	L1 max	L2 min	Assembly Torque +10%
D1	mm	mm	mm	mm	Nm
1/8"-28	9,8	15	1	8	20
1/4"-19	13,2	20	1,5	12	50
3/8"-19	16,7	23	2	12	80
1/2"-14	21	28	2,5	14	100
3/4"-14	26,5	33	2,5	16	200
1"-11	33,3	41	2,5	18	380
1" 1/4-11	42	51	2,5	20	500
1" 1/2-11	47,9	56	2,5	22	600

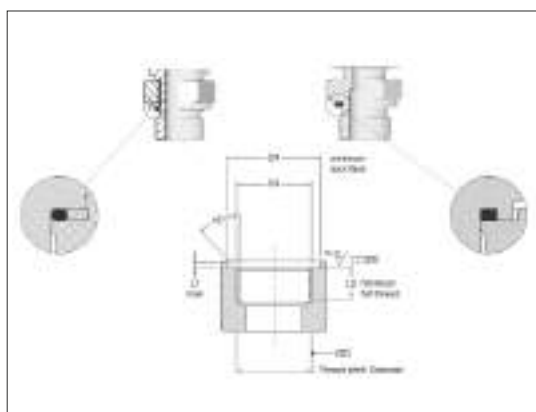

METRIC PORT - ISO 9974 - DIN 3852-1

Metric Thread	D3 +0.20	D4 min	L1 max	L2 min	Assembly Torque +10%
D1	mm	mm	mm	mm	Nm
M12x1,5	12	18	1,5	12	35
M14x1,5	14	20	1,5	12	45
M16x1,5	16	23	1,5	12	55
M18x1,5	18	25	2	12	68
M20x1,5	20	27	2	14	80
M22x1,5	22	28	2,5	14	98
M27x2	27	33	2,5	16	180
M33x2	33	41	2,5	18	310
M42x2	42	51	2,5	20	330
M48x2	48	56	2,5	22	400

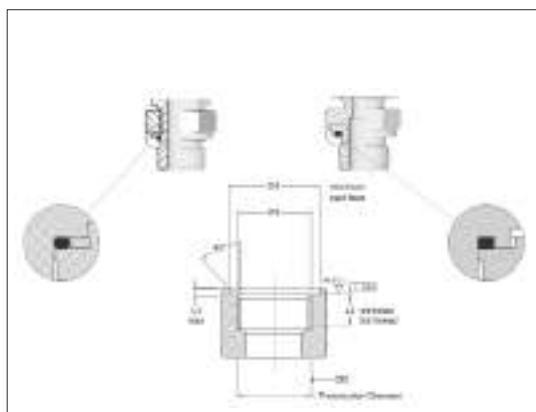

// HOSE

// THERMOPLASTIC

MINIMESS - Pressure test point.....	7
FLEXOR 7 - SAE 100 R7 - EN 855 R7.....	7
FLEXOR 7 - TWIN - SAE 100 R7 - EN 855 R7.....	8
FLEXOR 8 - SAE 100 R8 - EN 855 R8.....	8
FLEXOR TWB1 - One wire braid.....	8
FLEXOR TWB1 - TWIN - One wire braid - Twin.....	9
FLEXOR VHP700 RED.....	9

// TEXTILE BRAID

ARGUS 1TE/R6 - exceeds SAE J517 100 R6 - EN 854 1TE.....	10
ARGUS 2TE - EN 854 2TE.....	10
ARGUS 3TE/R3 - EN 854 3TE - exceeds SAE J517 100 R3.....	11
2TE RAILWAY - EN 854 2TE - EN 45545-2.....	11

// WIRE BRAID

FLEXOPAK PLT.....	12
FLEXOPAK 1SC - EN 857 1SC - ISO 11237.....	12
AT3K - MINETUFF - SAE 100 R17 - EN 857 1SC - ISO 11237.....	13
FLEXOR 1SN/R1AT - SAE 100 R1AT - ISO 1436-1 - UNI EN 853 1SN.....	13
FLEXOR 1SN/R1AT - MINETUFF - SAE 100 R1AT - ISO 1436-1 - UNI EN 853 1SN.....	14
FLEXOR 5 - SAE 100 R5 - J1402 DOT All FM VSS 106.....	14
FLEXOPAK 2SC - EN 857 2SC - ISO 11237.....	15
FLEXOPAK 2 - MINETUFF - EN 857 2SC (up to 1") - ISO 11237 - SAE 100 R16.....	15
FLEXOPAK 2 TWIN - MINETUFF - EN 857 2SC - ISO 11237 - SAE 100 R16.....	16
FLEXOR 2SN/R2AT - SAE 100 R2AT - ISO 1436-1 - UNI EN 853 2SN.....	16
FLEXOR 2SN/R2AT - MINETUFF - SAE 100 R2AT - ISO 1436-1 - UNI EN 853 2SN.....	17
FLEXOR ELEVATOR - EN 81.20.....	17
ALFAFOREST.....	18
2SC RAILWAY - EN 857 2SC - ISO 11237 - EN 45545-2.....	18

// WIRE SPIRAL - ALFABIOTECH EVOLUTION

ALFABIOTECH EVOLUTION 3000 - MINETUFF - ISO 18752 - exceeds SAE 100 R12.....	20
ALFABIOTECH EVOLUTION 4000 - MINETUFF - ISO 18752.....	20
ALFABIOTECH EVOLUTION 5000 - MINETUFF - exceeds ISO 18752.....	21
ALFABIOTECH EVOLUTION 5000 PLUS - MINETUFF - ISO 18752.....	21
ALFABIOTECH EVOLUTION 6000 - MINETUFF - ISO 18752 - exceeds SAE 100 R15.....	22

// WIRE SPIRAL - ALFABIOTECH

ALFABIOTECH 2000 - MINETUFF - ISO 18752.....	23
ALFABIOTECH 3000 - MINETUFF - ISO 18752 - exceeds SAE 100 R12.....	23
ALFABIOTECH 4000 - MINETUFF - ISO 18752.....	24
ALFABIOTECH 5000 - MINETUFF - ISO 18752.....	24
ALFABIOTECH 5000 PLUS - MINETUFF - ISO 18752.....	25
ALFABIOTECH 6000 - MINETUFF - ISO 18752 - exceeds SAE 100 R15.....	25

// SUPERTUFF

AT3K - SUPERTUFF - SAE 100 R17 - EN 857 1SC - ISO 11237.....	26
FLEXOPAK 2 - SUPERTUFF - EN 857 2SC - ISO 11237 - SAE 100 R16.....	26
ALFABIOTECH 5000 - SUPERTUFF - ISO 18752.....	27
ALFABIOTECH 6000 - SUPERTUFF - ISO 18752 - exceeds SAE 100 R15.....	27
ALFABIOTECH EVOLUTION 4000 - SUPERTUFF - ISO 18752.....	28
ALFABIOTECH EVOLUTION 5000 - SUPERTUFF.....	28
ALFABIOTECH EVOLUTION 5000 PLUS - SUPERTUFF.....	29
ALFABIOTECH EVOLUTION 6000 - SUPERTUFF - ISO 18752 - exceeds SAE 100 R15.....	29

// HIGH TEMPERATURE

R5 EVOLUTION HT 150 - SAE 100 R5.....	30
1SN EVOLUTION HT 150 - SAE 100 R1AT - ISO 1436-1 - UNI EN 853 1SN.....	30
2SN EVOLUTION HT 150 - SAE 100 R2AT - ISO 1436-1 - UNI EN 853 2SN.....	31

// LOW TEMPERATURE

FLEXOPAK 2 LT 32.....	
ALFAFOREST LT 32.....	
EVOLUTION 4000 LT - ISO 18752.....	33
EVOLUTION 5000 LT - exceeds ISO 18752.....	33
EVOLUTION 6000 LT - ISO 18752 - exceeds SAE 100 R15.....	34

// OIL RETURN LINES

FLEXOR R4 604 - SAE 100 R4.....	35
FLEXOR R4 634 Extra flexible - SAE 100 R4.....	35
FLEXOR R4 644 HT - Extra flexible - High temperature - SAE 100 R4.....	36

// PRESSURE WASH

ALFAJET 210.....	37
ALFAJET 400.....	37

// PTFE

9TS OM Smooth PTFE Stainless Steel braid - Standard duty.....	38
9TC OM Convoluted PTFE Stainless Steel braid.....	39

// STANDARD FITTINGS**// FERRULES**

H1200TX2 No-Skive Ferrule for 3TE, R5 and Flexopak 2 Minetuff 2 1/2" - 241T Hi-tuff hoses.....	48
H1200TX4 No-Skive Ferrule for R4 Hoses (604, 634, 644).....	48
H1200103 No-Skive Ferrule for PLT.....	49
H1200AD1 No-Skive Ferrule for 1 Wire Braid and 2 Wire Braid Compact Hoses.....	49
H1200AD2 No-Skive Ferrule for 2SN.....	50
H1200204 No-Skive Ferrule for Alfabiotech/Powerflexbio Hoses.....	50
H1200TP0 No-Skive Ferrule for Thermoplastic and 1 Wire Braid Compact Hoses.....	51
H2200TF0 No-Skive Ferrule for PTFE Hoses.....	51
H1100SK1 Skive Ferrule for 1 Wire Braid and 2 Wire Braid Compact Hoses - No-Skive for 1TE, 2TE and R6.....	52
H1100104 Skive Ferrule for 1SN.....	52
H1100404 Skive Ferrule for 2/3 Wire Braid and Wire Spiral Hoses.....	52

// HOSE MENDER

H12C5610 Hose Mender.....	53
---------------------------	----

// BSP INSERTS

H1210510 BSPP Male 60° Flare - AGR.....	54
H1210610 BSPP Male Flat Seat - AGR FD.....	54
H1210710 BSPT Male - AGR K.....	55
H1220813 BSPP Female 60° Cone with O-Ring - DKOR.....	56
H1220843 45° BSPP Female 60° Cone with O-Ring - DKOR 45 - Solid one piece.....	57
H1220893 90° BSPP Female 60° Cone with O-Ring - DKOR 90 - Solid one piece.....	58
H1220581 90° Compact BSPP Female 60° Cone - DKR 90.....	58
H1220613 BSPP Female Flat Seat - DKR FD.....	59
H1230310 BSPP Banjo - RNR.....	59
H10V0210 BSPP Bolt.....	60

// DIN METRIC INSERTS

H1211110 Metric Male 24° Seat - DIN 3853 - Light Series - CEL.....	61
H1221513 Metric Female 24° Cone with O-Ring - ISO 8434-1 - Light Series - DKOL.....	62
H1221543 45° Metric Female 24° Cone with O-Ring - ISO 8434-1 - Light Series - DKOL 45 - Solid one piece.....	63
H1221593 90° Metric Female 24° Cone with O-Ring - ISO 8434-1 - Light Series - DKOL 90 - Solid one piece.....	64
H1211210 Metric Male 24° Seat - DIN 3853 - Heavy Series - CES.....	65
H1221613 Metric Female 24° Cone with O-Ring - ISO 8434-1 - Heavy Series - DKOS.....	66
H1221643 45° Metric Female 24° Cone with O-Ring - ISO 8434-1 - Heavy Series - DKOS 45 - Solid one piece.....	67
H1221693 90° Metric Female 24° Cone with O-Ring - ISO 8434-1 - Heavy Series - DKOS 90 - Solid one piece.....	67
H1221313 Universal Metric Female.....	68
H1221343 45° Universal Metric Female.....	68
H1221393 90° Universal Metric Female.....	68
H1221013 Metric Female 60° Cone - DIN 3863.....	69
H1221093 90° Metric Female 60° Cone - DIN 3863 - Solid one piece.....	69
H1252010 Metric Straight Standpipe - DIN 2353 - RSL/RSS.....	70
H1252040 45° Metric Standpipe - DIN 2353 - RSL45/RSS 45 - Solid one piece.....	71
H1252090 90° Metric Standpipe - DIN 2353 - RSL 90/RSS90 - Solid one piece.....	71
H1230910 Metric Banjo - RNM.....	72
H10V0810 Metric Bolt.....	72

// PRESSURE WASHER

H1224914 Universal Female for Pressure Washer.....	73
--	----

// SAE INSERTS

H1226611 SAE Female Swivel 45° Seat.....	74
H1213010 SAE Male Solid - O-Ring Boss.....	74
H1213011 SAE Male Swivel - O-Ring Boss.....	75
H1213081 90° Compact SAE Male Swivel - O-Ring Boss.....	75

// JIC 37° INSERTS

H1212510	JIC Male 37° Cone - AGJ.....	76
H1222511	JIC Female 37° Seat - DKJ.....	77
H1226511	JIC Female 37° Seat with Stem Hexagon - DKJ.....	78
H1226514	JIC Female 37° Seat with double Hexagon - DKJ and solid nut.....	79
H1222541-M	45° JIC Female 37° Seat - Medium Drop - DKJ 45M - Solid one piece.....	79
H1226544-M	45° JIC Female 37° Seat - Medium Drop - DKJ 45M - Solid nut and double Hexagon crimped.....	80
H1222591-S	90° JIC Female 37° Seat - Short Drop - DKJ 90S - Solid one piece.....	80
H1226594-S	90° JIC Female 37° Seat - Short Drop - Solid Nut and double Hexagon crimped.....	81
H1222591-M	90° JIC Female 37° Seat - Medium Drop - DKJ 90M - Solid one piece.....	81
H1226594-M	90° JIC Female 37° Seat - Medium Drop - Solid Nut and double Hexagon crimped.....	82
H1222591-L	90° JIC Female 37° Seat - Long Drop - DKJ 90L - Solid one piece.....	82
H1226594-L	90° JIC Female 37° Seat - Long Drop - Solid Nut and double Hexagon crimped.....	83

// NPTF INSERTS

H1212810	NPTF Male 60° Seat - AGN.....	84
H1222810	NPTF Female Solid.....	84
H1212811	NPTF Male Swivel 60° Seat.....	85
H1212881	90° Compact NPTF Male Swivel 60° Seat.....	85

// NPSM INSERTS

H1227311	NPSM Female.....	86
----------	------------------	----

// ORFS INSERTS

H1212410	ORFS Male.....	87
H1222411	ORFS Female with Stem Hexagon.....	88
H1222414	ORFS Female with support Hexagon knurled.....	88
H1222443-S	45° ORFS Female - Short Drop - DK ORFS 45M - Solid one piece.....	89
H1222493-S	90° ORFS Female - Short Drop - DK ORFS 90S - Solid one piece.....	89
H1222493-M	90° ORFS Female - Medium Drop - DK ORFS 90M - Solid one piece.....	90
H1222493-L	90° ORFS Female - Long Drop - DK ORFS 90L - Solid one piece.....	90

// FRENCH INSERTS

H1211810	Metric Male - French Type.....	91
H1221813	Metric Female - French Type.....	91
H1221893	90° Metric Female - French Type.....	91

// JIS INSERTS

H1223711	JIS Female 60° Cone - B 8363 (Type C).....	92
H1223741	45° JIS Female 60° Cone - B 8363 (Type C).....	92
H1223791	90° JIS Female 60° Cone - B 8363 (Type C).....	92
H122381Z	JIS Female 60° Seat Flare - B 8363 (Type F).....	93
H122384Z	45° JIS Female 60° Seat Flare - B 8363 (Type F).....	93
H122389Z	90° JIS Female 60° Seat Flare - B 8363 (Type F).....	93

// KOMATSU INSERTS

H1224011	Komatsu Female.....	94
H1244110	Komatsu Flange.....	94
H1244140	45° Komatsu Flange - Solid one piece.....	94
H1244190	90° Komatsu Flange - Solid one piece.....	95

// SAE FLANGES

H1243310	Flange SAE 3000 psi J518 Code 61 - SFL.....	96
H1243320	22° Flange SAE 3000 psi J518 Code 61 - SFL 22 - Solid one piece.....	96
H1243330	30° Flange SAE 3000 psi J518 Code 61 - SFL 30 - Solid one piece.....	97
H1243340	45° Flange SAE 3000 psi J518 Code 61 - SFL 45 - Solid one piece.....	97
H1243360	60° Flange SAE 3000 psi J518 Code 61 - SFL 60 - Solid one piece.....	98
H1243390	90° Flange SAE 3000 psi J518 Code 61 - SFL 90 - Solid one piece.....	98
H1243610	Flange SAE 6000 psi J518 Code 62 - SFS.....	99
H1243640	45° Flange SAE 6000 psi J518 Code 62 - SFS 45 - Solid one piece.....	99
H1243690	90° Flange SAE 6000 psi J518 Code 62 - SFS 90 - Solid one piece.....	100
H10W3320	Split Flange Clamp 3000 psi J518 Code 61 - FHL.....	100
H10W3620	Split Flange Clamp 6000 psi J518 Code 62 - FHS.....	101
H10W3310	4 Hole Flange Clamp 3000 psi J518 Code 61 - VHL.....	101
H10W3610	4 Hole Flange Clamp 6000 psi J518 Code 62 - VHS.....	101

// MULTISPIRAL FITTINGS**// FERRULES**

H1300NS4	Multispiral No-Skive Ferrule for 4 Spiral Hoses.....	103
H1300NS6	Multispiral No-Skive Ferrule for 6 Spiral Hoses.....	103
H1300SK4	Multispiral Skive Ferrule for Alfabiotech/Powerflexbio Hoses.....	103

// BSP INSERTS

H1310510	BSPP Male 60° Flare - AGR.....	104
H1320812	BSPP Female 60° Cone with O-Ring - DKOR.....	104
H1320842	45° BSPP Female 60° Cone with O-Ring - DKOR 45 - Solid one piece.....	104
H1320892	90° BSPP Female 60° Cone with O-Ring - DKOR 90 - Solid one piece.....	105

// DIN METRIC INSERTS

H1311210	Metric Male 24° Seat - DIN 3853 - Heavy Series - CES.....	106
H1321613	Metric Female 24° Cone with O-Ring - ISO 8434-1 - Heavy Series - DKOS.....	106
H1321643	45° Metric Female 24° Cone with O-Ring - ISO 8434-1 - Heavy Series - DKOS 45 - Solid one piece.....	106
H1321693	90° Metric Female 24° Cone with O-Ring - ISO 8434-1 - Heavy Series - DKOS 90 - Solid one piece.....	107

// JIC 37° INSERTS

H1312510	JIC Male 37° Cone - AGJ.....	108
H1322512	JIC Female 37° Seat - DKJ.....	108
H1322542	45° JIC Female 37° Seat - Medium Drop - DKJ 45M - Solid one piece.....	108
H1322592	90° JIC Female 37° Seat - Medium Drop - DKJ 90M - Solid one piece.....	109

// NPTF INSERTS

H1312810	NPTF Male 60° Seat - AGN.....	110
----------	-------------------------------	-----

// ORFS INSERTS

H1312410	ORFS Male.....	111
H1322411	ORFS Female with Stem Hexagon.....	111
H1322441	45° ORFS Female - Medium Drop - DK ORFS 45M - Solid one piece.....	111
H1322491	90° ORFS Female - Medium Drop - DK ORFS 90M - Solid one piece.....	112

// SAE FLANGES

H1343310	Flange SAE 3000 psi J518 Code 61 - SFL.....	113
H1343340	45° Flange SAE 3000 psi J518 Code 61 - SFL 45 - Solid one piece.....	113
H1343390	90° Flange SAE 3000 psi J518 Code 61 - SFL 90 - Solid one piece.....	114
H1343610	Flange SAE 6000 psi J518 Code 62 - SFS.....	114
H1343640	45° Flange SAE 6000 psi J518 Code 62 - SFS 45 - Solid one piece.....	115
H1343690	90° Flange SAE 6000 psi J518 Code 62 - SFS 90 - Solid one piece.....	115

// SUPERCAT FLANGES

H1343910	Flange SUPERCAT.....	116
H1343940	45° Flange SUPERCAT - Solid one piece.....	116
H1343990	90° Flange SUPERCAT - Solid one piece.....	116

// NEW INTERLOCK FITTINGS**// FERRULES**

H1700200	Interlock Dual Skive Ferrule for 4 Spiral Hoses.....	118
H1700301	Interlock Dual Skive Ferrule for 4-6 Spiral Hoses.....	118

// HOSE MENDER

H17C5610	Hose Mender.....	119
----------	------------------	-----

// BSP INSERTS

H1710510	BSPP Male 60° Flare - AGR.....	120
H1720812	BSPP Female 60° Cone with O-Ring - DKOR.....	120
H1720842	45° BSPP Female 60° Cone with O-Ring - DKOR 45 - Solid one piece.....	120
H1720892	90° BSPP Female 60° Cone with O-Ring - DKOR 90 - Solid one piece.....	121

// DIN METRIC INSERTS

H1711210	Metric Male 24° Seat - DIN 3853 - Heavy Series - CES.....	122
H1721613	Metric Female 24° Cone with O-Ring - ISO 8434-1 - Heavy Series - DKOS.....	122
H1721643	45° Metric Female 24° Cone with O-Ring - ISO 8434-1 - Heavy Series - DKOS - Solid one piece.....	123
H1721693	90° Metric Female 24° Cone with O-Ring - ISO 8434-1 - Heavy Series - DKOS 90 - Solid one piece.....	123

// JIC 37° INSERTS

H1712510	JIC Male 37° Cone - AGJ.....	124
H1722512	JIC Female 37° Seat - DKJ.....	124
H1722542	45° JIC Female 37° Seat - DKJ 45 - Solid one piece.....	125
H1722592	90° JIC Female 37° Seat - DKJ 90 - Solid one piece.....	125

// NPTF INSERTS

H1712810	NPTF Male 60° Seat - AGN.....	126
----------	-------------------------------	-----

// ORFS INSERTS

H1712410	ORFS Male.....	127
H1722411	ORFS Female with Stem Hexagon.....	127

H1722441	45° ORFS Female - DK ORFS 45 - Solid one piece.....	127
H1722491	90° ORFS Female - DK ORFS 90 - Solid one piece.....	128

// SAE FLANGES

H1743310	Flange SAE 3000 psi J518 Code 61 - SFL.....	129
H1743340	45° Flange SAE 3000 psi J518 Code 61 - SFL 45 - Solid one piece.....	129
H1743390	90° Flange SAE 3000 psi J518 Code 61 - SFL 90 - Solid one piece.....	129
H1743610	Flange SAE 6000 psi J518 Code 62 - SFS.....	130
H1743640	45° Flange SAE 6000 psi J518 Code 62 - SFS 45 - Solid one piece.....	130
H1743690	90° Flange SAE 6000 psi J518 Code 62 - SFS 90 - Solid one piece.....	131

// SUPERCAT FLANGES

H1743910	Flange SUPERCAT.....	132
H1743940	45° Flange SUPERCAT - Solid one piece.....	132
H1743990	90° Flange SUPERCAT - Solid one piece.....	132

// INTERLOCK FITTINGS**// FERRULES**

H1400200	Interlock Dual Skive Ferrule for 4 Spiral Hoses.....	134
H1400301	Interlock Dual Skive Ferrule for 4-6 Spiral Hoses.....	134
H1T00600	Interlock Dual Skive Ferrule for Alfabiotech/Powerflexbio 3K and AT8K.....	134

// HOSE MENDER

H14C5610	Hose Mender.....	135
----------	------------------	-----

// BSP INSERTS

H1410510	BSPP Male 60° Flare - AGR.....	136
H1410710	BSPT Male - AGR K.....	136
H1420812	BSPP Female 60° Cone with O-Ring - DKOR.....	136
H1420842	45° BSPP Female 60° Cone with O-Ring - DKOR 45 - Solid one piece.....	137
H1420892	90° BSPP Female 60° Cone with O-Ring - DKOR 90 - Solid one piece.....	137

// DIN METRIC INSERTS

H1411210	Metric Male 24° Seat - DIN 3853 - Heavy Series - CES.....	138
H1421613	Metric Female 24° Cone with O-Ring - ISO 8434-1 - Heavy Series - DKOS.....	138
H1421643	45° Metric Female 24° Cone with O-Ring - ISO 8434-1 - Heavy Series - DKOS - Solid one piece.....	139
H1421693	90° Metric Female 24° Cone with O-Ring - ISO 8434-1 - Heavy Series - DKOS 90 - Solid one piece.....	139

// JIC 37° INSERTS

H1412510	JIC Male 37° Cone - AGJ.....	140
H1422512	JIC Female 37° Seat - DKJ.....	140
H1422542	45° JIC Female 37° Seat - DKJ 45 - Solid one piece.....	141
H1422592	90° JIC Female 37° Seat - DKJ 90 - Solid one piece.....	141

// NPTF INSERTS

H1412810	NPTF Male 60° Seat - AGN.....	142
----------	-------------------------------	-----

// ORFS INSERTS

H1412410	ORFS Male.....	143
H1422411	ORFS Female with Stem Hexagon.....	143
H1422441	45° ORFS Female - DK ORFS 45 - Solid one piece.....	143
H1422491	90° ORFS Female - DK ORFS 90 - Solid one piece.....	144

// SAE FLANGES

H1443310	Flange SAE 3000 psi J518 Code 61 - SFL.....	145
H1443340	45° Flange SAE 3000 psi J518 Code 61 - SFL 45 - Solid one piece.....	145
H1443390	90° Flange SAE 3000 psi J518 Code 61 - SFL 90 - Solid one piece.....	145
H1443610	Flange SAE 6000 psi J518 Code 62 - SFS.....	146
H1443640	45° Flange SAE 6000 psi J518 Code 62 - SFS 45 - Solid one piece.....	146
H1443690	90° Flange SAE 6000 psi J518 Code 62 - SFS 90 - Solid one piece.....	147
H1T43610	Flange SAE 6000 psi J518 Code 62 - SFS - Special version.....	147
H1T43640	45° Flange SAE 6000 psi J518 Code 62 - SFS 45 - Solid one piece - Special version.....	147
H1T43690	90° Flange SAE 6000 psi J518 Code 62 - SFS 90 - Solid one piece - Special version.....	148

// SUPERCAT FLANGES

H1443910	Flange SUPERCAT.....	149
H1443940	45° Flange SUPERCAT - Solid one piece.....	149
H1443990	90° Flange SUPERCAT - Solid one piece.....	149

// HAMMER UNION

H1T13F13	Male Hammer Union Fig. 1502 Integral Fitting with Lug Nut - Special version.....	150
H1T23F10	Female Hammer Union Fig. 1502 Integral Fitting with Rubber Ring - Special version.....	150

// ALFACRIMP C12A - ONE PIECE - FITTINGS**// BSP INSERTS**

C12A10510	BSPP Male 60° Flare - AGR.....	152
C12A10710	BSPT Male - AGR K.....	152
C12A20813	BSPP Female 60° Cone with O-Ring - DKOR.....	153
C12A20843	45° BSPP Female 60° Cone with O-Ring - DKOR 45 - Solid one piece.....	153
C12A20893	90° BSPP Female 60° Cone with O-Ring - DKOR 90 - Solid one piece.....	154
C12A20581	90° Compact BSPP Female 60° Cone - DKR 90.....	154
C12A20613	BSPP Female Flat Seat - DKR FD.....	155

// DIN METRIC INSERTS

C12A11110	Metric Male 24° Seat - DIN 3853 - Light Series - CEL.....	156
C12A21513	Metric Female 24° Cone with O-Ring - ISO 8434-1 - Light Series - DKOL.....	156
C12A21543	45° Metric Female 24° Cone with O-Ring - ISO 8434-1 - Light Series - DKOL 45 - Solid one piece.....	157
C12A21593	90° Metric Female 24° Cone with O-Ring - ISO 8434-1 - Light Series - DKOL 90 - Solid one piece.....	157
C12A11210	Metric Male 24° Seat - DIN 3853 - Heavy Series - CES.....	158
C12A21613	Metric Female 24° Cone with O-Ring - ISO 8434-1 - Heavy Series - DKOS.....	158
C12A21643	45° Metric Female 24° Cone with O-Ring - ISO 8434-1 - Heavy Series - DKOS 45 - Solid one piece.....	159
C12A21693	90° Metric Female 24° Cone with O-Ring - ISO 8434-1 - Heavy Series - DKOS 90 - Solid one piece.....	159
C12A52010	Metric Straight Standpipe - DIN 2353 - RSL/RSS.....	160

// SAE INSERTS

C12A13B10	SAE Male Flareless.....	161
C12A26611	SAE Female Swivel 45° Seat.....	161
C12A13010	SAE Male Solid - O-Ring Boss.....	162
C12A13011	SAE Male Swivel O-Ring Boss.....	162
C12A13081	90° Compact SAE Male Swivel - O-Ring Boss.....	163

// JIC 37° INSERTS

C12A12510	JIC Male 37° Cone - AGJ.....	164
C12A22511	JIC Female 37° Seat - DKJ.....	165
C12A26511	JIC Female 37° Seat with Stem Hexagon - DKJ.....	166
C12A26514	JIC Female 37° Seat with double Hexagon - DKJ and solid nut.....	166
C12A22541-M	45° JIC Female 37° Seat - Medium Drop - DKJ 45M - Solid one piece.....	167
C12A26544-M	45° JIC Female 37° Seat - Medium Drop - DKJ 45M - Solid nut and double Hexagon crimped.....	167
C12A22591-S	90° JIC Female 37° Seat - Short Drop - DKJ 90S - Solid one piece.....	168
C12A26594-S	90° JIC Female 37° Seat - Short Drop - Solid Nut and double Hexagon crimped.....	168
C12A22591-M	90° JIC Female 37° Seat - Medium Drop - DKJ 90M - Solid one piece.....	169
C12A26594-M	90° JIC Female 37° Seat - Medium Drop - Solid Nut and double Hexagon crimped.....	169
C12A22591-L	90° JIC Female 37° Seat - Long Drop - DKJ 90L - Solid one piece.....	170
C12A26594-L	90° JIC Female 37° Seat - Long Drop - Solid Nut and double Hexagon crimped.....	170

// NPTF INSERTS

C12A12810	NPTF Male 60° Seat - AGN.....	171
C12A22810	NPTF Female Solid.....	171
C12A12811	NPTF Male Swivel 60° Seat.....	172
C12A12881	90° Compact NPTF Male Swivel 60° Seat.....	172

// NPSM INSERTS

C12A27311	NPSM Female.....	173
-----------	------------------	-----

// ORFS INSERTS

C12A12410	ORFS Male.....	174
C12A22414	ORFS Female with support Hexagon knurled.....	174
C12A22443-S	45° ORFS Female - Short Drop - DK ORFS 45M - Solid one piece.....	175
C12A22493-S	90° ORFS Female - Short Drop - DK ORFS 90S - Solid one piece.....	175
C12A22493-M	90° ORFS Female - Medium Drop - DK ORFS 90M - Solid one piece.....	176
C12A22493-L	90° ORFS Female - Long Drop - DK ORFS 90L - Solid one piece.....	176

// JIS INSERTS

C12A2381Z	JIS Female 60° Seat Flare - B 8363 (type F).....	177
-----------	--	-----

// KOMATSU INSERTS

C12A24011	Komatsu Female.....	178
-----------	---------------------	-----

// SAE FLANGES

C12A43310	Flange SAE 3000 psi J518 Code 61 - SFL.....	179
C12A43340	45° Flange SAE 3000 psi J518 Code 61 - SFL 45 - Solid one piece.....	179
C12A43390	90° Flange SAE 3000 psi J518 Code 61 - SFL 90 - Solid one piece.....	180
C12A43610	Flange SAE 6000 psi J518 Code 62 - SFS.....	180
C12A43640	45° Flange SAE 6000 psi J518 Code 62 - SFS 45 - Solid one piece.....	180
C12A43690	90° Flange SAE 6000 psi J518 Code 62 - SFS 90 - Solid one piece.....	181

// ALFACRIMP C124 - ONE PIECE - FITTINGS**// BSP INSERTS**

C12410510	BSPP Male 60° Flare - AGR.....	183
C12410710	BSPT Male - AGR K.....	183
C12420813	BSPP Female 60° Cone with O-Ring - DKOR.....	184
C12420843	45° BSPP Female 60° Cone with O-Ring - DKOR 45 - Solid one piece.....	184
C12420893	90° BSPP Female 60° Cone with O-Ring - DKOR 90 - Solid one piece.....	185

// DIN METRIC INSERTS

C12411110	Metric Male 24° Seat - DIN 3853 - Light Series - CEL.....	186
C12421513	Metric Female 24° Cone with O-Ring - ISO 8434-1 - Light Series - DKOL.....	186
C12421543	45° Metric Female 24° Cone with O-Ring - ISO 8434-1 - Light Series - DKOL 45 - Solid one piece.....	187
C12421593	90° Metric Female 24° Cone with O-Ring - ISO 8434-1 - Light Series - DKOL 90 - Solid one piece.....	187
C12411210	Metric Male 24° Seat - DIN 3853 - Heavy Series - CES.....	187
C12421613	Metric Female 24° Cone with O-Ring - ISO 8434-1 - Heavy Series - DKOS.....	188
C12421643	45° Metric Female 24° Cone with O-Ring - ISO 8434-1 - Heavy Series - DKOS 45 - Solid one piece.....	188
C12421693	90° Metric Female 24° Cone with O-Ring - ISO 8434-1 - Heavy Series - DKOS 90 - Solid one piece.....	189

// SAE INSERTS

C12413010	SAE Male Solid - O-Ring Boss.....	190
-----------	-----------------------------------	-----

// JIC 37° INSERTS

C12412510	JIC Male 37° Cone - AGJ.....	191
C12422511	JIC Female 37° Seat - DKJ.....	191
C12426511	JIC Female 37° Seat with Stem Hexagon - DKJ.....	192
C12426514	JIC Female 37° Seat with double Hexagon - DKJ and solid nut.....	192
C12422541-M	45° JIC Female 37° Seat - Medium Drop - DKJ 45M - Solid one piece.....	193
C12426544-M	45° JIC Female 37° Seat - Medium Drop - DKJ 45M - Solid nut and double Hexagon crimped.....	193
C12422591-S	90° JIC Female 37° Seat - Short Drop - DKJ 90S - Solid one piece.....	194
C12426594-S	90° JIC Female 37° Seat - Short Drop - Solid Nut and double Hexagon crimped.....	194
C12422591-M	90° JIC Female 37° Seat - Medium Drop - DKJ 90M - Solid one piece.....	195
C12426594-M	90° JIC Female 37° Seat - Medium Drop - Solid Nut and double Hexagon crimped.....	195
C12422591-L	90° JIC Female 37° Seat - Long Drop - DKJ 90L - Solid one piece.....	196
C12426594-L	90° JIC Female 37° Seat - Long Drop - Solid Nut and double Hexagon crimped.....	196

// NPTF INSERTS

C12412810	NPTF Male 60° Seat - AGN.....	197
C12422810	NPTF Female Solid.....	197
C12412811	NPTF Male Swivel 60° Seat.....	198

// ORFS INSERTS

C12412410	ORFS Male.....	199
C12422414	ORFS Female with support Hexagon knurled.....	199
C12422443-S	45° ORFS Female - Short Drop - DK ORFS 45M - Solid one piece.....	200
C12422493-S	90° ORFS Female - Short Drop - DK ORFS 90S - Solid one piece.....	200
C12422493-M	90° ORFS Female - Medium Drop - DK ORFS 90M - Solid one piece.....	201
C12422493-L	90° ORFS Female - Long Drop - DK ORFS 90L - Solid one piece.....	201

// SAE FLANGES

C12443310	Flange SAE 3000 psi J518 Code 61 - SFL.....	202
C12443340	45° Flange SAE 3000 psi J518 Code 61 - SFL 45 - Solid one piece.....	202
C12443390	90° Flange SAE 3000 psi J518 Code 61 - SFL 90 - Solid one piece.....	203
C12443610	Flange SAE 6000 psi J518 Code 62 - SFS.....	203
C12443640	45° Flange SAE 6000 psi J518 Code 62 - SFS 45 - Solid one piece.....	204
C12443690	90° Flange SAE 6000 psi J518 Code 62 - SFS 90 - Solid one piece.....	204

// C122 SAE FLANGES

C12243310	Flange SAE 3000 psi J518 Code 61 - SFL.....	205
C12243340	45° Flange SAE 3000 psi J518 Code 61 - SFL 45 - Solid one piece.....	205
C12243390	90° Flange SAE 3000 psi J518 Code 61 - SFL 90 - Solid one piece.....	205

// ALFACRIMP C126 - ONE PIECE - FITTINGS**// JIC 37° INSERTS**

C12626512	JIC Female 37° Seat with Stem Hexagon - DKJ.....	207
C12622542	45° JIC Female 37° Seat - DKJ 45 - Solid one piece.....	207
C12622592	90° JIC Female 37° Seat - DKJ 90 - Solid one piece.....	207

// NPTF INSERTS

C12612810	NPTF Male 60° Seat - AGN.....	208
-----------	-------------------------------	-----

// API INSERTS

C1261281Z	API Male - Extra Long Hexagon.....	209
-----------	------------------------------------	-----

// ORFS INSERTS

C12622411	ORFS Female with Stem Hexagon.....	210
C12622441	45° ORFS Female - DK ORFS 45 - Solid one piece.....	210
C12622491	90° ORFS Female - DK ORFS 90 - Solid one piece.....	210

// SAE FLANGES

C12643310	Flange SAE 3000 psi J518 Code 61 - SFL.....	211
C12643610	Flange SAE 6000 psi J518 Code 62 - SFS.....	211
C12643640	45° Flange SAE 6000 psi J518 Code 62 - SFS 45 - Solid one piece.....	212
C12643690	90° Flange SAE 6000 psi J518 Code 62 - SFS 90 - Solid one piece.....	212

// SUPERCAT FLANGES

C12643910	Flange SUPERCAT.....	213
C12643930	30° Flange SUPERCAT - Solid one piece.....	213
C12643940	45° Flange SUPERCAT - Solid one piece.....	213
C12643960	60° Flange SUPERCAT - Solid one piece.....	214
C12643920	67,5° Flange SUPERCAT - Solid one piece.....	214
C12643990	90° Flange SUPERCAT - Solid one piece.....	214

// HAMMER UNION

C12613F13	Male Hammer Union Fig. 1502 Integral Fitting with Lug Nut.....	215
C12623F10	Female Hammer Union Fig. 1502 Integral Fitting with Rubber Ring.....	215

// JIC 37° ADAPTERS**// MALE UNION**

R1A25M125M	Straight union JIC Male.....	217
R1A25M925M	90° union JIC Male.....	217
R1A25MT25M	Branch Tee union JIC Male.....	218
R1A25MX25M	Cross union JIC Male.....	218

// MALE/FEMALE UNION

R1A253125M	Straight reducing JIC Female - Male.....	219
R1A25M4251	45° union JIC Male - Female.....	219
R1A25M9251	90° union JIC Male - Female.....	220
R1A25MT251	Branch Tee union JIC Male - Female.....	220
R1A25ML251	Run Tee union JIC Male - Female.....	221

// BULKHEAD

R1A25M125T	Straight union JIC Bulkhead.....	222
R1A25M425T	45° union JIC Bulkhead.....	222
R1A25M925T	90° union JIC Bulkhead.....	223
R1A25MT25T	Branch Tee union JIC Bulkhead.....	223
R1A25ML25T	Run Tee union JIC Bulkhead.....	224

// BSPP-BSPT

R1A25M105M	Straight connector - JIC Male - BSP 60° Male.....	225
R1A25M106I	Straight connector - JIC Male - BSPP cylindric Male with elastomer.....	226
R1A25M106H	Long connector - JIC Male - BSPP cylindric Male with elastomer.....	227
R1A25M406N	45° adjustable elbow connector - JIC Male - BSPP cylindric Male with O-Ring and retaining ring.....	228
R1A25M906N	90° adjustable elbow connector - JIC Male - BSPP cylindric Male with O-Ring and retaining ring.....	229
R1A25M906Y	90° adjustable long elbow connector - JIC Male - BSPP cylindric Male with O-Ring and retaining ring.....	230
R1A25MT06N	Branch Tee adjustable elbow connector - JIC Male - BSPP cylindric Male with O-Ring and retaining ring.....	231
R1A25ML06N	Run Tee adjustable elbow connector - JIC Male - BSPP cylindric Male with O-Ring and retaining ring.....	232
R1A25M107M	Straight connector - JIC Male - BSPT Male.....	233
R1A25M907M	90° elbow connector - JIC Male - BSPT Male.....	234

// METRIC

R1A2511525	Straight connector - JIC Female - Metric Male with O-Ring.....	235
R1A25M1525	Straight connector - JIC Male - Metric Male with O-Ring.....	235
R1A25M152I	Straight connector - JIC Male - Metric Male with elastomer.....	236
R1A25M152H	Long connector - JIC Male - Metric Male with elastomer.....	236
R1A25M952Q	90° adjustable elbow connector - JIC Male - Metric Male with O-Ring and retaining ring.....	237
R1A25M952Y	90° adjustable long elbow connector - JIC Male - Metric Male with O-Ring and retaining ring.....	237
R1A25MT52Q	Branch Tee adjustable elbow connector - JIC Male - Metric Male with O-Ring and retaining ring.....	238
R1A25ML52Q	Run Tee adjustable elbow connector - JIC Male - Metric Male with O-Ring and retaining ring.....	238

// SAE UNF

R1A25M1305	Straight connector - JIC Male - SAE UNF/UN Male with O-Ring.....	239
------------	--	-----

R1A25M130J	Long connector - JIC Male - SAE UNF/UN Male with O-Ring.....	240
R1A2511305	Straight connector - JIC Female - SAE UNF/UN Male with O-Ring.....	240
R1A25M4305	45° adjustable elbow connector - JIC Male - SAE UNF/UN Male with O-Ring.....	241
R1A25M9305	90° adjustable elbow connector - JIC Male - SAE UNF/UN Male with O-Ring.....	242
R1A25M930J	90° adjustable long elbow connector - JIC Male - SAE UNF/UN Male with O-Ring.....	243
R1A25MT305	Branch Tee adjustable elbow connector - JIC Male - SAE UNF/UN Male with O-Ring.....	244
R1A25ML305	Run Tee adjustable elbow connector - JIC Male - SAE UNF/UN Male with O-Ring.....	245

// NPTF

R1A25M128M	Straight connector - JIC - NPTF Male.....	246
R1A251128M	Straight connector - JIC Female - NPTF Male.....	247
R1A25M428M	45° elbow connector - JIC - NPTF Male.....	247
R1A25M928M	90° elbow connector - JIC - NPTF Male.....	248

// FLANGES

R1A25M133W	Straight flange SAE J518 code 61 - JIC - Low pressure.....	249
R1A25M136W	Straight flange SAE J518 code 62 - JIC - High pressure.....	249
R1A25M933W	90° flange SAE J518 code 61 - JIC - Low pressure.....	250
R1A25M936W	90° flange SAE J518 code 62 - JIC - High pressure.....	250
R1A25M9334	90° adjustable split flange SAE J518 code 61 - JIC - Low pressure.....	251
R1A25M9364	90° adjustable split flange SAE J518 code 62 - JIC - High pressure.....	251

// ACCESSORIES

RXA25D0000	Nut JIC.....	252
R1A25R0000	Sleeve JIC.....	252

// PLUG

R1A2531000	Cap JIC Female.....	253
R1A25M1000	Plug JIC Male.....	253

// ORFS ADAPTERS**// MALE UNION**

R1A2451245	Straight union ORFS Male.....	255
R1A2459245	90° union ORFS Male.....	255
R1A245T245	Branch Tee union ORFS Male.....	256
R1A245X245	Cross union ORFS Male.....	256

// MALE/FEMALE UNION

R1A2431245	Straight union ORFS Female - Male.....	257
R1A2454241	45° union ORFS Male - Female.....	257
R1A2459241	90° union ORFS Male - Female.....	258
R1A245T241	Branch Tee union ORFS Male - Female.....	258
R1A245L241	Run Tee union ORFS Male - Female.....	259

// BULKHEAD

R1A245124T	Straight union ORFS Bulkhead.....	260
R1A245424T	45° union ORFS Bulkhead.....	260
R1A245924T	90° union ORFS Bulkhead.....	261
R1A245T24T	Branch Tee union ORFS Bulkhead.....	261
R1A245L24T	Run Tee union ORFS Bulkhead.....	262

// BSPP-BSPT

R1A245106I	Straight connector - ORFS Male - BSPP cylindric Male with elastomer.....	263
R1A245406N	45° adjustable elbow connector - ORFS Male - BSPP cylindric Male with O-Ring and retaining ring.....	264
R1A245906N	90° adjustable elbow connector - ORFS Male - BSPP cylindric Male with O-Ring and retaining ring.....	264
R1A245906Y	90° adjustable long elbow connector - ORFS Male - BSPP cylindric Male with O-Ring and retaining ring.....	265
R1A245T06N	Branch Tee adjustable elbow connector - ORFS Male - BSPP cylindric Male with O-Ring and retaining ring.....	265
R1A245L06N	Run Tee adjustable elbow connector - ORFS Male - BSPP cylindric Male with O-Ring and retaining ring.....	266

// METRIC

R1A2451525	Straight connector - ORFS Male - Metric Male with O-Ring.....	267
R1A245152I	Straight connector - ORFS Male - Metric Male with elastomer.....	268
R1A245452Q	45° adjustable elbow connector - ORFS Male - Metric Male with O-Ring and retaining ring.....	268
R1A245952Q	90° adjustable elbow connector - ORFS Male - Metric Male with O-Ring and retaining ring.....	269
R1A245952Y	90° adjustable long elbow connector - ORFS Male - Metric Male with O-Ring and retaining ring.....	269
R1A245T52Q	Branch Tee adjustable elbow connector - ORFS Male - Metric Male with O-Ring and retaining ring.....	270
R1A245L52Q	Run Tee adjustable elbow connector - ORFS Male - Metric Male with O-Ring and retaining ring.....	270

// SAE UNF

R1A2451305	Straight connector - ORFS Male - SAE UNF/UN Male with O-Ring.....	271
R1A245130J	Long connector - ORFS Male - SAE UNF/UN Male with O-Ring.....	271

R1A2411305	Straight connector - ORFS Female - SAE UNF/UN Male with O-Ring.....	272
R1A2454305	45° adjustable elbow connector - ORFS Male - SAE UNF/UN Male with O-Ring.....	272
R1A2459305	90° adjustable elbow connector - ORFS Male - SAE UNF/UN Male with O-Ring.....	273
R1A245930J	90° adjustable long elbow connector - ORFS Male - SAE UNF/UN Male with O-Ring.....	273
R1A245T305	Branch Tee adjustable elbow connector - ORFS Male - SAE UNF/UN Male with O-Ring.....	274
R1A245L305	Run Tee adjustable elbow connector - ORFS Male - SAE UNF/UN Male with O-Ring.....	274

// FLANGES

R1A245133W	Straight flange SAE J518 code 61 - ORFS Male - Low pressure.....	275
R1A245136W	Straight flange SAE J518 code 62 - ORFS Male - High pressure.....	275
R1A245933W	90° flange SAE J518 code 61 - ORFS Male - Low pressure.....	276
R1A245936W	90° flange SAE J518 code 62 - ORFS Male - High pressure.....	276
R1A2459334	90° adjustable flange SAE J518 code 61 - ORFS Male - Low pressure.....	277
R1A2459364	90° adjustable flange SAE J518 code 62 - ORFS Male - High pressure.....	277

// ACCESSORIES

HX0D2403	Nut ORFS.....	278
----------	---------------	-----

// PLUG

R1A2431000	Cap ORFS Female.....	279
R1A2451000	Plug ORFS Male.....	279

// BSP ADAPTERS**// MALE UNION**

R1A05M105M	Straight union BSP 60° Male.....	281
R1A05M905M	90° union BSP 60° Male.....	282
R1A05MT05M	Branch Tee union BSP 60° Male.....	282
R1A05MX05M	Cross union BSP 60° Male.....	283

// MALE/FEMALE UNION

R1A05M1051	Straight union BSP 60° Male - Female.....	284
R1A05M4051	45° union BSP 60° Male - Female.....	284
R1A05M9051	90° union BSP 60° Male - Female.....	285
R1A05MT051	Branch Tee union BSP 60° Male - Female.....	285
R1A05ML051	Run Tee union BSP 60° Male - Female.....	286

// FEMALE UNION

R1A0511051	Straight union BSP 60° Female.....	287
R1A0519051	90° union BSP 60° Female.....	287
R1A051T051	Branch Tee union BSP 60° Female.....	287

// BULKHEAD

R1A05M105T	Straight union BSP 60° Bulkhead.....	288
R1A05M905T	90° elbow connector BSP 60° Bulkhead.....	288
R1A05MT05T	Branch Tee union BSP 60° Bulkhead.....	289
R1A05ML05T	Run Tee union BSP 60° Bulkhead.....	289

// BSPP

R1A05M106N	Straight connector - BSP 60° Male - BSPP cylindric Male with O-Ring and retaining ring.....	290
R1A05M406N	45° adjustable elbow connector - BSP 60° Male - BSPP cylindric Male with O-Ring and retaining ring.....	291
R1A05M906N	90° adjustable elbow connector - BSP 60° Male - BSPP cylindric Male with O-Ring and retaining ring.....	291
R1A05MT06N	Branch Tee adjustable elbow connector - BSP 60° Male - BSPP cylindric Male with O-Ring and retaining ring.....	292
R1A05ML06N	Run Tee adjustable elbow connector - BSP 60° Male - BSPP cylindric Male with O-Ring and retaining ring.....	292

// FLANGES

R1A05M133W	Straight flange SAE J518 code 61 - BSP - Low pressure.....	293
R1A05M136W	Straight flange SAE J518 code 62 - BSP - High pressure.....	293
R1A05M933W	90° flange SAE J518 code 61 - BSP - Low pressure.....	294
R1A05M936W	90° flange SAE J518 code 62 - BSP - High pressure.....	294
R1A05M9334	90° adjustable flange SAE J518 code 61 - BSP - Low pressure.....	295
R1A05M9364	90° adjustable flange SAE J518 code 62 - BSP - High pressure.....	295

// PLUG

R1A0531000	Cap BSP 60° Female.....	296
R1A05M1000	Plug BSP 60° Male.....	296

// DIN 24° ADAPTERS

// ACCESSORIES

RXA11D0000	Nut DIN 24° - Light Series.....	298
RXA12D0000	Nut DIN 24° - Heavy Series.....	298
R1A11R0000	Double cutting ring DIN 24° - Light Series.....	299
R1A12R0000	Double cutting ring DIN 24° - Heavy Series.....	299
R1A11R000B	Double cutting ring with tight sealing DIN 24° - Light Series.....	300
R1A12R000B	Double cutting ring with tight sealing DIN 24° - Heavy Series.....	300

// MALE UNION

R1A11M111M	Straight union DIN 24° Male - Light Series.....	301
R1E11M111M	Straight union DIN 24° Male - Light Series - Complete.....	301
R1A12M112M	Straight union DIN 24° Male - Heavy Series.....	302
R1E12M112M	Straight union DIN 24° Male - Heavy Series - Complete.....	302
R1A11M911M	90° union DIN 24° Male - Light Series.....	303
R1E11M911M	90° union DIN 24° Male - Light Series - Complete.....	303
R1A12M912M	90° union DIN 24° Male - Heavy series.....	304
R1E12M912M	90° union DIN 24° Male - Heavy Series - Complete.....	304
R1A11MT11M	Branch Tee union DIN 24° Male - Light Series.....	305
R1E11MT11M	Branch Tee union DIN 24° Male - Light Series - Complete.....	305
R1A12MT12M	Branch Tee union DIN 24° Male - Heavy series.....	306
R1E12MT12M	Branch Tee union DIN 24° Male - Heavy Series - Complete.....	306
R1A11MX11M	Cross union DIN 24° Male - Light Series.....	307
R1E11MX11M	Cross union DIN 24° Male - Light Series - Complete.....	307
R1A12MX12M	Cross union DIN 24° Male - Heavy Series.....	308
R1E12MX12M	Cross union DIN 24° Male - Heavy Series - Complete.....	308

// MALE/FEMALE UNION

R1A11M1113	Reducers DIN 24° pre-assembled - Light Series.....	309
R1E11M1113	Reducers DIN 24° pre-assembled - Light Series - Complete.....	310
R1A12M1123	Reducers DIN 24° pre-assembled - Heavy Series.....	311
R1E12M1123	Reducers DIN 24° pre-assembled - Heavy Series - Complete.....	312
R1A11M1152	Reducers DIN 24° with O-Ring - Light Series.....	313
R1E11M1152	Reducers DIN 24° with O-Ring - Light Series - Complete.....	314
R1A12M1162	Reducers DIN 24° with O-Ring - Heavy Series.....	314
R1E12M1162	Reducers DIN 24° with O-Ring - Heavy Series - Complete.....	315
R1A11M4152	45° adjustable elbow connector - DIN 24° Male - Female with O-Ring - Light Series.....	316
R1E11M4152	45° adjustable elbow connector - DIN 24° Male - Female with O-Ring - Light Series - Complete.....	317
R1A12M4162	45° adjustable elbow connector - DIN 24° Male - Female with O-Ring - Heavy Series.....	317
R1E12M4162	45° adjustable elbow connector - DIN 24° Male - Female with O-Ring - Heavy Series - Complete.....	318
R1A11M9113	90° adjustable elbow connector - DIN 24° Male - Female pre-assembled - Light Series.....	318
R1E11M9113	90° adjustable elbow connector - DIN 24° Male - Female pre-assembled - Light Series - Complete.....	319
R1A12M9123	90° adjustable elbow connector - DIN 24° Male - Female pre-assembled - Heavy Series.....	319
R1E12M9123	90° adjustable elbow connector - DIN 24° Male - Female pre-assembled - Heavy Series - Complete.....	320
R1A11M9152	90° adjustable elbow connector - DIN 24° Male - Female with O-Ring - Light Series.....	320
R1E11M9152	90° adjustable elbow connector - DIN 24° Male - Female with O-Ring - Light Series - Complete.....	321
R1A12M9162	90° adjustable elbow connector - DIN 24° Male - Female with O-Ring - Heavy Series.....	321
R1E12M9162	90° adjustable elbow connector - DIN 24° Male - Female with O-Ring - Heavy Series - Complete.....	322
R1A11MT113	Branch Tee adjustable elbow connector - DIN 24° Male - Female pre-assembled - Light Series.....	322
R1E11MT113	Branch Tee adjustable elbow connector - DIN 24° Male - Female pre-assembled - Light Series - Complete.....	323
R1A12MT123	Branch Tee adjustable elbow connector - DIN 24° Male - Female pre-assembled - Heavy Series.....	323
R1E12MT123	Branch Tee adjustable elbow connector - DIN 24° Male - Female pre-assembled - Heavy Series - Complete.....	324
R1A11MT152	Branch Tee adjustable elbow connector - DIN 24° Male - Female with O-Ring - Light Series.....	324
R1E11MT152	Branch Tee adjustable elbow connector - DIN 24° Male - Female with O-Ring - Light Series - Complete.....	325
R1A12MT162	Branch Tee adjustable elbow connector - DIN 24° Male - Female with O-Ring - Heavy series.....	325
R1E12MT162	Branch Tee adjustable elbow connector - DIN 24° Male - Female with O-Ring - Heavy Series - Complete.....	326
R1A11ML113	Run Tee adjustable elbow connector - DIN 24° Male - Female pre-assembled - Light Series.....	326
R1E11ML113	Run Tee adjustable elbow connector - DIN 24° Male - Female pre-assembled - Light Series - Complete.....	327
R1A12ML123	Run Tee adjustable elbow connector - DIN 24° Male - Female pre-assembled - Heavy series.....	327
R1E12ML123	Run Tee adjustable elbow connector - DIN 24° Male - Female pre-assembled - Heavy Series - Complete.....	328
R1A11ML152	Run Tee adjustable elbow connector - DIN 24° Male - Female with O-Ring - Light Series.....	328
R1E11ML152	Run Tee adjustable elbow connector - DIN 24° Male - Female with O-Ring - Light Series - Complete.....	329
R1A12ML162	Run Tee adjustable elbow connector - DIN 24° Male - Female with O-Ring - Heavy Series.....	329
R1E12ML162	Run Tee adjustable elbow connector - DIN 24° Male - Female with O-Ring - Heavy Series - Complete.....	330

// BULKHEAD

R1A11T111M	Straight union DIN 24° Bulkhead - Light Series.....	331
R1E11T111M	Straight union DIN 24° Bulkhead - Light Series - Complete.....	331
R1A12T112M	Straight union DIN 24° Bulkhead - Heavy Series.....	332
R1E12T112M	Straight union DIN 24° Bulkhead - Heavy Series - Complete.....	332

R1A11T911M	90° union DIN 24° Bulkhead - Light Series.....	333
R1E11T911M	90° union DIN 24° Bulkhead - Light Series - Complete.....	333
R1A12T912M	90° union DIN 24° Bulkhead - Heavy Series.....	334
R1E12T912M	90° union DIN 24° Bulkhead - Heavy Series - Complete.....	334

// METRIC

R1A11M150M	Straight connector - DIN 24° Male - Metric cylindric Male - Light Series.....	335
R1E11M150M	Straight connector - DIN 24° Male - Metric cylindric Male - Light Series - Complete.....	335
R1A12M150M	Straight connector - DIN 24° Male - Metric cylindric Male - Heavy Series.....	336
R1E12M150M	Straight connector - DIN 24° Male - Metric cylindric Male - Heavy Series - Complete.....	336
R1A11M950M	90° elbow connector - DIN 24° Male - Metric cylindric Male - Light Series.....	337
R1E11M950M	90° elbow connector - DIN 24° Male - Metric cylindric Male - Light Series - Complete.....	337
R1A12M950M	90° elbow connector - DIN 24° Male - Metric cylindric Male - Heavy Series.....	337
R1E12M950M	90° elbow connector - DIN 24° Male - Metric cylindric Male - Heavy Series - Complete.....	338
R1A11M452Q	45° adjustable elbow connector - DIN 24° Male - Metric Male with O-Ring and retaining ring - Light Series.....	338
R1E11M452Q	45° adjustable elbow connector - DIN 24° Male - Metric Male with O-Ring and retaining ring - Light Series - Complete.....	339
R1A12M452Q	45° adjustable elbow connector - DIN 24° Male - Metric Male with O-Ring and retaining ring - Heavy Series.....	339
R1E12M452Q	45° adjustable elbow connector - DIN 24° Male - Metric Male with O-Ring and retaining ring - Heavy Series - Complete.....	340
R1A11M952Q	90° adjustable elbow connector - DIN 24° Male - Metric Male with O-Ring and retaining ring - Light Series.....	340
R1E11M952Q	90° adjustable elbow connector - DIN 24° Male - Metric Male with O-Ring and retaining ring - Light Series - Complete.....	341
R1A12M952Q	90° adjustable elbow connector - DIN 24° Male - Metric Male with O-Ring and retaining ring - Heavy Series.....	341
R1E12M952Q	90° adjustable elbow connector - DIN 24° Male - Metric Male with O-Ring and retaining ring - Heavy Series - Complete.....	342
R1A11MT52Q	Branch Tee adjustable elbow connector - DIN 24° Male - Metric Male with O-Ring and retaining ring - Light Series.....	342
R1E11MT52Q	Branch Tee adjustable elbow connector - DIN 24° Male - Metric Male with O-Ring and retaining ring - Light Series - Complete.....	343
R1A12MT52Q	Branch Tee adjustable elbow connector - DIN 24° Male - Metric Male with O-Ring and retaining ring - Heavy Series.....	343
R1E12MT52Q	Branch Tee adjustable elbow connector - DIN 24° Male - Metric Male with O-Ring and retaining ring - Heavy Series - Complete.....	344
R1A11ML52Q	Run Tee adjustable elbow connector - DIN 24° Male - Metric Male with O-Ring and retaining ring - Light Series.....	344
R1E11ML52Q	Run Tee adjustable elbow connector - DIN 24° Male - Metric Male with O-Ring and retaining ring - Light Series - Complete.....	345
R1A12ML52Q	Run Tee adjustable elbow connector - DIN 24° Male - Metric Male with O-Ring and retaining ring - Heavy Series.....	345
R1E12ML52Q	Run Tee adjustable elbow connector - DIN 24° Male - Metric Male with O-Ring and retaining ring - Heavy Series - Complete.....	346
R1A11M152I	Straight connector - DIN 24° Male Metric cylindric Male with elastomer - Light Series.....	346
R1E11M152I	Straight connector - DIN 24° Male Metric cylindric Male with elastomer - Light Series - Complete.....	347
R1A12M152I	Straight connector - DIN 24° Male - Metric cylindric Male with elastomer - Heavy Series.....	347
R1E12M152I	Straight connector - DIN 24° Male - Metric cylindric Male with elastomer - Heavy Series - Complete.....	348
R1A113152I	Straight connector - DIN 24° Female pre-assembled - Metric cylindric Male with elastomer - Light Series.....	348
R1E113152I	Straight connector - DIN 24° Female pre-assembled - Metric cylindric Male with elastomer - Light Series - Complete.....	349
R1A123152I	Straight connector - DIN 24° Female pre-assembled - Metric cylindric Male with elastomer - Heavy Series.....	349
R1E123152I	Straight connector - DIN 24° Female pre-assembled - Metric cylindric Male with elastomer - Heavy Series - Complete.....	349
R1A152152I	Straight connector - DIN 24° Female with O-Ring - Metric cylindric Male with elastomer - Light series.....	350
R1A162152I	Straight connector - DIN 24° Female with O-Ring - Metric cylindric Male with elastomer - Heavy series.....	350
R1A11M962M	90° elbow connector - DIN 24° Male - Metric conic Male - Light Series.....	351
R1E11M962M	90° elbow connector - DIN 24° Male - Metric conic Male - Light Series - Complete.....	351
R1A12M962M	90° elbow connector - DIN 24° Male - Metric conic Male - Heavy Series.....	351
R1E12M962M	90° elbow connector - DIN 24° Male - Metric conic Male - Heavy Series - Complete.....	352
R1A11ME505	Banjo adjustable - Type A - Metric cylindric DIN 24° - Light Series.....	352
R1E11ME505	Banjo adjustable - Type A - Metric cylindric DIN 24° - Light Series - Complete.....	352
R1A12ME505	Banjo adjustable - Type A Metric cylindric - DIN 24° - Heavy Series.....	353
R1E12ME505	Banjo adjustable - Type A Metric cylindric - DIN 24° - Heavy Series - Complete.....	353
R1A11ME50M	Banjo adjustable - Type B Metric cylindric - DIN 24° - Light Series.....	354
R1E11ME50M	Banjo adjustable - Type B Metric cylindric - DIN 24° - Light Series - Complete.....	354
R1A12ME50M	Banjo adjustable - Type B Metric cylindric - DIN 24° - Heavy Series.....	355
R1E12ME50M	Banjo adjustable - Type B Metric cylindric - DIN 24° - Heavy Series - Complete.....	355

// BSPP

R1A11M106M	Straight connector - DIN 24° Male - BSPP cylindric flat Male - Light Series.....	356
R1E11M106M	Straight connector - DIN 24° Male - BSPP cylindric flat Male - Light Series - Complete.....	357
R1A12M106M	Straight connector - DIN 24° Male - BSPP cylindric flat Male - Heavy Series.....	357
R1E12M106M	Straight connector - DIN 24° Male - BSPP cylindric flat Male - Heavy Series - Complete.....	358
R1A11M106F	Straight connector - DIN 24° Male - BSPP cylindric Female - Light Series.....	358
R1E11M106F	Straight connector - DIN 24° Male - BSPP cylindric Female - Light Series - Complete.....	359
R1A12M106F	Straight connector - DIN 24° Male - BSPP cylindric Female - Heavy Series.....	359
R1E12M106F	Straight connector - DIN 24° Male - BSPP cylindric Female - Heavy Series - Complete.....	360
R1A11M106I	Straight connector - DIN 24° Male - BSPP cylindric Male with elastomer - Light Series.....	360
R1E11M106I	Straight connector - DIN 24° Male - BSPP cylindric Male with elastomer - Light Series - Complete.....	361
R1A12M106I	Straight connector - DIN 24° Male - BSPP cylindric Male with elastomer - Heavy Series.....	361
R1E12M106I	Straight connector - DIN 24° Male - BSPP cylindric Male with elastomer - Heavy Series - Complete.....	362
R1A11M406N	45° adjustable elbow connector - DIN 24° Male - BSPP cylindric Male with O-Ring and retaining ring - Light Series.....	362
R1E11M406N	45° adjustable elbow connector - DIN 24° Male - BSPP cylindric Male with O-Ring and retaining ring - Light Series - Complete.....	363
R1A12M406N	45° adjustable elbow connector - DIN 24° Male - BSPP cylindric Male with O-Ring and retaining ring - Heavy Series.....	363
R1E12M406N	45° adjustable elbow connector - DIN 24° Male - BSPP cylindric Male with O-Ring and retaining ring - Heavy Series - Complete.....	364
R1A11M906N	90° adjustable elbow connector - DIN 24° Male - BSPP cylindric Male with O-Ring and retaining ring - Light Series.....	364

R1E11M906N	90° adjustable elbow connector - DIN 24° Male - BSPP cylindric Male with O-Ring and retaining ring - Light Series - Complete	365
R1A12M906N	90° adjustable elbow connector - DIN 24° Male - BSPP cylindric Male with O-Ring and retaining ring - Heavy Series	365
R1E12M906N	90° adjustable elbow connector - DIN 24° Male - BSPP cylindric Male with O-Ring and retaining ring - Heavy Series - Complete	366
R1A11MT06N	Branch Tee adjustable elbow connector - DIN 24° Male - BSPP Male with O-Ring and retaining ring - Light Series	366
R1E11MT06N	Branch Tee adjustable elbow connector - DIN 24° Male - BSPP Male with O-Ring and retaining ring - Light Series - Complete	367
R1A12MT06N	Branch Tee adjustable elbow connector - DIN 24° Male - BSPP Male with O-Ring and retaining ring - Heavy Series	367
R1E12MT06N	Branch Tee adjustable elbow connector - DIN 24° Male - BSPP Male with O-Ring and retaining ring - Heavy Series - Complete	368
R1A11ML06N	Run Tee adjustable elbow connector - DIN 24° Male - BSPP Male with O-Ring and retaining ring - Light Series	368
R1E11ML06N	Run Tee adjustable elbow connector - DIN 24° Male - BSPP Male with O-Ring and retaining ring - Light Series - Complete	369
R1A12ML06N	Run Tee adjustable elbow connector - DIN 24° Male - BSPP Male with O-Ring and retaining ring - Heavy Series	369
R1E12ML06N	Run Tee adjustable elbow connector - DIN 24° Male - BSPP Male with O-Ring and retaining ring - Heavy Series - Complete	370
R1A152106I	Straight connector - DIN 24° Female with O-Ring - BSPP cylindric Male with elastomer - Light series	370
R1A162106I	Straight connector - DIN 24° Female with O-Ring - BSPP cylindric Male with elastomer - Heavy series	371
R1A113106I	Straight connector - DIN 24° Female pre-assembled - BSPP cylindric Male with elastomer - Light Series	371
R1E113106I	Straight connector - DIN 24° Female pre-assembled - BSPP cylindric Male with elastomer - Light Series - Complete	372
R1A123106I	Straight connector - DIN 24° Female pre-assembled - BSPP cylindric Male with elastomer - Heavy Series	372
R1E123106I	Straight connector - DIN 24° Female pre-assembled - BSPP cylindric Male with elastomer - Heavy Series - Complete	373
R1A11ME06M	Banjo elbow - Type B - BSPP Male DIN 24° - Light Series	373
R1E11ME06M	Banjo elbow - Type B - BSPP Male DIN 24° - Light Series - Complete	374
R1A12ME06M	Banjo elbow - Type B - BSPP Male - DIN 24° - Heavy Series	374
R1E12ME06M	Banjo elbow - Type B - BSPP Male - DIN 24° - Heavy Series - Complete	375
R1A11ME035	Banjo elbow - Type A - BSPP Male - DIN 24° - Light Series	375
R1E11ME035	Banjo elbow - Type A - BSPP Male - DIN 24° - Light Series - Complete	376
R1A12ME035	Banjo elbow - Type A - BSPP Male with O-Ring - DIN 24° - Heavy series	376
R1E12ME035	Banjo elbow - Type A - BSPP Male - DIN 24° - Heavy Series - Complete	376
R1A06F106I	Straight connector - BSPP Female - BSPP Male with elastomer	377

// BSPT

R1A11M107M	Straight connector - DIN 24° Male - BSPT cylindric flat Male - Light Series	378
R1E11M107M	Straight connector - DIN 24° Male - BSPT cylindric flat Male - Light Series - Complete	379
R1A12M107M	Straight connector - DIN 24° Male - BSPT cylindric flat Male - Heavy Series	379
R1E12M107M	Straight connector - DIN 24° Male - BSPT cylindric flat Male - Heavy Series - Complete	380
R1A11M907M	90° connector - DIN 24° Male - BSPT Male - Light Series	380
R1E11M907M	90° connector - DIN 24° Male - BSPT Male - Light Series - Complete	381
R1A12M907M	90° connector - DIN 24° Male - BSPT Male - Heavy Series	381
R1E12M907M	90° connector - DIN 24° Male - BSPT Male - Heavy Series - Complete	382
R1A11MT07M	Branch Tee connector - DIN 24° Male - BSPT Male - Light Series	382
R1E11MT07M	Branch Tee connector - DIN 24° Male - BSPT Male - Light Series - Complete	383
R1A12MT07M	Branch Tee connector - DIN 24° Male - BSPT Male - Heavy Series	383
R1E12MT07M	Branch Tee connector - DIN 24° Male - BSPT Male - Heavy Series - Complete	384
R1A11ML07M	Run Tee connector - DIN 24° Male - BSPT Male - Light Series	384
R1E11ML07M	Run Tee connector - DIN 24° Male - BSPT Male - Light Series - Complete	385
R1A12ML07M	Run Tee connector - DIN 24° Male - BSPT Male - Heavy Series	385
R1E12ML07M	Run Tee connector - DIN 24° Male - BSPT Male - Heavy Series - Complete	386

// BUTT WELD

R1A11M100S	Butt Weld straight coupling DIN 24° - Light Series	387
R1E11M100S	Butt Weld straight coupling DIN 24° - Light Series - Complete	387
R1A12M100S	Butt Weld straight coupling DIN 24° - Heavy Series	388
R1E12M100S	Butt Weld straight coupling DIN 24° - Heavy Series - Complete	388
R1A11M111S	Butt Weld long straight coupling DIN 24° - Light Series	389
R1E11M111S	Butt Weld long straight coupling DIN 24° - Light Series - Complete	389
R1A12M112S	Butt Weld long straight coupling DIN 24° - Heavy Series	390
R1E12M112S	Butt Weld long straight coupling DIN 24° - Heavy Series - Complete	390

// PLUG

R1A15F0000	Plug with O-Ring DIN 24° - Light Series	391
R1A16F0000	Plug with O-Ring DIN 24° - Heavy Series	391
R1A50I0000	Socket head plug Metric cylindric with elastomer	392
R1A06I0000	Socket head plug BSPP cylindric with elastomer	392

// NOTES

Lined area for notes with horizontal dotted lines.

LIMITED WARRANTY (NORTH AMERICAN MARKET ONLY)

The Products sold or distributed by Seller are warranted to its customers to be free from defects in material and workmanship at the time of shipment by us, subject to the following provisions:

All warranty claims shall be made within six (6) months after the seller has shipped the products. The seller's liability and customer's remedy hereunder, under any theory of law or equity, including without limitation, for breach of contract, negligence, or otherwise, is limited, at seller's exclusive discretion, solely to 1) the purchase price of any products proving defective; 2) repair of any defective product or part thereof; or 3) replacement of any defective product or part upon its authorized return to seller.

This warranty is in lieu of and excludes, without limitation and to the fullest extent allowable by law, all other warranties or conditions, expressed, implied, statutory, or otherwise created under applicable law including, but not limited to, the warranty of merchantability, the warranty of fitness for a particular purpose, conditions of satisfactory quality, any obligation or warranty to remote purchasers, and those from a course of dealing or usage of trade.

In addition, this warranty shall not apply to any products, or portions thereof, that have been subjected to abuse, misuse, improper installation, maintenance, or operation, electrical failure or abnormal conditions and to products that have been tampered with, altered, modified, repaired, reworked by anyone not approved by seller, or used in any manner inconsistent with any instructions or specifications provided with or for the product.

In no event shall seller, or the manufacturer of the product, have any liability whatsoever to any person, including without limitation, any immediate buyer, remote purchaser, or other third party, for any special, punitive, incidental, or consequential damages, including without limitation, loss of profits of customer or any other person, loss or damage to physical property of customer or any other person, and loss of anticipated revenue, profits, goodwill, savings, or other economic loss of customer or any other person, even if advised of the possibility thereof in advance, whether or not arising in, caused by, or resulting from, breach of contract, the negligence of seller and/or the manufacturer of the product, or otherwise, unless specifically provided herein and except any liability that cannot be excluded or limited by applicable law.

There are no warranties that extend beyond the description on the face hereof.

THE ALFAGOMMA GROUP

ALFAGOMMA

ARGENTINA – Buenos Aires
Moreno Store Center
Belisario Roldán 2616 - CP. 1744
La Reja - Bs. As.
+54 (11) 5365-6062/6063

AUSTRALIA – Sydney
50 Honeycomb Drive
Eastern Creek
Sydney, NSW 2766
+61 (2) 98 53 09 00
sydney@alfagomma.com.au

BELGIUM & NETHERLANDS – Benelux
Koeweideblock 4/D3
1785 Merchtem
+32 (0)52 509 747
info.benelux@alfagomma.com

BRAZIL – Guaranésia
Rua Felice Gennasio 401
Distrito Indl. Dr. Firmino Rocha de Freitas
37810-000 - Guaranésia, MG - Brasil
+55 (35) 35 55 0408
contato@alfagomma.com.br

CANADA – Montreal
6550 Abrams
St. Laurent, Montreal
Quebec H4S 1Y2
+1 (514) 33 35 577
info@alfagomma.ca

CHINA – Ningbo
No. 1 Cidong South Avenue
Coastal Economic Development Zone
Cixi, Zhejiang, China 315311
+86 (574) 88 15 72 88
alfagomma.china@alfagomma.com.cn

FRANCE – Villepinte
Le Sisley – Parc d'activité Paris Nord 2
23 Allée des Impressionnistes
93420 Villepinte
+33 (1) 48172121
agfrance.info@alfagomma.com

GERMANY – Herne
Friedrich der Grosse 10
44628 Herne
+49 (2323) 14 730
info.germany@alfagomma.com

GREECE – Athens
85 Kifissou Avenue
12241 Aigaleo, Athens
+30 (210) 41 19 909
info.hellas@alfagomma.com

INDONESIA – Tigaraksa
JL. Raya Pemda Tigaraksa km. 4
No 34, Matagara
Tigaraksa, Tangerang 15720
+62 (21) 59 96 301
jakarta@alfagomma.co.id

ITALY – Vimercate
Via Torri Bianche 1
20871 Vimercate (MB)
+39 (039) 60 161
info@alfagomma.com

MALAYSIA – Pasir Gudang
Plo 405, Jalan Perak 4
81707 Pasir Gudang
Negeri Johor Darul Takzim
+60 (7) 25 72 000
alfagomma@alfagomma.com.my

MEXICO – Torreón
Av. Industria de la transformacion
Parque Pymes 585
27400 Torreón, Coahuila
+52 8713125026
alfagomma.mexico@alfagomma.com

SINGAPORE
14 Tuas Ave 11
Singapore 639080
+65 6360 9000
alfagomma@alfagomma.com.sg

SOUTH AFRICA – Johannesburg
17 Quark Crescent Linbro Business Park
Sandton 2065
+27 (11) 20 10 900
alfagomma@alfagomma.co.za

SOUTH KOREA – Hwasung
15 Julteo Gil
Yangkam-Myun, Hwasung-Si
Kyungki-Do 18630
+82 (31) 35 28 671
alfagomma@alfagomma.co.kr

THAILAND – Bangkok
60/21 Moo.4 King Kaew Road
Racha Thewa SubDistrict, Bang Phli District
Samut Prakan Province, 10540
+66 (0) 2 136 2388
sales@alfagomma.co.th

UNITED KINGDOM – Haydock
43 Wilcock Road
Old Boston Trading Estate Haydock
St. Helens WA11 9TG
+44 (1942) 40 76 80
haydock.sales@alfagomma.com

UNITED STATES OF AMERICA – Burlington
3520 West Avenue
IA 52601 Burlington
+1 (319) 75 89 224
info@alfagomma.us

DUNLOPHIFLEX

DENMARK – KOLDING
Kokholm 5
6000 Kolding
+45 (43) 25 40 00
kundeservice@dunlophiflex.dk

ESTONIA – Tallin
Läike tee 32/1 - Peetri alevik,
Rae vald - 75312 Harjumaa (Tallinn)
Tel: +372 (0) 605 4900
tallinn@dunlophiflex.ee

FINLAND – Pirkkala
Jasperintie 320
33960 Pirkkala
+358 (207) 625 700
info@dunlophiflex.fi

NORWAY – Kjeller
Jogstadveien 39
Pb. 7, 2027 Kjeller
2007 Kjeller
+47 (23) 00 47 00
sales@dunlophiflex.no

SWEDEN – Halmstad
Seldonsvägen 2
302 62 Halmstad
+46 (0)10 414 44 00
info@dunlophiflex.se

ARGUS

GERMANY – Ettlingen
Pforzheimer Str. 126
76275 Ettlingen
+49 (7243) 50 550
info@argus-fluidtechnik.de

UNITED KINGDOM – Salisbury
Telford Road
Salisbury, Wiltshire SP2 7PH
+44 (1722) 42 05 90
sales@hiflex-europe.com

KIOWA

UNITED KINGDOM – Sleaford
Kiowa Ltd, The Reservation, East Road
Sleaford, Lincolnshire, NG34 7BY
+44 (0) 1529 416200
sales@kiowa.co.uk



HEADQUARTER
Alfagomma SpA
Via Torri Bianche 1
20871 Vimercate (MB) Italy
marketing@alfagomma.com
www.alfagomma.com